

BEARINGS CATALOGUE

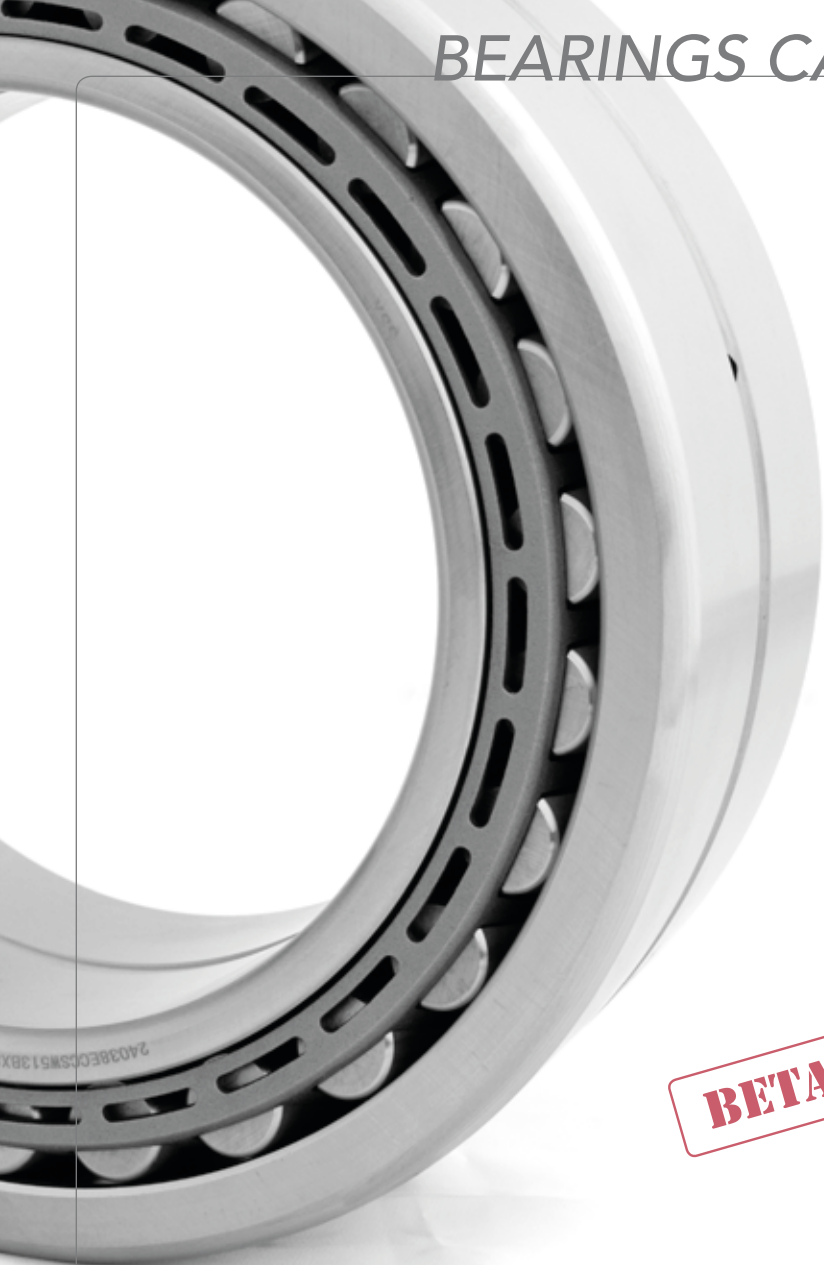

BETA VERSION



RKB
BEARING INDUSTRIES

Publication **BCRKB.Rev01EN**

© RKB Europe SA 2016

Every care has been taken to ensure the accuracy of the information in the present document but no liability can be accepted for any errors, omissions, losses and damages (direct, indirect, consequential).

Reproduction in whole or in part without our authorization is prohibited.







Table of Contents

Main prefixes and suffixes	3
Ball bearings	8
Ball bearings	11
Deep groove ball bearings.....	11
Angular contact ball bearings	39
Single row angular contact ball bearings	39
Double row angular contact ball bearings.....	49
Four-point contact ball bearings.....	59
Cylindrical roller bearings	68
Cylindrical roller bearings.....	71
Single row cylindrical roller bearings.....	71
Single row full complement cylindrical roller bearing.....	75
Double row cylindrical roller bearings.....	103
Double row full complement cylindrical roller bearing	103
Multi row cylindrical roller bearings.....	125
Tapered roller bearings	142
Tapered roller bearings.....	145
Single row tapered roller bearings.....	145
Double row tapered roller bearings	183
Four-row tapered roller bearings.....	207
Spherical roller bearings	244
Spherical roller bearings	245
Toroidal roller bearings	272
Toroidal roller bearings.....	273
Thrust bearings	290
Thrust ball bearings.....	293
Single direction thrust ball bearings.....	293
Double direction thrust ball bearings.....	307
Cylindrical roller thrust bearings	311
Single direction cylindrical roller thrust bearings.....	311
Double direction cylindrical roller thrust bearings.....	321
Tapered roller thrust bearings	323
Single direction tapered roller thrust bearings.....	323
Double direction tapered roller thrust bearings.....	337
Spherical roller thrust bearings.....	341
Single direction spherical roller thrust bearings.....	341

Main prefixes and suffixes

Prefixes	
GS	Housing washer of cylindrical roller thrust bearings
K	Cylindrical roller and cage thrust assembly
L	Separable bearing ring, including possible loose lips of separable roller bearings. Also, separable bearing rings which consist of several parts
R	Bearing ring with rolling element and cage assembly of separable roller bearings or needle roller bearings
WS	Shaft washer of cylindrical roller thrust bearings

Tab. 1 - Prefixes

Suffixes	Internal design
A...Z 1...n	Modification code to the bearing. Typically placed at the end of the part number, the meaning of these characters is not specifically fixed (e.g. modified internal design or configuration, special production protocol, application optimized version, filled with non-standard grease or other special feature). The actual modification to the original design is specific to the individual bearing and is provided on the related drawing. Combinations of letters and digits are also used (e.g. AC, A2). Sometimes, this type of suffix is preceded by an oblique stroke (e.g. /4)
E	Optimized internal design with reinforced execution
SP	Special or non-standard bearing
AOB	Application optimized bearing

Tab. 2 - Suffixes: internal design

Suffixes	External design
K	Tapered bore, taper 1:12
K30	Tapered bore, taper 1:30
ZB	Optimized roller profile for improved load distribution. It is not necessarily stated in the bearing code

Tab. 3 - Suffixes: external design

Suffixes	Set
DB	Two bearings matched for mounting back-to-back
DF	Two bearings matched for mounting face-to-face
DT	Two bearings matched for mounting in tandem
2x...	Pair of two bearings
3x...	Group of three bearings
SET 2x...	Set of two bearings with possible presence of spacers
SET 3x...	Set of three bearings with possible presence of spacers

Tab. 4 - Suffixes: set

Suffixes	Materials and heat treatments
HB1	Bainite hardened outer and inner ring
HB2	Bainite hardened outer ring
HB3	Bainite hardened inner ring
HB4	Bainite hardened outer and inner ring and rolling elements
HB5	Bainite hardened rolling elements
HB6	Bainite hardened outer ring and rolling elements
HB7	Bainite hardened inner ring and rolling elements
HA1	Case hardened outer and inner ring
HA2	Case hardened outer ring
HA3	Case hardened inner ring
HA4	Case hardened outer and inner ring and rolling elements
HA5	Case hardened rolling elements
HA6	Case hardened outer ring and rolling elements
HA7	Case hardened inner ring and rolling elements

Tab. 5 - Suffixes: materials and heat treatments

Suffixes	Special surface treatments
AWT1	Anti-wear treated outer and inner ring
AWT2	Anti-wear treated outer ring
AWT3	Anti-wear treated inner ring
AWT4	Anti-wear treated outer and inner ring and rolling elements
AWT5	Anti-wear treated rolling elements
AWT6	Anti-wear treated outer ring and rolling elements
AWT7	Anti-wear treated inner ring and rolling elements
PT1	Phosphate treated outer and inner ring
PT2	Phosphate treated outer ring
PT3	Phosphate treated inner ring
PT4	Phosphate treated outer and inner ring and rolling elements
PT5	Phosphate treated rolling elements
PT6	Phosphate treated outer ring and rolling elements
PT7	Phosphate treated inner ring and rolling elements
ACT1	Anti-corrosion treated outer and inner ring
ACT2	Anti-corrosion treated outer ring
ACT3	Anti-corrosion treated inner ring

Tab. 6 - Suffixes: special surface treatments

Suffixes	Dimensional stabilizing
S0	Bearing rings heat stabilized for operating temperatures up to 150 °C (300 °F)
S1	Bearing rings heat stabilized for operating temperatures up to 200 °C (390 °F)
S2	Bearing rings heat stabilized for operating temperatures up to 250 °C (480 °F)
S3	Bearing rings heat stabilized for operating temperatures up to 300 °C (570 °F)

Tab. 7 - Suffixes: dimensional stabilizing

Suffixes	Dimensional and running accuracy, clearance
ABEC1	Approximated to tolerance class P0
ABEC3	Approximated to tolerance class P6
ABEC5	Approximated to tolerance class P5
ST	Special tolerance
C1	Radial internal clearance smaller than C2
C2	Radial internal clearance smaller than Normal
CN	Normal radial internal clearance
C3	Radial internal clearance greater than Normal
C4	Radial internal clearance greater than C3
C5	Radial internal clearance greater than C4
C...S	Special radial internal clearance in a given range of the stated class
C...SL	Special radial internal clearance in the lower part of the stated class (e.g. C4SL = radial internal clearance in the lower part of C4)
C...ST	Special radial internal clearance in the upper part of the stated class (e.g. C4ST = radial internal clearance in the upper part of C4)
C...R	Radial internal clearance between upper part of previous class and lower part of the stated class (e.g. C4R = radial internal clearance between upper part of C3 and lower part of C4)
CS	Special radial internal clearance
P0	Dimensional and running accuracy to ISO tolerance class 0
P5	Dimensional and running accuracy to ISO tolerance class 5
P6	Dimensional and running accuracy to ISO tolerance class 6
P6S	Dimensional and running accuracy between P6 and P5
P51	P5 + C1
P52	P5 + C2
P53	P5 + C3
P54	P5 + C4
P55	P5 + C5
P61	P6 + C1
P62	P6 + C2
P63	P6 + C3
P64	P6 + C4
P65	P6 + C5
P62R	P6 + radial internal clearance between upper part of C1 and lower part of C2
P63R	P6 + radial internal clearance between upper part of normal and lower part of C3
P64R	P6 + radial internal clearance between upper part of C3 and lower part of C4
P65R	P6 + radial internal clearance between upper part of C4 and lower part of C5
SP	Special precision class

Tab. 8 - Suffixes: dimensional and running accuracy, clearance

Suffixes	Other
VL	Victory Line: combination of state-of-the-art bearing features to meet the ever-demanding requirements of modern machinery. It is a combination of factors connected to internal geometry, surface finish, cage design, steel cleanliness, advanced heat treatments, and optimization of rolling element/raceway contact. It is not necessarily stated in the bearing code

Tab. 9 - Suffixes: other

Bearing designation	Decoding
6315 MC4S2	<ul style="list-style-type: none"> • bearing type 6: deep groove ball bearing • dimension series 03: width series 0 and diameter series 3 • bore diameter code 15: bore diameter $15 \times 5 = 75$ mm • cage type code M: machined brass cage guided on rolling elements • precision class: P0 • radial internal clearance: C4 • special suffix S2: rings heat stabilized for operating temperatures up to 250 °C
N 1964 KMP62ZB	<ul style="list-style-type: none"> • bearing type N: single row cylindrical roller bearing • dimension series 19: width series 1 and diameter series 9 • bore diameter code 64: bore diameter $64 \times 5 = 320$ mm • ring design K: tapered bore, taper 1:12 • cage type code M: machined brass cage guided on rolling elements • precision class: P6 • radial internal clearance: C2 • special suffix ZB: optimized roller profile
24130 K30CAW33S1	<ul style="list-style-type: none"> • bearing type 2: double row spherical roller bearing • dimension series 41: width series 4 and diameter series 1 • bore diameter code 30: bore diameter $30 \times 5 = 150$ mm • ring design K30: tapered bore, taper 1:30 • cage type code CA: one-piece double pronged machined brass cage. Bearing with symmetrical roller and retaining ribs • special suffix W33: annular groove and three lubrication holes in the outer ring • special suffix S1: rings heat stabilized for operating temperatures up to 200 °C
293/600 EM	<ul style="list-style-type: none"> • bearing type 2: spherical roller bearing (thrust) • dimension series 93: height series 9 and diameter series 3 • bore diameter 600 mm • bearing design E: optimized internal design with reinforced execution • cage type code M: machined brass cage guided on shaft washer with or without retaining sleeve

Tab. 10 - Bearing designation examples



Ball bearings	11
Deep groove ball bearings	11
Bearings with contact seals	11
Internal clearance	11
Misalignment	12
Minimum load	12
Axial load carrying capacity	12
Designs and variants	14
Type J	14
Type TN	14
Type M	14
Seal type ZZ	14
Seal type 2RS	14
Prefixes	15
Suffixes	15
Product tables	17
Angular contact ball bearings	39
Single row angular contact ball bearings	39
Misalignment	39
Minimum load	39
Designs and variants	40
Type M	40
Type DB	40
Type DF	40
Prefixes	41
Suffixes	41
Product tables	43
Double row angular contact ball bearings	49
Misalignment	49
Minimum load	49
Designs and variants	50
Type DF	50

Type DB	50
Seal type DB/ZZ.....	50
Type DB/2RS	50
Suffixes.....	51
Product tables.....	53
Four-point contact ball bearings.....	59
Misalignment.....	59
Minimum load.....	59
Designs and variants	60
Type Q.....	60
Type QJ.....	60
Suffixes.....	61
Product tables.....	63

RKB
BEARING INDUSTRIES
SWITZERLAND

Ball bearings

The ball bearings (BBs) manufactured by RKB come in many designs, dimensions and series. They are conceived to withstand combined loads and high speeds, covering most requirements in a number of standard and special industrial applications. All RKB BBs are made from high quality materials and special heat treatments for superior performance.

Available in single and double row configuration, in open or sealed version, they are low-maintenance, which makes them an irreplaceable cost-effective solution in many cases.

For large size BBs, RKB can also apply Bainite Hardening Treatment (HB) and High Temperature Dimensional Stabilization (S) on rings and balls. The bearing dimensional and running accuracy conforms to ISO/ABMA/GOST specifications.



Deep groove ball bearings

RKB offers a wide range of deep groove ball bearings (DGGBs) in single row design (open, sealed or shielded), with proven performance in many industrial fields. Having optimized internal geometry, they can operate at high speeds, sustaining radial and axial loads in both directions and generating low friction.

RKB DGGBs are engineered to successfully respond to the most demanding application requirements, in terms of high speeds, heavy loads and low noise. This is mainly due to the use of the best raw materials and manufacturing technology, that permit to deliver only premium deep groove ball bearings.

Bearings with contact seals

Seals are retained in their correct position by a recess in the outer ring. They are normally made by acrylonitrile-butadiene rubber (NRB) with a metallic reinforcement, so the continuous range working temperature is from -40 to 100 °C. A peak temperature of 120 °C can be supported for a short period of time. If the sealed bearings have to be used in harsh conditions, e.g. high temperature or high rotation speed, a grease leakage from the inner ring side could take place. In these cases a special seals design could be requested, so please consult the RKB application engineering service.

Internal clearance

Single row deep groove ball bearings are produced as standard with Normal radial clearance CN, but they can be manufactured featuring C2 ,C3, C4 and C5 radial clearance, in accordance with the ISO 5753:2009.

Bearings with special radial clearance in a different range than ISO 5753:2009 can be manufactured on request.

The radial clearance values are provided in the **Tab. 1 page 13** and they are valid only for bearing not yet mounted and loaded.

Misalignment

For single row deep groove ball bearing is not possible to determine a unique value of the shaft and housing misalignment.

Permissible misalignment depends on several factors such as:

- Radial internal clearance;
- Bearing size;
- Internal design;
- Forces and moments acting on it.

According to the above concept and depending on the influences of all these variables, the corresponding permissible misalignment vary between 2 and 10 minutes of arc, but it has to be considered that the induced additional stress inside the bearing influences negatively its service life.

For additional information, please consult the RKB application engineering service.

Minimum load

A minimum radial load is requested for single row deep groove ball bearing to allow an adequate operating condition, especially in presence of difficult working conditions like: high speed, high acceleration and sudden changes of rotating direction. According to these operating conditions, a skidding between balls and raceways can be generated by the inertial forces, influencing negatively the bearing life. Minimum radial load help to prevent such problem and can be theoretically estimated using the following formula:

$$\frac{F_{rm}}{C_r} > 0,015$$

where:

- F_{rm} minimum radial load, [kN];
- C_r basic dynamic load rating, [kN].

Usually, the minimum radial load is reached or surpassed by the weight of the components supported by the bearing together with the loads acting on it, otherwise supplementary radial load must be applied on the single row

deep groove ball bearing. In application where a starting up at a low temperature is planned or a lubricant with high viscosity is used, a larger minimum radial load is required.

It is possible to apply the axial preload for single row deep groove ball bearing by adjusting one ring against the other one or by using springs.

Axial load carrying capacity

If the single row deep groove ball bearings are subjected to the axial load, its value should not exceed:

- $0.25 C_0$ for small bearing (bore up to 12 mm) and light series bearing (diameter series 8, 9, 0 and 1);
- $0.5 C_0$ for the other series.

It has to be considered that an excessive axial load will influenced negatively the bearing life.

Deep groove ball bearings

d [mm]		Radial internal clearance [μm]									
		C2		CN		C3		C4		C5	
over	incl.	min.	max.	min.	max.	min.	max.	min.	max.	min.	max.
2.5	6	0	7	2	13	8	23	–	–	–	–
6	10	0	7	2	13	8	23	14	29	20	37
10	18	0	9	3	18	11	25	18	33	25	45
18	24	0	10	5	20	13	28	20	36	28	48
24	30	1	11	5	20	13	28	23	41	30	53
30	40	1	11	6	20	15	33	28	46	40	64
40	50	1	11	6	23	18	36	30	51	45	73
50	65	1	15	8	28	23	43	38	61	55	90
65	80	1	15	10	30	25	51	46	71	65	105
80	100	1	18	12	36	30	58	53	84	75	120
100	120	2	20	15	41	36	66	61	97	90	140
120	140	2	23	18	48	41	81	71	114	105	160
140	160	2	23	18	53	46	91	81	130	120	180
160	180	2	25	20	61	53	102	91	147	135	200
180	200	2	30	25	71	63	117	107	163	150	230
200	225	2	35	25	85	75	140	125	195	175	265
225	250	2	40	30	95	85	160	145	225	205	300
250	280	2	45	35	105	90	170	155	245	225	340
280	315	2	55	40	115	100	190	175	270	245	370
315	355	3	60	45	125	110	210	195	300	275	410
355	400	3	70	55	145	130	240	225	340	315	460
400	450	3	80	60	170	150	270	250	380	350	520
450	500	3	90	70	190	170	300	280	420	390	570
500	560	10	100	80	210	190	330	310	470	440	630
560	630	10	110	90	230	210	360	340	520	490	700
630	710	20	130	110	260	240	400	380	570	540	780
710	800	20	140	120	290	270	450	430	630	600	860
800	900	20	160	140	320	300	500	480	700	670	960
900	1 000	20	170	150	350	330	550	530	770	740	1 040
1 000	1 120	20	180	160	380	360	600	580	850	820	1 150
1 120	1 250	20	190	170	410	390	650	630	920	890	1 260
1 250	1 400	30	200	190	440	420	700	680	1 000	–	–
1 400	1 600	30	210	210	470	450	750	730	1 060	–	–

Tab. 1 - Radial internal clearance of deep groove ball bearings

Designs and variants

Type J

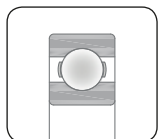

- One-piece inner and outer ring
- High strength two-piece pressed steel cage guided on balls (J)
- Execution suitable for high operating speeds
- Available with snap ring groove in outer ring for axial location (N)

Type TN

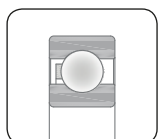

- One-piece inner and outer ring
- High strength two-piece pressed steel cage guided on balls (J)
- Two non-contacting steel shields at both sides (ZZ)
- Supplied already filled with grease for maintenance free operations
- Shielded type to keep the grease inside the bearing without compromising the limiting speed

Type M

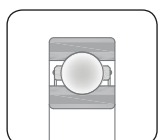

- One-piece inner and outer ring
- Two-piece machined brass cage guided on

balls (M)

- Execution suitable for very high operating speeds
- Available with two-piece machined brass cage guided on inner ring (MB) or outer ring (MA)
- Available with axial lubrication grooves in the guiding surface of the cage (MAS/MBS)
- Available with locating slot in outer ring for axial location (N1)

Seal type ZZ

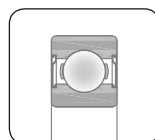

- One-piece inner and outer ring
- Moulded glass fiber reinforced polyamide snap-in cage guided on balls (TN)
- Execution suitable for very high accelerations and operating speeds

Seal type 2RS

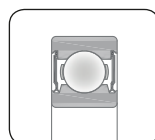

- One-piece inner and outer ring
- High strength two-piece pressed steel cage guided on balls (J)
- Two contacting rubber seals at both sides (2RS)
- Supplied already filled with grease for maintenance free operations
- Sealed type to keep the grease inside the bearing and enhance contaminant exclusion

Deep groove ball bearings

Prefixes

F	Flanged outer ring
DGGB	Out of standard deep groove ball bearing followed by drawing number

Suffixes

Internal design

HAS	Special execution for high-speed wire guide blocks
-----	--

Suffixes

Cage

J	Pressed steel cage
M	Machined brass cage guided on rolling elements
MA	Machined brass cage guided on outer ring
MAS	Machined brass cage guided on outer ring with lubrication grooves in the guiding surface
MB	Machined brass cage guided on inner ring
MBS	Machined brass cage guided on inner ring with lubrication grooves in the guiding surface
TN or ATN	Molded polyamide cage (PA66) guided on rolling elements
TN9	Molded glass fiber-reinforced polyamide cage (PA66-GF25) guided on rolling elements

Suffixes

Accuracy, clearance, running

ABEC1	Approximated to tolerance class P0
ABEC3	Approximated to tolerance class P6
ABEC5	Approximated to tolerance class P5
ST	Special tolerance
CM	Special radial internal clearance for EMQ applications

Radial internal clearance of extra small and miniature ball bearings

Units: μm

MC1...MC6	Clearance symbol		MC1		MC2		MC3		MC4		MC5		MC6	
	min.	max.	min.	max.	min.	max.	min.	max.	min.	max.	min.	max.	min.	max.
Clearance	0	5	3	8	5	10	8	13	13	20	20	20	28	28

- Remarks**
1. The standard clearance is MC3.
 2. To obtain the measured value, add the correction amount in the table below

CS	Special radial internal clearance
EMQ	Electric motor quality: bearing specifically designed for quiet running in electric motors
S12	Special selection for extremely low noise running
P66	Vibration peaks and noise level lower than normal

Suffixes	External design
Z	Shield on one side
ZZ or 2Z	Shield on both sides
RS	Contact seal on one side
2RS	Contact seal on both sides
RSL	Light contact seal on one side
2RSL	Light contact seal on both sides
G/R3	Filled with exceptionally good low noise and long life grease usable over a wide range of temperatures
G/R4	Filled with good low noise and high temperature, high speed and long life grease
N	Snap ring groove in outer ring
NR	Snap ring groove in outer ring with suitable snap ring
N1	One locating slot in outer ring
N2	Two locating slots in outer ring

Deep groove ball bearings

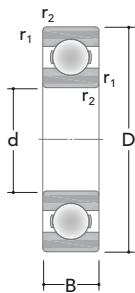

J

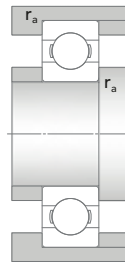

Main dimensions			Basic load ratings		Speed ratings		Dimensions		Mass	Designation
d	D	B	Dynamic C	Static C ₀	Reference	Limiting	r _{1,2min}	r _{a,max}		
[mm]			[kN]		[rpm]		[mm]		[kg]	-
3	10	4	0,55	0,19	124000	65600	0,15	0,1	0,0015	623
4	9	2,5	0,46	0,13	134000	70800	0,1	0,1	0,0007	618/4
	11	4	0,71	0,20	127000	68700	0,15	0,1	0,0017	619/4
	12	4	0,94	0,32	116000	63600	0,2	0,2	0,0021	604
	13	5	1,04	0,31	107000	56500	0,2	0,2	0,0031	624
	16	5	1,24	0,43	92600	51900	0,3	0,3	0,0054	634
5	11	3	0,51	0,16	115000	61900	0,15	0,1	0,0012	618/5
	13	4	1,00	0,37	107000	60700	0,2	0,2	0,0025	619/5
	16	5	1,11	0,37	92400	50500	0,3	0,3	0,005	625
	19	6	2,28	0,93	77900	43100	0,3	0,3	0,0085	635
6	13	3,5	0,77	0,25	106000	56800	0,15	0,1	0,002	618/6
	15	5	0,98	0,31	97600	54600	0,2	0,2	0,0039	619/6
	19	6	2,27	0,94	77600	42000	0,3	0,3	0,0081	626
7	14	3,5	0,88	0,30	96700	54000	0,15	0,1	0,0022	618/7
	17	5	1,16	0,41	86900	46200	0,3	0,3	0,0049	619/7
	19	6	2,27	0,95	82300	44900	0,3	0,3	0,0076	607
	22	7	3,36	1,35	68000	37400	0,3	0,3	0,012	627
8	16	4	0,84	0,32	88100	46400	0,2	0,2	0,003	618/8
	19	6	1,51	0,50	82200	45900	0,3	0,3	0,0071	619/8
	22	7	3,35	1,36	72800	40300	0,3	0,3	0,012	608
	24	8	3,81	1,65	61400	33400	0,3	0,3	0,018	628
9	17	4	0,89	0,36	82800	43600	0,2	0,2	0,0034	618/9
	20	6	2,43	1,01	76900	43000	0,3	0,3	0,0076	619/9
	24	7	3,75	1,65	67300	36200	0,3	0,3	0,014	609
	26	8	4,59	1,95	57900	31700	0,3	0,3	0,02	629
10	19	5	1,75	0,86	76800	41300	0,3	0,3	0,0053	61800
	22	6	2,81	1,30	67400	37500	0,3	0,3	0,01	61900
	26	8	4,58	1,93	64500	33300	0,3	0,3	0,019	6000
	28	8	5,26	2,53	58200	31500	0,3	0,3	0,024	16100
	30	9	5,28	2,35	54700	30800	0,6	0,6	0,031	6200
	35	11	8,22	3,38	48200	27600	0,6	0,6	0,053	6300
12	21	5	1,83	0,96	68100	36200	0,3	0,3	0,0063	61801
	24	6	3,07	1,56	65300	34200	0,3	0,3	0,011	61901

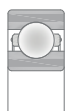

M

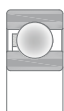

TN

Main dimensions			Basic load ratings		Speed ratings		Dimensions		Mass	Designation
d	D	B	Dynamic C	Static C ₀	Reference	Limiting	r _{1,2min}	r _{amax}		
[mm]			[kN]		[rpm]		[mm]		[kg]	–
12	28	8	5,28	2,36	58700	31400	0,3	0,3	0,021	6001
	30	8	5,07	2,46	58200	32300	0,3	0,3	0,026	16101
	32	10	7,07	3,04	48500	27200	0,6	0,6	0,037	6201
	37	12	9,81	4,11	43600	23500	1	1	0,06	6301
15	24	5	1,90	1,13	57900	32800	0,3	0,3	0,0065	61802
	28	7	4,46	2,30	54000	29000	0,3	0,3	0,016	61902
	32	8	5,71	2,81	48800	26400	0,3	0,3	0,03	16002
	32	9	5,66	2,82	48400	26800	0,3	0,3	0,03	6002
	35	11	7,80	3,71	41600	23700	0,6	0,6	0,045	6202
	42	13	11,6	5,39	37100	20500	1	1	0,082	6302
17	26	5	2,04	1,35	54000	28300	0,3	0,3	0,0075	61803
	30	7	4,81	2,68	48100	26600	0,3	0,3	0,016	61903
	35	8	6,23	3,24	44000	23400	0,3	0,3	0,038	16003
	35	10	6,21	3,23	43800	23300	0,3	0,3	0,038	6003
	40	12	9,71	4,73	37000	19800	0,6	0,6	0,065	6203
	47	14	13,9	6,49	32900	18400	1	1	0,11	6303
	62	17	24,0	11,1	27100	15300	1,1	1	0,27	6403
20	32	7	4,10	2,36	44000	23400	0,3	0,3	0,018	61804
	37	9	6,66	3,83	41600	21700	0,3	0,3	0,037	61904
	42	8	7,07	3,98	36900	20400	0,3	0,3	0,05	16004
	42	12	9,67	4,96	36900	20200	0,6	0,6	0,067	6004
	47	14	13,1	6,44	31100	17200	1	1	0,11	6204
	52	15	16,2	7,66	28800	16000	1,1	1	0,14	6304
	72	19	31,9	16,0	23200	12700	1,1	1	0,41	6404
22	50	14	14,0	8,02	29000	16500	1	1	0,13	62/22
	56	16	19,2	9,62	27300	15500	1,1	1	0,18	63/22
25	37	7	4,48	2,79	36800	20600	0,3	0,3	0,022	61805
	42	9	7,31	4,62	34700	18700	0,3	0,3	0,045	61905
	47	8	7,89	4,70	31300	17300	0,3	0,3	0,06	16005
	47	12	11,5	6,44	30800	16600	0,6	0,6	0,078	6005
	52	15	14,3	7,70	27000	14800	1	1	0,13	6205
	62	17	22,5	11,4	23100	13600	1,1	1	0,23	6305
	80	21	35,8	19,9	19200	11100	1,5	1,5	0,54	6405
28	58	16	17,3	10,20	25000	13300	1	1	0,17	62/28
	68	18	25,8	14,0	21500	11600	1,1	1	0,3	63/28

Deep groove ball bearings

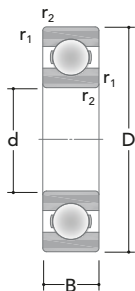

J

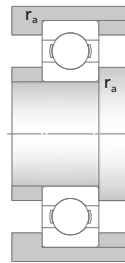

Main dimensions			Basic load ratings		Speed ratings		Dimensions		Mass	Designation
d	D	B	Dynamic C ₀	Static C ₀	Reference	Limiting	r _{1,2min}	r _a max		
[mm]			[kN]		[rpm]		[mm]		[kg]	-
30	42	7	4,61	2,98	31200	17300	0,3	0,3	0,025	61806
	47	9	7,62	4,72	29300	15900	0,3	0,3	0,049	61906
	55	9	11,6	7,22	27200	14600	0,3	0,3	0,089	16006
	55	13	13,3	8,27	27000	14500	1	1	0,12	6006
	62	16	19,5	11,0	23000	12900	1	1	0,2	6206
	72	19	28,6	15,8	19200	10800	1,1	1	0,35	6306
	90	23	44,5	24,3	17400	9250	1,5	1,5	0,75	6406
35	47	7	4,59	3,43	29200	15000	0,3	0,3	0,029	61807
	55	10	11,3	8,30	25100	13700	0,6	0,6	0,08	61907
	62	9	12,7	8,02	23300	12900	0,3	0,3	0,11	16007
	62	14	16,3	10,2	23200	12400	1	1	0,15	6007
	72	17	26,1	15,1	19300	10800	1,1	1	0,29	6207
	80	21	33,7	18,6	18200	10200	1,5	1,5	0,46	6307
	100	25	54,9	32,6	15400	8600	1,5	1,5	0,97	6407
40	52	7	4,65	3,96	25400	13500	0,3	0,3	0,032	61808
	62	12	14,0	10,30	23400	11900	0,6	0,6	0,12	61908
	68	9	13,5	10,1	21500	11500	0,3	0,3	0,13	16008
	68	15	17,4	10,8	21400	11700	1	1	0,19	6008
	80	18	31,4	18,9	17300	9500	1,1	1	0,37	6208
	90	23	41,1	23,8	16500	9000	1,5	1,5	0,63	6308
	110	27	65,8	37,8	13600	7700	2	2	1,25	6408
45	58	7	6,92	6,26	21200	11800	0,3	0,3	0,04	61809
	68	12	14,1	11,0	19400	11100	0,6	0,6	0,14	61909
	75	10	16,1	10,6	19400	10100	0,6	0,6	0,17	16009
	75	16	21,5	14,5	19400	9800	1	1	0,24	6009
	85	19	34,2	21,3	16500	9400	1,1	1	0,42	6209
	100	25	53,8	31,3	14600	8000	1,5	1,5	0,84	6309
	120	29	78,6	48,0	12500	7100	2	2	1,55	6409
50	65	7	7,07	7,00	19300	11100	0,3	0,3	0,052	61810
	72	12	14,8	12,2	18200	10200	0,6	0,6	0,14	61910
	80	10	16,3	11,3	17400	9400	0,6	0,6	0,18	16010
	80	16	22,4	15,8	17600	9500	1	1	0,26	6010
	90	20	36,0	22,7	14500	8600	1,1	1	0,45	6210
	110	27	63,4	37,8	12600	7200	2	2	1,1	6310
	130	31	90,9	53,9	11600	6500	2,1	2	1,95	6410
55	72	9	9,48	9,32	18600	10300	0,3	0,3	0,083	61811

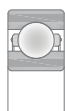

M

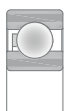

TN

Main dimensions			Basic load ratings		Speed ratings		Dimensions		Mass	Designation
d	D	B	Dynamic C	Static C ₀	Reference	Limiting	r _{1,2min}	r _{amax}		
[mm]			[kN]		[rpm]		[mm]		[kg]	–
55	80	13	16,6	15,1	16600	9200	1	1	0,19	61911
	90	11	19,7	13,9	15500	8600	0,6	0,6	0,27	16011
	90	18	28,7	20,9	15400	8500	1,1	1	0,39	6011
	100	21	45,0	28,5	13600	7700	1,5	1,5	0,61	6211
	120	29	71,3	44,6	11500	6600	2	2	1,35	6311
	140	33	101,7	64,7	10600	5800	2,1	2	2,35	6411
60	78	10	12,3	11,6	16300	9000	0,3	0,3	0,11	61812
	85	13	16,6	15,2	15600	8400	1	1	0,2	61912
	95	11	20,4	15,0	14600	8200	0,6	0,6	0,29	16012
	95	18	29,8	23,0	14500	8200	1,1	1	0,41	6012
	110	22	53,7	35,7	12600	6600	1,5	1,5	0,78	6212
	130	31	82,9	51,6	10600	5800	2,1	2	1,7	6312
150	35	113	72,2	9700	5200	2,1	2	2,85	6412	
65	85	10	12,8	13,3	15400	8500	0,6	0,6	0,13	61813
	90	13	17,5	16,4	14400	8000	1	1	0,22	61913
	100	11	22,0	19,4	13700	7500	0,6	0,6	0,3	16013
	100	18	31,2	24,7	13600	7400	1,1	1	0,44	6013
	120	23	57,3	40,0	11700	6300	1,5	1,5	1	6213
	140	33	94,9	59,0	9700	5700	2,1	2	2,1	6313
	160	37	120	83,5	9200	4900	2,1	2	3,35	6413
70	90	10	12,8	13,7	14400	7600	0,6	0,6	0,14	61814
	100	16	24,9	21,8	13700	7300	1	1	0,35	61914
	110	13	28,4	24,6	12600	6700	0,6	0,6	0,44	16014
	110	20	38,6	30,8	12600	6700	1,1	1	0,61	6014
	125	24	61,9	44,2	10600	6000	1,5	1,5	1,1	6214
	150	35	108	66,7	9200	5300	2,1	2	2,55	6314
	180	42	151	109	8300	4500	3	2,5	4,95	6414
75	95	10	13,1	15,1	13400	7300	0,6	0,6	0,15	61815
	105	16	24,4	23,1	12600	6500	1	1	0,37	61915
	115	13	29,3	27,0	11600	6300	0,6	0,6	0,46	16015
	115	20	40,1	33,3	11500	6400	1,1	1	0,65	6015
	130	25	67,3	48,3	9700	5700	1,5	1,5	1,2	6215
	160	37	116	75,1	8700	4700	2,1	2	3,05	6315
190	45	159	117	7700	4100	3	2,5	5,8	6415	
80	100	10	13,4	15,8	12500	6600	0,6	0,6	0,15	61816
	110	16	26,5	21,7	11600	6200	1	1	0,38	61916

Deep groove ball bearings

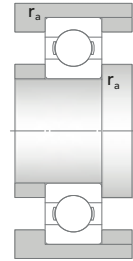
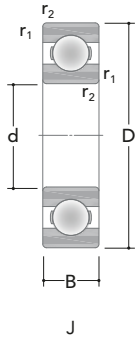

J

Main dimensions			Basic load ratings		Speed ratings		Dimensions		Mass	Designation
d	D	B	Dynamic	Static	Reference	Limiting	$r_{1,2min}$	r_{amax}		
[mm]			[kN]	C_0	[rpm]		[mm]		[kg]	-
80	125	14	34,1	31,3	10700	6000	0,6	0,6	0,61	16016
	125	22	48,3	39,9	10700	6000	1,1	1	0,87	6016
	140	26	71,1	54,8	9200	5100	2	2	1,45	6216
	170	39	125	85,0	8100	4500	2,1	2	3,65	6316
	200	48	171	133	7200	4000	3	2,5	6,85	6416
85	110	13	19,8	21,0	11600	6300	1	1	0,27	61817
	120	18	32,1	30,9	10700	5900	1,1	1	0,55	61917
	130	14	34,9	33,0	10700	5700	0,6	0,6	0,64	16017
	130	22	50,8	42,5	10700	5700	1,1	1	0,92	6017
	150	28	85,1	63,8	8700	4800	2	2	1,8	6217
	180	41	135	95,1	7700	4200	3	2,5	4,25	6317
	210	52	173	143	6700	3800	4	3	8,05	6417
90	115	13	19,7	23,1	10600	5900	1	1	0,28	61818
	125	18	34,2	33,8	10600	5500	1,1	1	0,59	61918
	140	16	42,5	38,5	9700	5400	1	1	0,85	16018
	140	24	59,1	49,8	9700	5300	1,5	1,5	1,15	6018
	160	30	97,0	72,8	8100	4400	2	2	2,2	6218
	190	43	147	107	7200	4000	3	2,5	4,95	6318
	225	54	190	153	6400	3500	4	3	9,8	6418
95	120	13	20,3	24,2	10600	5500	1	1	0,3	61819
	130	18	34,9	34,3	9700	5200	1,1	1	0,61	61919
	145	16	43,1	41,1	9100	4900	1	1	0,89	16019
	145	24	62,2	53,8	9200	5200	1,5	1,5	1,1	6019
	170	32	110	80,7	7600	4100	2,1	2	2,65	6219
	200	45	153	117	6700	3800	3	2,5	5,75	6319
100	125	13	17,9	19,2	9700	5300	1	1	0,31	61820
	140	20	42,6	44,0	9100	4900	1,1	1	0,83	61920
	150	16	45,1	43,4	9200	4700	1	1	0,94	16020
	150	24	61,3	53,0	9100	4600	1,5	1,5	1,25	6020
	180	34	123	92,7	7200	4100	2,1	2	3,15	6220
	215	47	180	145	6500	3500	3	2,5	7,1	6320
105	130	13	21,9	20,3	9700	5400	1	1	0,32	61821
	145	20	45,6	45,0	9200	4700	1,1	1	0,87	61921
	160	18	52,0	50,6	8100	4500	1	1	1,2	16021
	160	26	73,6	64,6	8200	4300	2	2	1,6	6021
	190	36	134	103	6700	3600	2,1	2	3,8	6221

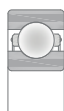

M

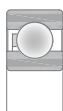

TN

Main dimensions			Basic load ratings		Speed ratings		Dimensions		Mass	Designation
d	D	B	Dynamic C	Static C ₀	Reference	Limiting	r _{1,2min}	r _{amax}		
[mm]			[kN]		[rpm]		[mm]		[kg]	–
105	225	49	185	162	6100	3400	3	2,5	8,15	6321
110	140	16	29,2	27,0	9200	4600	1	1	0,49	61822
	150	20	44,6	46,5	8700	4700	1,1	1	0,9	61922
	170	19	59,2	56,4	7800	4100	1	1	1,45	16022
	170	28	83,1	72,4	7800	4200	2	2	1,95	6022
	200	38	146	117	6400	3600	2,1	2	4,45	6222
	240	50	209	189	5700	3100	3	2,5	9,65	6322
120	150	16	29,3	28,8	8200	4500	1	1	0,54	61824
	165	22	54,9	58,9	7700	4300	1,1	1	1,2	61924
	180	19	61,6	63,2	7200	4100	1	1	1,55	16024
	180	28	86,5	79,1	7300	4100	2	2	2,1	6024
	215	40	152	122	6100	3300	2,1	2	5,25	6224
	260	55	215	200	5400	2900	3	2,5	12,5	6324
130	165	18	38,5	46,1	7700	4000	1,1	1	0,77	61826
	180	24	67,8	71,3	7300	3700	1,5	1,5	1,6	61926
	200	22	80,6	81,4	6700	3500	1,1	1	2,35	16026
	200	33	110	100	6800	3600	2	2	3,25	6026
	230	40	159	137	5300	3100	3	2,5	5,85	6226
	280	58	235	223	4800	2800	4	3	17,5	6326
140	175	18	40,8	49,2	7300	3700	1,1	1	0,85	61828
	190	24	67,5	74,2	6700	4600	1,5	1,5	2	61928
	210	22	85,2	89,8	6500	3300	1,1	1	2,55	16028
	210	33	114	110	6400	3200	2	2	3,45	6028
	250	42	167	152	5100	2700	3	2,5	7,75	6228
	300	62	259	258	4600	3600	4	3	21,5	6328
150	190	20	50,8	63,0	6500	3600	1,1	1	1,2	61830
	210	28	91,2	97,8	6100	4400	2	2	3,05	61930
	225	24	95,3	101,4	5800	3200	1,1	1	3,15	16030
	225	35	128	132	5800	3200	2,1	2	4,3	6030
	230	35	131	128	2500	2600	2,1	2	5,3	306891
	270	45	179	169	4800	2600	3	2,5	10	6230
	320	65	284	294	4100	3300	4	3	26	6330
160	200	20	51,3	68,4	6100	3400	1,1	1	1,25	61832
	220	28	95,3	102,4	5700	4100	2	2	3,2	61932
	240	25	104,0	110	5400	3000	1,5	1,5	3,65	16032

Deep groove ball bearings

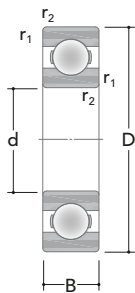

J

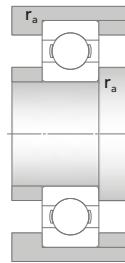

Main dimensions			Basic load ratings		Speed ratings		Dimensions		Mass	Designation
d	D	B	Dynamic C	Static C ₀	Reference	Limiting	r _{1,2min}	r _{amax}		
[mm]			[kN]		[rpm]		[mm]		[kg]	-
160	240	38	150	149	5400	3000	2,1	2	5,2	6032
	290	48	192	190	4300	2400	3	2,5	13	6232
	340	68	292	293	3900	3100	4	3	30,5	6332
170	215	22	61,3	82,8	5700	3000	1,1	1	1,65	61834
	230	28	95,3	112	5300	4100	2	2	3,4	61934
	260	28	119	131	5100	2600	1,5	1,5	5	16034
	260	42	170	179	5100	3600	2,1	2	8,15	6034
	310	52	220	236	4100	3100	4	3	18	6234
	360	72	315	354	3600	2700	4	3	36	6334
180	225	22	65,8	83,6	5400	2800	1,1	1	1,75	61836
	250	33	120	139	5100	3700	2	2	5	61936
	259,5	33	145	153	2100	2400	2,7	2,5	5,95	306840
	280	31	141	151	4600	3500	2	2	6,5	16036
	280	46	189	215	4600	3400	2,1	2	10,5	6036
	320	52	241	244	3900	3100	4	3	18,5	6236
	380	75	356	419	3400	2700	4	3	42	6336
	190	240	24	80,6	102,9	5100	2700	1,5	1,5	2,25
260		33	121	142	4800	3500	2	2	5,2	61938
269,5		33	119	141	2100	2300	2	2	6,25	306627
290		31	156	175	4600	2400	2	2	6,9	16038
290		46	204	222	4600	3200	2,1	2	11	6038
340		55	262	293	3600	2800	4	3	22	6238
400		78	378	452	3200	2500	5	4	48,5	6338
190,5		290	46	197	222	1900	2200	2	2	11
200	250	24	79,5	109	4800	2700	1,5	1,5	2,35	61840
	250	24	60,9	87,2	1800	2000	1,9	1,5	2,65	306870
	279,5	38	152	172	1900	2100	2,1	2	7,25	360278
	280	38	149	177	4600	3200	2,1	2	7,3	61940
	289,5	38	162	190	1800	2000	2,1	2	8,7	306841
	310	34	169	202	4100	2400	2	2	8,8	16040
	310	51	217	261	4100	3100	2,1	2	14,5	6040
	360	58	271	321	3400	2600	4	3	26,5	6240
	420	80	385	485	3000	2300	5	4	55,5	6340
220	270	24	82	118	4300	2300	1,5	1,5	2,55	61844
	300	38	156	192	4100	3000	2,1	2	7,95	61944

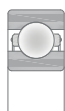

M

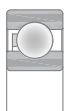

TN

Main dimensions			Basic load ratings		Speed ratings		Dimensions		Mass	Designation	
d	D	B	Dynamic C	Static C ₀	Reference	Limiting	r _{1,2min}	r _{amax}			
[mm]			[kN]		[rpm]		[mm]		[kg]	–	
220	300	25	83	126	1800	2000	1,5	1,5	5	60944	
	309,5	38	159	190	1800	1900	2,1	2	9,25	306867	
	340	37	178	211	3900	2000	2,1	2	11,5	16044	
	340	56	257	303	3800	2600	3	2,5	19	6044	
	400	65	296	384	3000	2400	4	3	37	6244	
	460	88	415	527	2700	2100	5	4	72,5	6344	
230	329,5	40	193	243	1700	1800	2,1	2	12	306842	
240	300	28	110	160	3900	2200	2	2	3,9	61848	
	320	38	158	206	3800	2700	2,1	2	8,55	61948	
	360	37	206	264	3500	2500	2,1	2	14	16048	
	360	56	257	324	3400	2400	3	2,5	20,5	6048	
	440	72	372	500	2900	2100	4	3	51	6248	
	500	95	445	601	2500	1900	5	4	92,5	6348	
247	360	37	185	222	1600	1700	2,1	2	14	16048/247	
260	320	28	112	173	3600	2000	2	2	4,15	61852	
	360	46	217	288	3400	2500	2,1	2	14,5	61952	
	369,5	46	217	290	1500	1500	2,1	2	16,5	306862	
	400	44	251	325	3100	2400	3	2,5	22,5	16052	
	400	65	305	389	3100	2400	4	3	30	6052	
	480	80	393	561	2200	2000	5	4	65,5	6252	
	540	102	521	745	2300	1800	6	5	115	6352	
	280	350	33	143	208	3200	1800	2	2	6,25	61856
280	380	46	214	302	3000	2300	2,1	2	15,5	61956	
	389,5	46	218	296	1400	1500	2,1	2	18	306861	
	420	44	253	358	2900	2100	3	2,5	24	16056	
	420	65	309	430	2900	2100	4	3	31,5	6056	
	500	80	439	635	2500	1700	5	4	71	6256	
	580	108	592	880	2200	1700	6	5	140	6356	
	300	380	38	176	258	3100	2200	2,1	2	10,5	61860
	300	420	56	275	386	2900	2000	3	2,5	24,5	61960
460		50	285	416	2700	2000	4	3	32	16060	
460		74	364	514	2700	2000	4	3	44	6060	
540		85	470	708	2300	1700	5	4	88,5	6260	
320		400	38	173	272	2900	2000	2,1	2	11	61864

Deep groove ball bearings

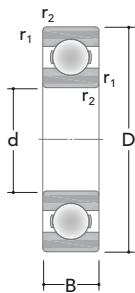

J

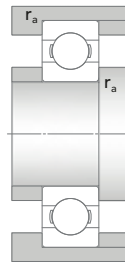

Main dimensions			Basic load ratings		Speed ratings		Dimensions		Mass	Designation
d	D	B	Dynamic C	Static C ₀	Reference	Limiting	r _{1,2min}	r _{a,max}		
[mm]			[kN]		[rpm]		[mm]		[kg]	–
320	440	37	218	325	1100	1200	2,1	2	16	60964
	440	56	277	430	2700	2000	3	2,5	25,5	61964
	480	50	291	416	2500	1800	4	3	34	16064
	480	74	376	564	2500	1800	4	3	46	6064
	580	92	535	829	2000	1500	5	4	110	6264
330	460	56	291	449	1000	1100	3	2,5	30	306728
340	420	38	183	286	2600	2000	2,1	2	11,5	61868
	460	56	281	439	2400	1800	3	2,5	26,5	61968
	480	60	305	451	1000	1100	4	3	36	306890
	520	57	353	549	2300	1700	4	3	45	16068
	520	82	437	649	2300	1600	5	4	62	6068
620	92	585	961	1800	1300	6	5	110	6268	
350	500	70	320	500	970	1000	4	3	46	306674
360	440	38	182	294	2500	1800	2,1	2	12	61872
	440	25	126	226	1000	1100	1,5	1,5	6,5	60872
	480	56	308	476	2500	1600	3	2,5	28	61972
	540	57	368	593	2300	1500	4	3	49	16072
	540	82	445	735	2300	1500	5	4	64,5	6072
380	480	46	244	413	2300	1600	2,1	2	20	61876
	520	65	340	555	2300	1600	4	3	40	61976
	550	82	414	720	910	1000	5	4	65	306682
	560	57	383	637	2100	1400	4	3	51	16076
	560	82	446	726	2100	1500	5	4	70,5	6076
400	500	46	249	413	2300	1600	2,1	2	20,5	61880
	500	31	170	297	960	1100	2	2	15,5	60880
	540	65	360	601	2100	1500	4	3	41,5	61980
	540	44	263	471	910	1000	3	2,5	27,5	60980
	590	74	450	762	860	900	4	3	70	306614
	600	90	542	911	1900	1400	5	4	87,5	6080
420	520	46	253	433	2100	1500	2,1	2	21,5	61884
	560	65	368	607	2100	1400	4	3	43	61984
	620	90	535	920	1900	1300	5	4	91,5	6084
440	540	46	260	453	2100	1500	2,1	2	22,5	61888

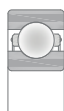

M

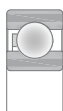

TN

Main dimensions			Basic load ratings		Speed ratings		Dimensions		Mass	Designation
d	D	B	Dynamic C	Static C ₀	Reference	Limiting	r _{1,2min}	r _{amax}		
[mm]			[kN]		[rpm]		[mm]		[kg]	–
440	540	31	158	304	870	950	2	2	16,5	60888
	600	74	413	747	1900	1300	4	3	60,5	61988
	600	50	328	590	870	940	4	3	40	60988
	650	94	585	1031	1800	1200	6	5	105	6088
460	580	56	337	597	1900	1300	3	2,5	35	61892
	620	74	432	759	1800	1300	4	3	62,5	61992
	680	100	595	1113	1700	1200	6	5	120	6092B
480	600	56	336	616	1800	1300	3	2,5	36,5	61896
	650	78	470	864	1700	1200	5	4	74	61996
	700	100	624	1210	1600	1100	6	5	125	6096
487,5	650	78	445	855	770	810	5	4	65	614885
500	620	56	331	661	1700	1200	3	2,5	40,5	618/500
	620	37	231	462	770	790	2,1	2	20	608/500
500	670	78	478	881	1600	1100	5	4	77	619/500
	720	100	633	1198	1500	1100	6	5	135	60/500
530	650	56	347	672	1600	1100	3	2,5	39,5	618/530
	710	82	500	963	1500	1000	5	4	90,5	619/530
	710	57	448	872	680	700	4	3	61	609/530
	760	100	601	1177	610	650	6	5	150	360476
	780	112	660	1313	1400	910	6	5	185	60/530
560	680	56	344	722	1500	1000	3	2,5	42	618/560
	680	37	230	482	680	720	2,1	2	30,5	608/560
	750	85	508	1019	1400	1000	5	4	105	619/560
	820	115	666	1469	1300	1000	6	5	210	60/560
600	730	60	368	774	1400	990	3	2,5	52	618/600
	730	42	276	563	640	670	3	2,5	40	608/600
	800	90	610	1246	1300	950	5	4	125	619/600
	870	118	754	1569	580	600	6	5	230	60/600B
630	780	69	444	1026	1300	950	4	3	73	618/630
	780	48	373	785	600	640	3	2,5	41	608/630
	850	100	640	1399	1200	940	6	5	160	619/630
	850	71	500	1102	580	600	5	4	110	609/630

Deep groove ball bearings

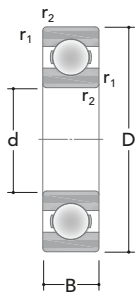

J

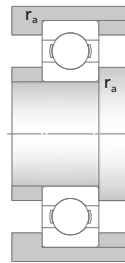

Main dimensions			Basic load ratings		Speed ratings		Dimensions		Mass	Designation
d	D	B	Dynamic C	Static C ₀	Reference	Limiting	r _{1,2min}	r _{amax}		
[mm]			[kN]		[rpm]		[mm]		[kg]	-
630	920	128	822	1810	1100	860	7,5	6	285	60/630
650	920	118	794	1789	510	520	6	5	250	306708
670	820	69	449	1029	1200	910	4	3	83,5	618/670
	900	103	688	1539	1100	820	6	5	185	619/670
	900	73	573	1307	540	560	5	4	145	609/670
	980	136	912	2140	1000	770	7,5	6	345	60/670
710	870	74	475	1113	1100	840	4	3	93,5	618/710
	950	106	701	1594	1000	780	6	5	220	619/710
	950	78	570	1357	480	510	5	4	150	609/710
	1000	140	856	1972	460	480	7,5	6	335	306704
	1030	140	990	2344	960	720	7,5	6	375	60/710
	1080	160	1040	2460	410	430	7,5	6	505	360141
730	940	100	671	1535	480	510	6	5	175	361840
750	920	78	542	1257	1000	740	5	4	110	618/750
	1000	112	771	1844	960	700	6	5	255	619/750
	1090	150	1033	2516	430	440	7,5	6	485	60/750
760	1080	150	967	2257	430	430	7,5	6	430	306474
800	980	82	560	1428	970	690	5	4	130	618/800
	980	57	418	1049	430	450	4	3	100	608/800
	1060	115	851	2120	910	660	6	5	275	619/800
	1080	115	828	2121	410	430	6	5	320	361844
	1150	155	1030	2700	860	620	7,5	6	535	60/800
850	1030	82	580	1477	920	640	5	4	140	618/850
	1030	57	396	1081	410	410	4	3	75	608/850
	1120	118	838	2258	820	640	6	5	310	619/850
	1220	165	1080	2900	350	360	7,5	6	630	306493
	1220	165	1140	3010	340	360	7,5	6	630	60/850B
900	1090	85	631	1627	360	380	5	4	160	618/900
	1180	122	868	2319	340	360	6	5	350	619/900
	1280	170	1130	3300	320	330	7,5	6	720	60/900
950	1150	90	639	1802	340	350	5	4	190	618/950

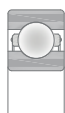

M

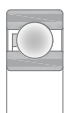

TN

Main dimensions			Basic load ratings		Speed ratings		Dimensions		Mass	Designation
d	D	B	Dynamic C	Static C ₀	Reference	Limiting	r _{1,2min}	r _{amax}		
[mm]			[kN]		[rpm]		[mm]		[kg]	–
950	1250	132	1030	2990	320	330	7,5	6	390	619/950
	1360	180	1150	3450	300	320	7,5	6	860	60/950
1000	1220	100	668	1833	730	510	6	5	245	618/1000
	1220	71	549	1576	320	320	5	4	175	608/1000
	1320	103	832	2468	310	310	6	5	410	609/1000
	1320	140	1000	2950	300	320	7,5	6	515	619/1000
	1420	185	1350	4050	270	290	7,5	6	930	60/1000
1060	1280	100	725	2194	640	460	6	5	260	618/1060
	1400	150	1030	3080	270	280	7,5	6	620	619/1060
	1500	195	1370	3990	250	270	9,5	8	1080	60/1060
1120	1360	106	763	2354	600	450	6	5	315	618/1120
	1460	150	1040	3180	–	–	7,5	6	650	619/1120
	1580	200	1480	4740	–	–	9,5	8	1250	60/1120
1180	1420	106	756	2459	540	400	6	5	330	618/1180
	1540	160	1130	3770	–	–	7,5	6	775	619/1180
1250	1500	112	856	2867	–	–	6	5	385	618/1250
1320	1600	122	968	3183	–	–	6	5	500	618/1320
	1720	128	1260	4190	–	–	7,5	6	830	609/1320
1400	1700	132	1160	4140	–	–	7,5	6	615	618/1400
	1820	185	1610	5830	–	–	9,5	8	1250	619/1400
1500	1820	140	1240	4620	–	–	7,5	6	745	618/1500
	1950	195	1710	6280	–	–	9,5	8	1500	619/1500
1600	1950	155	1290	4940	–	–	7,5	6	965	618/1600
	2060	200	1850	7360	–	–	9,5	8	1650	619/1600
1700	2060	160	1250	5090	–	–	7,5	6	1100	618/1700
	2180	212	2020	8200	–	–	9,5	8	1950	619/1700

Deep groove ball bearings

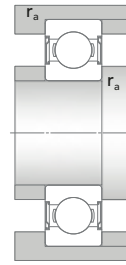
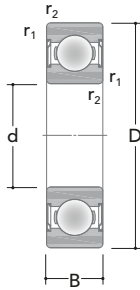

ZZ

Main dimensions			Basic load ratings		Speed ratings		Dimensions		Mass	Designation	
d	D	B	Dynamic C	Static C ₀	Reference	Limiting	r _{1,2min}	r _{amax}		Sealed on both sides	Sealed on one side
[mm]			[kN]		[rpm]		[mm]		[kg]	–	–
3	10	4	0,52	0,18	124000	65600	0,15	0,1	0,0015	623 ZZ	623 Z
	10	4	0,52	0,18	–	33000	0,15	0,1	0,0015	623 2RS	623 RS
4	9	3,5	0,52	0,18	134000	60300	0,1	0,1	0,001	628/4 ZZ	–
	9	4	0,52	0,18	134000	57600	0,1	0,1	0,0013	638/4 ZZ	–
	11	4	0,61	0,18	127000	68700	0,15	0,1	0,0017	619/4 ZZ	–
	12	4	0,78	0,28	116000	63600	0,2	0,2	0,0021	604 ZZ	604 Z
	13	5	0,91	0,29	107000	56500	0,2	0,2	0,0031	624 ZZ	624 Z
	16	5	1,08	0,37	92600	51900	0,3	0,3	0,0054	634 ZZ	634 Z
	16	5	1,08	0,37	–	23600	0,3	0,3	0,0054	634 2RS	634 RS
5	11	4	0,62	0,26	115000	50500	0,15	0,1	0,0014	628/5 ZZ	–
	11	5	0,63	0,26	117000	52100	0,15	0,1	0,0016	638/5 ZZ	–
	13	4	0,86	0,33	107000	60700	0,2	0,2	0,0025	619/5 ZZ	–
	16	5	1,11	0,37	92400	50500	0,3	0,3	0,005	625 ZZ	625 Z
	19	6	2,28	0,93	77900	43100	0,3	0,3	0,0093	635 ZZ	635 Z
	19	6	2,28	0,93	–	20500	0,3	0,3	0,009	635 2RS	635 RS
6	13	5	0,85	0,35	106000	45300	0,15	0,1	0,0026	628/6 ZZ	–
	15	5	0,86	0,27	97600	54600	0,2	0,2	0,0039	619/6 ZZ	–
	19	6	2,27	0,94	77600	42000	0,3	0,3	0,0084	626 ZZ	626 Z
	19	6	2,27	0,94	–	19800	0,3	0,3	0,0084	626 2RS	626 RS
7	14	5	0,93	0,40	96800	42900	0,15	0,1	0,0031	628/7 ZZ	–
	17	5	1,02	0,37	86900	46200	0,3	0,3	0,0049	619/7 ZZ	–
	19	6	2,27	0,95	82300	44900	0,3	0,3	0,0084	607 ZZ	607 Z
	19	6	2,27	0,95	–	20000	0,3	0,3	0,0078	607 2RS	607 RS
	22	7	3,36	1,35	68000	37400	0,3	0,3	0,013	627 ZZ	627 Z
	22	7	3,36	1,35	–	19000	0,3	0,3	0,013	627 2RS	627 RS
8	16	5	1,30	0,56	88100	37700	0,2	0,2	0,0036	628/8 ZZ	–
	16	5	1,30	0,57	–	22000	0,2	0,2	0,0036	628/8 2RS	–
	16	6	1,30	0,57	87800	37100	0,2	0,2	0,0043	638/8 ZZ	–
	19	6	1,41	0,46	82200	45900	0,3	0,3	0,0071	619/8 ZZ	–
	19	6	1,41	0,46	–	20300	0,3	0,3	0,0071	619/8 2RS	–
	19	6	2,25	0,94	81600	35700	0,3	0,3	0,0072	607/8 ZZ	607/8 Z
	22	7	3,35	1,36	72800	40300	0,3	0,3	0,013	608 ZZ	608 Z
	22	7	3,35	1,36	–	18600	0,3	0,3	0,012	608 2RS	608 RS
	22	11	3,31	1,34	–	18400	0,3	0,3	0,016	630/8 2RS	–
	24	8	3,81	1,65	61400	33400	0,3	0,3	0,018	628 ZZ	628 Z
	24	8	3,81	1,65	–	15800	0,3	0,3	0,017	628 2RS	628 RS



2RS

Main dimensions			Basic load ratings		Speed ratings		Dimensions		Mass	Designation	
d	D	B	Dynamic C	Static C ₀	Reference	Limiting	r _{1,2min}	r _{amax}		Sealed on both sides	Sealed on one side
[mm]			[kN]		[rpm]		[mm]		[kg]	–	–
8	28	6	1,30	0,57	58700	25100	0,3	0,3	0,03	638 ZZ	638 Z
9	17	5	1,39	0,64	82600	37000	0,2	0,2	0,0043	628/9 ZZ	628/9 Z
	17	5	1,38	0,63	–	19800	0,2	0,2	0,0043	628/9 2RS	–
	20	6	2,25	0,96	76900	43000	0,3	0,3	0,0076	619/9 ZZ	–
	24	7	3,75	1,65	67300	36200	0,3	0,3	0,015	609 ZZ	609 Z
	24	7	3,75	1,65	–	16400	0,3	0,3	0,014	609 2RS	609 RS
	26	8	4,59	1,95	57900	31700	0,3	0,3	0,021	629 ZZ	629 Z
	26	8	4,59	1,95	–	15700	0,3	0,3	0,02	629 2RS	629 RS
10	19	5	1,65	0,81	76800	41300	0,3	0,3	0,0055	61800 ZZ	–
	19	5	1,65	0,81	–	18400	0,3	0,3	0,0055	61800 2RS	–
	22	6	2,60	1,25	67400	37500	0,3	0,3	0,01	61900 ZZ	–
	22	6	2,60	1,25	–	17300	0,3	0,3	0,01	61900 2RS	–
	26	8	4,58	1,93	64500	33300	0,3	0,3	0,02	6000 ZZ	6000 Z
	26	8	4,58	1,93	–	15700	0,3	0,3	0,019	6000 2RS	6000 RS
	26	12	4,45	1,95	–	16300	0,3	0,3	0,025	63000 2RS	–
	28	8	4,92	2,34	58200	31500	0,3	0,3	0,026	16100 ZZ	–
	30	9	5,28	2,35	54700	30800	0,6	0,6	0,034	6200 ZZ	6200 Z
	30	9	5,28	2,35	–	13900	0,6	0,6	0,032	6200 2RS	6200 RS
	30	14	4,92	2,34	–	13900	0,6	0,6	0,04	62200 2RS	–
	35	11	8,22	3,38	48200	27600	0,6	0,6	0,055	6300 ZZ	6300 Z
	35	11	8,22	3,38	–	12700	0,6	0,6	0,053	6300 2RS	6300 RS
	35	17	7,74	3,37	–	12400	0,6	0,6	0,06	62300 2RS	–
12	21	5	1,69	0,90	68100	36200	0,3	0,3	0,0063	61801 ZZ	–
	21	5	1,69	0,90	–	16800	0,3	0,3	0,0063	61801 2RS	–
	24	6	2,84	1,44	65300	34200	0,3	0,3	0,011	61901 ZZ	–
	24	6	2,84	1,44	–	15900	0,3	0,3	0,011	61901 2RS	–
	28	8	5,28	2,36	58700	31400	0,3	0,3	0,022	6001 ZZ	6001 Z
	28	8	5,28	2,36	–	14000	0,3	0,3	0,021	6001 2RS	6001 RS
	28	12	4,91	2,33	–	14500	0,3	0,3	0,029	63001 2RS	–
	30	8	4,92	2,34	58400	25900	0,3	0,3	0,028	16101 ZZ	–
	30	8	4,92	2,34	–	13900	0,3	0,3	0,028	16101 2RS	–
	32	10	7,07	3,04	48500	27200	0,6	0,6	0,039	6201 ZZ	6201 Z
	32	10	7,07	3,04	–	12800	0,6	0,6	0,038	6201 2RS	6201 RS
	32	14	6,70	3,05	–	12700	0,6	0,6	0,045	62201 2RS	–
	37	12	9,81	4,11	43600	23500	1	1	0,063	6301 ZZ	6301 Z
	37	12	9,81	4,11	–	11700	1	1	0,06	6301 2RS	6301 RS
15	24	5	1,83	1,08	57900	32800	0,3	0,3	0,0074	61802 ZZ	–

Deep groove ball bearings

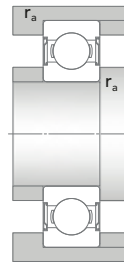
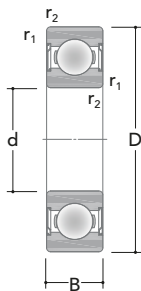

ZZ

Main dimensions			Basic load ratings		Speed ratings		Dimensions		Mass	Designation	
d	D	B	Dynamic C	Static C ₀	Reference	Limiting	r _{1,2min}	r _{amax}		Sealed on both sides	Sealed on one side
[mm]			[kN]		[rpm]		[mm]		[kg]	-	
15	24	5	1,83	1,08	-	14000	0,3	0,3	0,0074	61802 2RS	-
	28	7	4,21	2,21	54000	29000	0,3	0,3	0,016	61902 ZZ	-
	28	7	4,21	2,21	-	13300	0,3	0,3	0,016	61902 2RS	-
	32	8	5,71	2,81	48600	21400	0,3	0,3	0,025	16002 ZZ	16002 Z
	32	9	5,66	2,82	48400	26800	0,3	0,3	0,032	6002 ZZ	6002 Z
	32	9	5,66	2,82	-	11600	0,3	0,3	0,03	6002 2RS	6002 RS
	32	13	5,46	2,81	-	11700	0,3	0,3	0,039	63002 2RS	-
	35	11	7,80	3,71	41600	23700	0,6	0,6	0,048	6202 ZZ	6202 Z
	35	11	7,80	3,71	-	11200	0,6	0,6	0,046	6202 2RS	6202 RS
	35	14	7,60	3,69	-	10700	0,6	0,6	0,054	62202 2RS	-
	42	13	11,6	5,39	37100	20500	1	1	0,086	6302 ZZ	6302 Z
	42	13	11,6	5,39	-	10300	1	1	0,085	6302 2RS	6302 RS
42	17	11,1	5,30	-	9970	1	1	0,11	62302 2RS	-	
17	26	5	1,96	1,25	54000	28300	0,3	0,3	0,0082	61803 ZZ	-
	26	5	1,96	1,25	-	13500	0,3	0,3	0,0082	61803 2RS	-
	30	7	4,45	2,53	48100	26600	0,3	0,3	0,017	61903 ZZ	-
	30	7	4,45	2,53	-	11800	0,3	0,3	0,017	61903 2RS	-
	35	8	6,19	3,23	43700	18300	0,3	0,3	0,032	16003 ZZ	-
	35	10	6,21	3,23	43800	23300	0,3	0,3	0,041	6003 ZZ	6003 Z
	35	10	6,21	3,23	-	10800	0,3	0,3	0,039	6003 2RS	6003 RS
	35	14	5,85	3,24	-	11000	0,3	0,3	0,052	63003 2RS	-
	40	12	9,71	4,73	37000	19800	0,6	0,6	0,068	6203 ZZ	6203 Z
	40	12	9,71	4,73	-	10100	0,6	0,6	0,067	6203 2RS	6203 RS
	40	16	9,33	4,73	-	10200	0,6	0,6	0,089	62203 2RS	-
	47	14	13,9	6,49	32900	18400	1	1	0,12	6303 ZZ	6303 Z
47	14	13,9	6,49	-	9300	1	1	0,12	6303 2RS	6303 RS	
47	19	13,2	6,52	-	9200	1	1	0,16	62303 2RS	-	
20	32	7	3,94	2,29	44000	23400	0,3	0,3	0,018	61804 ZZ	-
	32	7	3,94	2,29	-	11100	0,3	0,3	0,018	61804 2RS	-
	37	9	6,17	3,61	41600	21700	0,3	0,3	0,038	61904 ZZ	-
	37	9	6,17	3,61	-	9900	0,3	0,3	0,038	61904 2RS	-
	42	12	9,67	4,96	36900	20200	0,6	0,6	0,071	6004 ZZ	6004 Z
	42	12	9,67	4,96	-	9000	0,6	0,6	0,067	6004 2RS	6004 RS
	42	16	9,11	4,92	-	9400	0,6	0,6	0,086	63004 2RS	-
	47	14	13,1	6,44	31100	17200	1	1	0,11	6204 ZZ	6204 Z
	47	14	13,1	6,44	-	8300	1	1	0,11	6204 2RS	6204 RS
	47	18	12,4	6,44	-	8300	1	1	0,13	62204 2RS	-
	52	15	16,2	7,66	28800	16000	1,1	1	0,15	6304 ZZ	6304 Z
	52	15	16,2	7,66	-	8000	1,1	1	0,15	6304 2RS	6304 RS

2RS

Main dimensions			Basic load ratings		Speed ratings		Dimensions		Mass	Designation	
d	D	B	Dynamic C	Static C ₀	Reference	Limiting	r _{1,2min}	r _{amax}		Sealed on both sides	Sealed on one side
[mm]			[kN]		[rpm]		[mm]		[kg]	–	–
20	52	21	15,6	7,80	–	7900	1,1	1	0,21	62304 2RS	–
22	50	14	13,5	7,51	–	7700	1	1	0,12	62/22 2RS	–
25	37	7	4,23	2,58	36800	20600	0,3	0,3	0,022	61805 ZZ	–
	37	7	4,23	2,58	–	9200	0,3	0,3	0,022	61805 2RS	–
	42	9	6,77	4,28	34700	18700	0,3	0,3	0,045	61905 ZZ	–
	42	9	6,77	4,28	–	8300	0,3	0,3	0,045	61905 2RS	–
	47	12	11,5	6,44	30800	16600	0,6	0,6	0,083	6005 ZZ	6005 Z
	47	12	11,5	6,44	–	8100	0,6	0,6	0,08	6005 2RS	6005 RS
	47	16	10,9	6,54	–	8100	0,6	0,6	0,11	63005 2RS	–
	52	15	14,3	7,70	27000	14800	1	1	0,13	6205 ZZ	6205 Z
	52	15	14,3	7,70	–	7200	1	1	0,13	6205 2RS	6205 RS
	52	18	13,5	7,66	–	7200	1	1	0,15	62205 2RS	–
	62	17	22,5	11,4	23100	13600	1,1	1	0,23	6305 ZZ	6305 Z
	62	17	22,5	11,4	–	6300	1,1	1	0,23	6305 2RS	6305 RS
	62	24	21,7	11,5	–	6100	1,1	1	0,32	62305 2RS	–
	30	42	7	4,39	2,89	31200	17300	0,3	0,3	0,025	61806 ZZ
42		7	4,39	2,89	–	7900	0,3	0,3	0,025	61806 2RS	–
47		9	7,12	4,54	29300	15900	0,3	0,3	0,05	61906 ZZ	–
47		9	7,12	4,54	–	7200	0,3	0,3	0,05	61906 2RS	–
55		13	13,3	8,27	27000	14500	1	1	0,12	6006 ZZ	6006 Z
55		13	13,3	8,27	–	6600	1	1	0,12	6006 2RS	6006 RS
55		19	12,9	8,28	–	6700	1	1	0,17	63006 2RS	–
62		16	19,5	11,0	23000	12000	1	1	0,2	6206 ZZ	6206 Z
62		16	19,5	11,0	–	6400	1	1	0,2	6206 2RS	6206 RS
62		20	18,9	11,2	–	6200	1	1	0,25	62206 2RS	–
72		19	28,6	15,8	19200	10000	1,1	1	0,36	6306 ZZ	6306 Z
72		19	28,6	15,8	–	5200	1,1	1	0,36	6306 2RS	6306 RS
72		27	27,0	15,9	–	5400	1,1	1	0,5	62306 2RS	–
35	47	7	4,25	3,30	29200	15000	0,3	0,3	0,03	61807 ZZ	–
	47	7	4,25	3,30	–	7100	0,3	0,3	0,022	61807 2RS	–
	55	10	10,5	7,79	25100	13700	0,6	0,6	0,08	61907 ZZ	–
	55	10	10,5	7,79	–	6300	0,6	0,6	0,08	61907 2RS	–
	62	14	16,3	10,2	23200	12400	1	1	0,16	6007 ZZ	6007 Z
	62	14	16,3	10,2	–	5900	1	1	0,16	6007 2RS	6007 RS
	62	20	15,5	10,1	–	5800	1	1	0,23	63007 2RS	–
	72	17	26,1	15,1	19300	10000	1,1	1	0,3	6207 ZZ	6207 Z
	72	17	26,1	15,1	–	5200	1,1	1	0,3	6207 2RS	6207 RS

Deep groove ball bearings

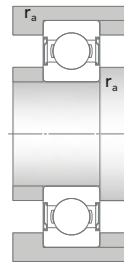
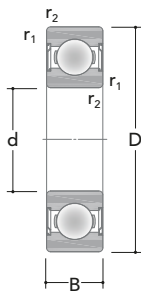

ZZ

Main dimensions			Basic load ratings		Speed ratings		Dimensions		Mass	Designation	
d	D	B	Dynamic C	Static C ₀	Reference	Limiting	r _{1,2min}	r _{amax}		Sealed on both sides	Sealed on one side
[mm]			[kN]		[rpm]		[mm]		[kg]	-	
35	72	23	24,9	15,2	-	5300	1,1	1	0,4	62207 2RS	-
	80	21	33,7	18,6	18200	10000	1,5	1,5	0,48	6307 ZZ	6307 Z
	80	21	33,7	18,6	-	5200	1,5	1,5	0,47	6307 2RS	6307 RS
	80	31	32,4	18,7	-	5000	1,5	1,5	0,68	62307 2RS	-
40	52	7	4,39	3,70	25400	13500	0,3	0,3	0,034	61808 ZZ	-
	52	7	4,39	3,70	-	6100	0,3	0,3	0,034	61808 2RS	-
	62	12	13,5	9,86	23400	11900	0,6	0,6	0,12	61908 ZZ	-
	62	12	13,5	9,86	-	5500	0,6	0,6	0,12	61908 2RS	-
	68	15	17,4	10,8	21400	11000	1	1	0,2	6008 ZZ	6008 Z
	68	15	17,4	10,8	-	5300	1	1	0,2	6008 2RS	6008 RS
	68	21	16,4	10,9	-	5300	1	1	0,27	63008 2RS	-
	80	18	31,4	18,9	17300	9500	1,1	1	0,38	6208 ZZ	6208 Z
	80	18	31,4	18,9	-	4600	1,1	1	0,38	6208 2RS	6208 RS
	80	23	29,6	18,9	-	4700	1,1	1	0,47	62208 2RS	-
	90	23	41,1	23,8	16500	9000	1,5	1,5	0,65	6308 ZZ	6308 Z
	90	23	41,1	23,8	-	4200	1,5	1,5	0,65	6308 2RS	6308 RS
90	33	39,9	23,6	-	4100	1,5	1,5	0,92	62308 2RS	-	
45	58	7	6,41	6,02	21200	11000	0,3	0,3	0,04	61809 ZZ	-
	58	7	6,41	6,02	-	5700	0,3	0,3	0,04	61809 2RS	-
	68	12	13,6	10,7	19400	11000	0,6	0,6	0,14	61909 ZZ	-
	68	12	13,6	10,7	-	5000	0,6	0,6	0,14	61909 2RS	-
	75	16	21,5	14,5	19400	9800	1	1	0,25	6009 ZZ	6009 Z
	75	16	21,5	14,5	-	4800	1	1	0,25	6009 2RS	6009 RS
	75	23	20,4	14,6	-	4800	1	1	0,36	63009 2RS	-
	85	19	34,2	21,3	16500	9400	1,1	1	0,43	6209 ZZ	6209 Z
	85	19	34,2	21,3	-	4100	1,1	1	0,43	6209 2RS	6209 RS
	85	23	32,0	21,2	-	4200	1,1	1	0,51	62209 2RS	-
	100	25	53,8	31,3	14600	8000	1,5	1,5	0,87	6309 ZZ	6309 Z
	100	25	53,8	31,3	-	3700	1,5	1,5	0,87	6309 2RS	6309 RS
100	36	51,6	31,1	-	3800	1,5	1,5	1,2	62309 2RS	-	
50	65	7	6,55	6,73	19300	11000	0,3	0,3	0,052	61810 ZZ	-
	65	7	6,55	6,73	-	5100	0,3	0,3	0,052	61810 2RS	-
	72	12	14,0	11,7	18200	10000	0,6	0,6	0,14	61910 ZZ	-
	72	12	14,0	11,7	-	4700	0,6	0,6	0,14	61910 2RS	-
	80	16	22,4	15,8	17600	9500	1	1	0,27	6010 ZZ	6010 Z
	80	16	22,4	15,8	-	4100	1	1	0,27	6010 2RS	6010 RS
	80	23	21,1	15,4	-	4300	1	1	0,38	63010 2RS	-
	90	20	36,0	22,7	14500	8600	1,1	1	0,47	6210 ZZ	6210 Z

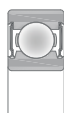

2RS

Main dimensions			Basic load ratings		Speed ratings		Dimensions		Mass	Designation	
d	D	B	Dynamic C	Static C ₀	Reference	Limiting	r _{1,2min}	r _{amax}		Sealed on both sides	Sealed on one side
[mm]			[kN]		[rpm]		[mm]		[kg]	–	
50	90	20	36,0	22,7	–	4100	1,1	1	0,47	6210 2RS	6210 RS
	90	23	34,0	23,1	–	4000	1,1	1	0,54	62210 2RS	–
	110	27	63,4	37,8	12600	7200	2	2	1,1	6310 ZZ	6310 Z
	110	27	63,4	37,8	–	3600	2	2	1,1	6310 2RS	6310 RS
	110	40	60,4	37,5	–	3700	2	2	1,6	62310 2RS	–
55	72	9	8,86	8,71	18600	10000	0,3	0,3	0,083	61811 ZZ	–
	72	9	8,86	8,71	–	4600	0,3	0,3	0,083	61811 2RS	–
	80	13	16,1	14,0	16600	9200	1	1	0,19	61911 ZZ	–
	80	13	16,1	14,0	–	4100	1	1	0,19	61911 2RS	–
	90	18	28,7	20,9	15400	8500	1,1	1	0,4	6011 ZZ	6011 Z
	90	18	28,7	20,9	–	3700	1,1	1	0,4	6011 2RS	6011 RS
	100	21	45,0	28,5	13600	7700	1,5	1,5	0,64	6211 ZZ	6211 Z
	100	21	45,0	28,5	–	3600	1,5	1,5	0,64	6211 2RS	6211 RS
	100	25	42,4	28,8	–	3500	1,5	1,5	0,75	62211 2RS	–
	120	29	71,3	44,6	11500	6600	2	2	1,4	6311 ZZ	6311 Z
	120	29	71,3	44,6	–	3200	2	2	1,4	6311 2RS	6311 RS
	120	43	70,0	45,0	–	3200	2	2	2,05	62311 2RS	–
	60	78	10	11,4	11,3	16300	9000	0,3	0,3	0,11	61812 ZZ
78		10	11,4	11,3	–	4000	0,3	0,3	0,11	61812 2RS	–
85		13	16,1	14,1	15600	8400	1	1	0,2	61912 ZZ	–
85		13	16,1	14,1	–	3700	1	1	0,2	61912 2RS	–
95		18	29,8	23,0	14500	8200	1,1	1	0,43	6012 ZZ	6012 Z
95		18	29,8	23,0	–	3600	1,1	1	0,43	6012 2RS	6012 RS
110		22	53,7	35,7	12600	6600	1,5	1,5	0,81	6212 ZZ	6212 Z
110		22	53,7	35,7	–	3300	1,5	1,5	0,81	6212 2RS	6212 RS
110		28	51,3	35,4	–	3300	1,5	1,5	1	62212 2RS	–
130		31	82,9	51,6	10600	5800	2,1	2	1,8	6312 ZZ	6312 Z
130		31	82,9	51,6	–	2800	2,1	2	1,8	6312 2RS	6312 RS
130		46	79,3	51,4	–	2800	2,1	2	2,55	62312 2RS	–
65		85	10	12,0	12,5	15400	8500	0,6	0,6	0,13	61813 ZZ
	85	10	12,0	12,5	–	3800	0,6	0,6	0,13	61813 2RS	–
	90	13	16,8	15,8	–	8000	1	1	0,22	61913 ZZ	–
	90	13	16,8	15,8	–	3700	1	1	0,22	61913 2RS	–
	100	18	31,2	24,7	13600	7400	1,1	1	0,46	6013 ZZ	6013 Z
	100	18	31,2	24,7	–	3300	1,1	1	0,46	6013 2RS	6013 RS
	120	23	57,3	40,0	11700	6300	1,5	1,5	1,05	6213 ZZ	6213 Z
	120	23	57,3	40,0	–	2900	1,5	1,5	1,05	6213 2RS	6213 RS
	120	31	54,5	40,3	–	3000	1,5	1,5	1,4	62213 2RS	–

Deep groove ball bearings

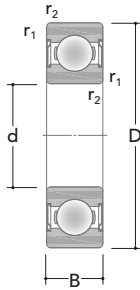

ZZ

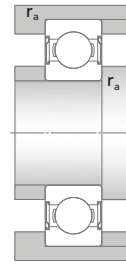

Main dimensions			Basic load ratings		Speed ratings		Dimensions		Mass	Designation	
d	D	B	Dynamic C ₀	Static C ₀	Reference	Limiting	r _{1,2min}	r _{amax}		Sealed on both sides	Sealed on one side
[mm]			[kN]		[rpm]		[mm]		[kg]	-	-
65	140	33	94,9	59,0	9700	5700	2,1	2	2,15	6313 ZZ	6313 Z
	140	33	94,9	59,0	-	2700	2,1	2	2,15	6313 2RS	6313 RS
	140	48	88,8	58,9	-	2600	2,1	2	3	62313 2RS	-
70	90	10	12,0	13,0	14400	7600	0,6	0,6	0,14	61814 ZZ	-
	90	10	12,0	13,0	-	3700	0,6	0,6	0,14	61814 2RS	-
	100	16	23,3	21,0	13700	7300	1	1	0,35	61914 ZZ	-
	100	16	23,3	21,0	-	3400	1	1	0,35	61914 2RS	-
	110	20	38,6	30,8	12600	6700	1,1	1	0,64	6014 ZZ	6014 Z
	110	20	38,6	30,8	-	3000	1,1	1	0,63	6014 2RS	6014 RS
	125	24	61,9	44,2	10600	6000	1,5	1,5	1,15	6214 ZZ	6214 Z
	125	24	61,9	44,2	-	2900	1,5	1,5	1,1	6214 2RS	6214 RS
	125	31	59,2	44,5	-	2800	1,5	1,5	1,4	62214 2RS	-
	150	35	108	66,7	9200	5300	2,1	2	2,65	6314 ZZ	6314 Z
	150	35	108	66,7	-	2500	2,1	2	2,6	6314 2RS	6314 RS
75	95	10	12,2	14,1	13400	7300	0,6	0,6	0,15	61815 ZZ	-
	95	10	12,2	14,1	-	3200	0,6	0,6	0,15	61815 2RS	-
	105	16	23,5	22,0	12600	6500	1	1	0,37	61915 ZZ	-
	105	16	23,5	22,0	-	3000	1	1	0,37	61915 2RS	-
	115	20	40,1	33,3	11500	6400	1,1	1	0,7	6015 ZZ	6015 Z
	115	20	40,1	33,3	-	2800	1,1	1	0,67	6015 2RS	6015 RS
	130	25	67,3	48,3	9700	5700	1,5	1,5	1,25	6215 ZZ	6215 Z
	130	25	67,3	48,3	-	2700	1,5	1,5	1,2	6215 2RS	6215 RS
	160	37	116	75,1	8700	4700	2,1	2	3,15	6315 ZZ	6315 Z
	160	37	116	75,1	-	2300	2,1	2	3,15	6315 2RS	6315 RS
	80	100	10	12,6	14,8	12500	6600	0,6	0,6	0,15	61816 ZZ
100		10	12,6	14,8	-	2900	0,6	0,6	0,15	61816 2RS	-
110		16	24,5	20,3	11600	6200	1	1	0,4	61916 ZZ	-
110		16	24,5	20,3	-	2900	1	1	0,4	61916 2RS	-
125		22	48,3	39,9	10700	6000	1,1	1	0,91	6016 ZZ	6016 Z
125		22	48,3	39,9	-	2600	1,1	1	0,89	6016 2RS	6016 RS
140		26	71,1	54,8	9200	5100	2	2	1,55	6216 ZZ	6216 Z
140		26	71,1	54,8	-	2400	2	2	1,5	6216 2RS	6216 RS
170		39	125	85,0	8100	4500	2,1	2	3,75	6316 ZZ	6316 Z
170		39	125	85,0	-	2100	2,1	2	3,7	6316 2RS	6316 RS
85	110	13	18,9	20,4	11600	6300	1	1	0,27	61817 ZZ	-
	110	13	18,9	20,4	-	2800	1	1	0,27	61817 2RS	-

2RS

Main dimensions			Basic load ratings		Speed ratings		Dimensions		Mass	Designation	
d	D	B	Dynamic C	Static C ₀	Reference	Limiting	r _{1,2min}	r _{amax}		Sealed on both sides	Sealed on one side
[mm]			[kN]		[rpm]		[mm]		[kg]	–	
85	130	22	50,8	42,5	10700	5700	1,1	1	0,96	6017 ZZ	6017 Z
	130	22	50,8	42,5	–	2400	1,1	1	0,94	6017 2RS	6017 RS
	150	28	85,1	63,8	8700	4800	2	2	1,9	6217 ZZ	6217 Z
	150	28	85,1	63,8	–	2300	2	2	1,9	6217 2RS	6217 RS
	180	41	135	95,1	7700	4200	3	2,5	4,4	6317 ZZ	6317 Z
	180	41	135	95,1	–	2000	3	2,5	4,35	6317 2RS	6317 RS
90	115	13	18,9	21,6	10600	5900	1	1	0,28	61818 ZZ	–
	115	13	18,9	21,6	–	2700	1	1	0,28	61818 2RS	–
	140	24	59,1	49,8	9700	5300	1,5	1,5	1,2	6018 ZZ	6018 Z
	140	24	59,1	49,8	–	2300	1,5	1,5	1,2	6018 2RS	6018 RS
	160	30	97,0	72,8	8100	4400	2	2	2,3	6218 ZZ	6218 Z
	160	30	97,0	72,8	–	2100	2	2	2,3	6218 2RS	6218 RS
	190	43	147	107	7200	4000	3	2,5	5,1	6318 ZZ	6318 Z
	190	43	147	107	–	2000	3	2,5	5,1	6318 2RS	6318 RS
95	120	13	19,3	22,8	10600	5500	1	1	0,3	61819 ZZ	–
	120	13	19,4	22,7	–	2500	1	1	0,3	61819 2RS	–
	130	18	32,9	33,3	–	2400	1,1	1	0,65	61919 2RS	–
	145	24	62,2	53,8	9200	5200	1,5	1,5	1,25	6019 ZZ	6019 Z
	145	24	62,2	53,8	–	2300	1,5	1,5	1,25	6019 2RS	6019 RS
	170	32	110	80,7	7600	4100	2,1	2	2,75	6219 ZZ	6219 Z
	170	32	110	80,7	–	2000	2,1	2	2,75	6219 2RS	6219 RS
	200	45	153	117	6700	3800	3	2,5	5,85	6319 ZZ	6319 Z
	200	45	153	117	–	1800	3	2,5	5,85	6319 2RS	6319 RS
	100	125	13	17,4	18,1	9780	5300	1	1	0,31	61820 ZZ
125		13	17,4	18,1	–	2400	1	1	0,31	61820 2RS	61820 RS
150		24	61,3	53,0	9130	4600	1,5	1,5	1,35	6020 ZZ	6020 Z
150		24	61,3	53,0	–	2200	1,5	1,5	1,3	6020 2RS	6020 RS
180		34	123	92,7	7240	4100	2,1	2	3,3	6220 ZZ	6220 Z
180		34	123	92,7	–	2000	2,1	2	3,3	6220 2RS	6220 RS
215		47	170	138	6530	3500	3	2,5	7,3	6320 ZZ	6320 Z
215		47	170	138	–	1700	3	2,5	7,1	6320 2RS	6320 RS
105	130	13	20,3	19,3	9700	5400	1	1	0,32	61821 ZZ	–
	130	13	20,3	19,3	–	2300	1	1	0,32	61821 2RS	61821 RS
	160	26	73,6	64,6	8200	4300	2	2	1,65	6021 ZZ	6021 Z
	160	26	73,6	64,6	–	2000	2	2	1,65	6021 2RS	6021 RS
	190	36	134	103	6700	3600	2,1	2	3,9	6221 ZZ	6221 Z
	190	36	134	103	–	1800	2,1	2	3,95	6221 2RS	6221 RS

Deep groove ball bearings

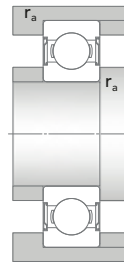
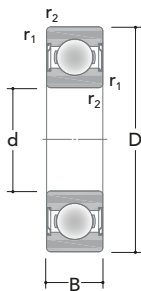

ZZ

Main dimensions			Basic load ratings		Speed ratings		Dimensions		Mass	Designation	
d	D	B	Dynamic C	Static C ₀	Reference	Limiting	r _{1,2min}	r _{amax}		Sealed on both sides	Sealed on one side
[mm]			[kN]		[rpm]		[mm]		[kg]	–	–
105	225	49	177	150	6100	3400	3	2,5	8,25	6321 ZZ	6321 Z
110	140	16	27,3	25,5	9200	4600	1	1	0,6	61822 ZZ	–
	140	16	27,3	25,5	–	2200	1	1	0,6	61822 2RS	–
	170	28	83,1	72,4	7800	4200	2	2	2,05	6022 ZZ	6022 Z
	170	28	83,1	72,4	–	2000	2	2	2,05	6022 2RS	6022 RS
	200	38	146	117	6400	3600	2,1	2	4,5	6222 ZZ	6222 Z
	200	38	146	117	–	1600	2,1	2	4,5	6222 2RS	6222 RS
	240	50	195	177	5700	3100	3	2,5	9,7	6322 ZZ	6322 Z
	240	50	195	177	–	1400	3	2,5	9,7	6322 2RS	6322 RS
120	150	16	28,2	27,7	8240	4500	1	1	0,65	61824 ZZ	–
	150	16	28,2	27,7	–	2000	1	1	0,65	61824 2RS	61824 RS
	180	28	86,5	79,1	7300	4100	2	2	2,2	6024 ZZ	6024 Z
	180	28	86,5	79,1	–	1900	2	2	2,15	6024 2RS	6024 RS
	215	40	142	117	6100	3300	2,1	2	5,35	6224 ZZ	6224 Z
	215	40	142	117	–	1600	2,1	2	5,3	6224 2RS	6224 RS
	260	55	201	185	5400	2900	3	2,5	12,7	6324 ZZ	6324 Z
	260	55	201	185	–	1400	3	2,5	12,6	6324 2RS	6324 RS
130	165	18	36,3	42,7	7700	4000	1,1	1	0,93	61826 ZZ	–
	165	18	36,3	42,7	–	1900	1,1	1	0,93	61826 2RS	61826 RS
	200	33	110	99,9	6800	3600	2	2	3,35	6026 ZZ	6026 Z
	200	33	110	99,9	–	1600	2	2	3,35	6026 2RS	6026 RS
	230	40	150	130	5300	3100	3	2,5	6	6226 ZZ	6226 Z
	230	40	150	130	–	1400	3	2,5	5,9	6226 2RS	6226 RS
140	175	18	38,1	46,4	7300	3700	1,1	1	0,99	61828 ZZ	–
	175	18	38,1	46,4	–	1700	1,1	1	0,99	61828 2RS	61828 RS
	210	33	107	107	6400	3200	2	2	3,6	6028 ZZ	6028 Z
	210	33	107	107	–	1500	2	2	3,55	6028 2RS	6028 RS
150	225	35	121	123	5800	3200	2,1	2	4,35	6030 ZZ	6030 Z
	225	35	121	123	–	1400	2,1	2	4,35	6030 2RS	6030 RS
160	240	38	140	143	5400	3000	2,1	2	5,35	6032 ZZ	6032 Z
	240	38	140	143	–	1300	2,1	2	5,3	6032 2RS	6032 RS

Angular contact ball bearings

The angular contact ball bearings (ACBBs) produced by RKB are used in a wide array of machines where combined loads, high speeds and runout accuracy are required. Available in single or double row configuration, they can be manufactured with different types of cage (machined brass, pressed steel or polyamide) and dimensional precisions.

Single row ACBBs can be directly paired by RKB in face-to-face (DF) or back-to-back (DB) configuration, depending on load conditions, presence of tilting moments and misalignment magnitude in the application.



Single row angular contact ball bearings

Misalignment

For single row angular contact ball bearing is not possible to determine a unique value of the shaft and housing misalignment. Permissible misalignment depends on several factors such as: the bearing size, internal axial clearance, arrangement, loads and moments

acting on it. A limited misalignment can be accommodated by paired bearings in back-to-back arrangement, even if the stresses inside the balls increase and consequently the bearing life will be reduced.

Minimum load

The minimum radial load is requested for single row angular contact ball bearing to guarantee an adequate operating condition, especially in particularly difficult working conditions like: high speed, high acceleration and sudden changes of direction. In these operating conditions, a skidding movement between the balls and raceways can be generated by the inertial forces, influencing negatively the bearing life.

Minimum radial load for single bearing and paired bearings in tandem arrangement can be theoretically estimated using this formula:

$$\frac{F_m}{C_r} > 0,015$$

where:

- F_m minimum radial load, [kN];
- C_r basic dynamic radial load, [kN].

Usually, the minimum radial load is reached or surpassed by the weight of the components supported by the bearing together with the loads acting on it, otherwise supplementary radial load must be applied on the single row angular contact ball bearing. In application where a starting up at a low temperature is planned or a lubricant with high viscosity is used, a larger value of the minimum radial load is required.

It is possible to apply an axial preload for single bearing and paired bearings in tandem arrangement by adjusting one ring against the other one or by using springs.

Designs and variants

Type M

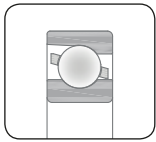

- One-piece inner and outer ring
- One-piece machined brass cage guided on balls (M)
- Available with machined brass cage guided on inner ring (MB)
- Single (non-universal) bearing execution
- Suitable for very high operating speeds
- Available with 25°, 30° or 40° contact angle

Type DF

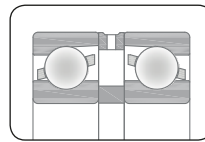

- Face-to-face arrangement (DF) of two ACBBs
- One-piece machined brass cage guided on balls (M)
- Preset or adjusted BEP on customer's request

Type DB

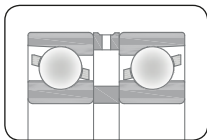

- Back-to-back arrangement (DB) of two ACBBs
- One-piece machined brass cage guided on balls (M)
- Preset or adjusted BEP on customer's request
- Available with machined brass cage guided on inner ring (MB)
- Available with inner and/or outer spacers featuring lubrication grooves and/or lubrication holes
- Stiffer arrangement to withstand tilting moments

Angular contact ball bearings

Prefixes

ACBB	Out of standard single row angular contact ball bearing followed by drawing number
ACBBF	Out of standard single row angular contact ball bearing with flanged outer ring followed by drawing number

Suffixes

Internal design

A	Bearing with a 30° contact angle
AC	Bearing with a 25° contact angle
B	Bearing with a 40° contact angle

Suffixes

Cage

M	Step-type or straight-type machined brass cage guided on balls
MB	Machined brass cage guided on inner ring
MBS	Machined brass cage guided on inner ring with lubrication grooves in the guiding surface
TN or ATN	Molded polyamide cage (PA66) guided on balls
TN9	Molded glass fiber-reinforced polyamide cage (PA66-GF25) guided on balls

Suffixes

Accuracy, clearance, running

A... - ...	Special axial internal clearance. The two numbers immediately following the A give minimum and maximum axial internal clearance in μm
A...	Special axial internal clearance. The number immediately following the A gives mean axial internal clearance in μm
U	Bearing for universal paired mounting. When in back-to-back or face-to-face arrangement there will be axial internal clearance
GA	Bearing for paired mounting. When in back-to-back or face-to-face arrangement there will be a light preload
GB	Bearing for paired mounting. When in back-to-back or face-to-face arrangement there will be a moderate preload
GC	Bearing for paired mounting. When in back-to-back or face-to-face arrangement there will be a heavy preload
CA	Bearing for paired mounting. When in back-to-back or face-to-face arrangement the axial internal clearance will be smaller than normal (CB)
CB	Bearing for paired mounting. When in back-to-back or face-to-face arrangement the axial internal clearance will be normal
CC	Bearing for paired mounting. When in back-to-back or face-to-face arrangement the axial internal clearance will be greater than normal (CB)

Suffixes	External design
Z	Shield on one side
ZZ or 2Z	Shield on both sides
N1	One locating slot in outer ring
N2	Two locating slots in outer ring

Suffixes	Set
DB	Two bearings matched for mounting back-to-back
DF	Two bearings matched for mounting face-to-face
DT	Two bearings matched for mounting in tandem

Single row angular contact ball bearings

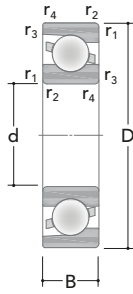

M

Main dimensions			Basic load ratings		Speed ratings		Dimensions				Mass	Designation
d	D	B	Dynamic C	Static C ₀	Reference	Limiting	r _{1,2min}	r _{3,4min}	r _{amax}	r _{bmax}		Standard design
[mm]			[kN]		[rpm]		[mm]				[kg]	-
10	30	9	6,79	3,34	29000	25700	0,6	0,3	0,6	0,3	0,03	7200
12	32	10	7,39	3,76	25200	21300	0,6	0,3	0,6	0,3	0,036	7201
	37	12	10,2	4,98	23100	20500	1	0,6	1	0,6	0,06	7301
15	35	11	8,48	4,57	25000	22100	0,6	0,3	0,6	0,3	0,045	7202
	42	13	12,5	6,57	19200	17200	1	0,6	1	0,6	0,08	7302
17	40	12	10,6	5,74	21100	18200	0,6	0,6	0,6	0,6	0,065	7203
	47	14	15,5	8,25	18500	16400	1	0,6	1	0,6	0,11	7303
20	47	14	13,8	8,04	18300	15600	1	0,6	1	0,6	0,11	7204
	52	15	18,3	9,92	17300	15100	1,1	0,6	1	0,6	0,14	7304
25	52	15	15,3	9,88	16600	14200	1	0,6	1	0,6	0,13	7205
	62	17	25,7	15,3	14500	12400	1,1	0,6	1	0,6	0,23	7305
30	62	16	23,5	15,4	13600	11700	1	0,6	1	0,6	0,2	7206
	72	19	34,4	21,2	12500	11100	1,1	0,6	1	0,6	0,34	7306
35	72	17	30,0	20,5	11500	10300	1,1	0,6	1	0,6	0,28	7207
	80	21	40,1	26,4	10600	9400	1,5	1	1,5	1	0,45	7307
40	80	18	36,8	25,9	10700	9100	1,1	0,6	1	0,6	0,37	7208
	90	23	48,0	32,2	9600	8500	1,5	1	1,5	1	0,68	7308
45	85	19	37,2	28,2	9700	8300	1,1	0,6	1	0,6	0,42	7209
	100	25	59,7	40,0	8800	7400	1,5	1	1,5	1	0,82	7309
50	90	20	39,1	30,9	8800	7800	1,1	0,6	1	0,6	0,47	7210
	110	27	72,4	50,2	7700	6600	2	1	2	1	1,1	7310
55	100	21	47,7	39,8	7700	6800	1,5	1	1,5	1	0,62	7211
	120	29	81,9	59,0	6700	5700	2	1	2	1	1,4	7311
60	110	22	58,7	49,1	7200	6100	1,5	1	1,5	1	0,8	7212
	130	31	100	75,4	6400	5600	2,1	1,1	2	1	1,75	7312
65	120	23	67,7	56,1	6500	5500	1,5	1	1,5	1	1	7213
	140	33	112	84,9	6000	5300	2,1	1,1	2	1	2,15	7313

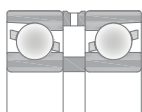

DB

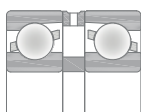

DF

Main dimensions			Basic load ratings		Speed ratings		Dimensions				Mass	Designation
d	D	B	Dynamic C	Static C ₀	Reference	Limiting	r _{1,2min}	r _{3,4min}	r _{amax}	r _{bmax}		Standard design
[mm]			[kN]		[rpm]		[mm]				[kg]	-
70	125	24	72,8	62,8	6100	5200	1,5	1	1,5	1	1,1	7214
	150	35	122	96,4	5300	4600	2,1	1,1	2	1	2,65	7314
75	130	25	71,7	64,5	6100	5300	1,5	1	1,5	1	1,2	7215
	160	37	128	104	5100	4600	2,1	1,1	2	1	3,2	7315
80	140	26	82,5	74,3	5400	4600	2	1	2	1	1,45	7216
	170	39	139	118	4800	4200	2,1	1,1	2	1	3,8	7316
85	150	28	99,1	88,3	5100	4500	2	1	2	1	1,85	7217
	180	41	152	131	4600	4000	3	1,1	2,5	1	4,45	7317
90	160	30	112	102	4800	4100	2	1	2	1	2,3	7218
	190	43	160	145	4300	3700	3	1,1	2,5	1	5,2	7318
95	170	32	124	116	4600	3900	2,1	1,1	2	1	2,7	7219
	200	45	176	161	4100	3600	3	1,1	2,5	1	6,05	7319
100	180	34	138	132	4300	3700	2,1	1,1	2	1	3,3	7220
	215	47	208	206	3800	3300	3	1,1	2,5	1	7,5	7320
105	190	36	153	148	4200	3700	2,1	1,1	2	1	3,95	7221
	225	49	210	204	3600	3100	3	1,1	2,5	1	8,55	7321
110	170	21	74,1	82,4	2900	3300	1	1	1	1	1,7	307536
	200	38	159	155	3900	3300	2,1	1,1	2	1	4,6	7222
	240	50	235	245	3500	3000	3	1,1	2,5	1	10	7322
120	180	28	84,0	91,6	3600	3300	2	1	2	1	2,4	7024
	215	40	161	162	3300	3100	2,1	1,1	2	1	5,9	7224
	260	55	229	248	2800	2500	3	1,5	2,5	1	14,5	7324
130	230	40	180	193	3100	2900	3	1,1	2,5	1	6,95	7226
	280	58	265	299	2600	2300	4	1,5	3	1,5	17	7326
140	210	33	110	128	3000	2900	2	1	2	1	3,85	7028
	250	42	193	210	2900	2600	3	1,1	2,5	1	8,85	7228
	300	62	291	343	2500	2100	4	1,5	3	1,5	21,5	7328
150	210	28/25	92,1	111	1800	2300	2	1	2	1	295	307377
	225	35	130	144	2900	2600	2,1	1,1	2	1	4,7	7030

Single row angular contact ball bearings

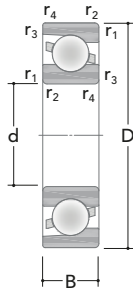

M



Main dimensions			Basic load ratings		Speed ratings		Dimensions				Mass	Designation
d	D	B	Dynamic C	Static C ₀	Reference	Limiting	r _{1,2min}	r _{3,4min}	r _{amax}	r _{bmax}		Standard design
[mm]			[kN]		[rpm]		[mm]				[kg]	-
150	270	45	211	239	2500	2400	3	1,1	2,5	1	11,5	7230
	320	65	322	390	2300	2000	4	1,5	3	1,5	26	7330
160	215	28	81,1	108	1800	2400	2	1	2	1	2,7	466896
	240	38	140	164	1700	2100	2,1	1,1	2	1	5,75	7032
	290	48	247	296	2300	2200	3	1,1	2,5	1	14	7232
	290	48	194	235	1500	1900	3	1,1	2,5	1	14	7232
170	260	42	166	203	2500	2300	2,1	1,1	2	1	7,65	7034
	310	52	274	343	2300	2000	4	1,5	3	1,5	17,5	7234
	310	52	215	266	1500	1800	4	1,5	3	1,5	17,5	7234
	360	72	380	482	1900	1800	4	2	3	2	36	7334
175	235	30/27	96,7	120	1700	2100	1,5	1	1,5	1	3,5	468325
180	280	46	190	238	2300	2200	2,1	1,1	2	1	10	7036
	320	52	282	371	2100	2000	4	1,5	3	1,5	18	7236
	380	75	397	539	1900	1700	4	2	3	2	42	7336
190	255	33/29	108	141	1600	2000	1,5	1	1,5	1	4,5	466880
	290	46	194	251	2300	1900	2,1	1,1	2	1	10,5	7038
	340	55	299	402	1900	1800	4	1,5	3	1,5	22	7238
	400	78	430	596	1800	1700	5	2	4	2	48,5	7338
200	310	51	218	284	2100	1800	2,1	1,1	2,1	1,1	18	7040
	360	58	314	424	1900	1600	4	1,5	3	1,5	25	7240
	420	80	448	648	1700	1500	5	2	4	2	53	7340
220	300	38/35	155	223	1400	1600	2	1	2	1	7,35	466931
	340	56	249	354	1900	1600	3	1,1	2,5	1,1	18	7044
	400	65	378	554	1700	1400	4	1,5	3	1,5	37	7244
	460	88	479	713	960	1200	5	2	4	2	70	7344
240	360	56	253	373	1700	1600	3	1,1	2,5	1,1	19	7048
	440	72	355	537	1500	1400	4	1,5	3	1,5	49	7248
	500	95	462	666	870	1100	5	2	5	2,5	88,5	7348
260	320	28	124	190	1300	1500	2	1,1	2	1	4,85	71852
	360	46	233	342	1200	1400	2,1	1,1	2	1	13,5	71952
	400	65	323	506	1500	1400	4	1,5	3	1,5	30	7052
	480	80	495	769	870	1000	5	2	4	2	66	7252

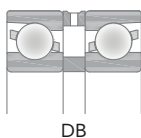

DB

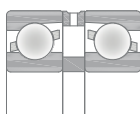

DF

Main dimensions			Basic load ratings		Speed ratings		Dimensions				Mass	Designation
d	D	B	Dynamic C	Static C ₀	Reference	Limiting	r _{1,2min}	r _{3,4min}	r _{amax}	r _{bmax}		Standard design
[mm]			[kN]		[rpm]		[mm]				[kg]	-
280	350	33	151	240	1100	1400	2	1	2	1	7,2	71856
	380	46	246	378	1000	1300	2,1	1,1	2	1	15	71956
	420	65	331	540	1400	1300	4	1,5	3	1,5	30	7056
	500	80	506	836	820	1000	5	2	4	2	69,5	7256
285	380	46	207	333	970	1200	2,1	1	2	1	14	466951
300	460	74	413	685	920	1200	4	1,5	3	1,5	42,5	7060
	540	65	541	928	830	1100	5	2,1	4	2	86,5	7260
	540	85	532	923	810	980	5	2,1	4	2	86,5	7260
320	480	74	423	721	870	1100	4	1,5	3	1,5	44,5	7064
	580	92	556	1000	820	980	5	2	4	2	110	7264
335	450	56	274	478	830	1020	3	1	2,5	1	25,5	466952
340	420	38	209	386	920	1200	2,1	1	2	1	10,5	71868
	460	56	324	579	860	1100	3	1,1	2,5	1	27	71968
	520	82	493	885	820	990	5	2	4	2	61,5	7068
	620	92	679	1320	720	840	6	3	5	2,5	125	7268
360	440	38	226	419	1700	2200	2,1	1,1	2	1	12	71872
	480	56	326	600	770	950	3	1,1	2,5	1	28,5	71972
	540	82	504	940	820	1000	5	2	4	2	62,5	7072
	650	95	633	1220	680	820	6	3	5	2,5	145	7272
380	480	31	185	340	820	1000	2	1	2	1	13,5	70876
	480	46	283	497	1600	2000	2,1	1,1	2	1	18	71876
	520	65	399	723	820	980	4	1,5	3	1,5	40,5	71976
	560	82	496	940	780	950	5	2	4	2	65,5	7076
400	540	65	409	777	770	940	4	1,5	3	1,5	42	71980
	600	90	584	1170	720	820	5	2	4	2	89,5	307238
	720	103	700	1480	570	650	6	3	5	2,5	190	7280
410	560	70	409	820	670	800	4	1	3	1	49,5	468431
420	560	65	408	795	720	850	4	1,5	3	1,5	445	71984
	620	90	592	1160	730	850	5	2	4	2	88,5	7084
440	650	94	626	1310	670	790	6	3	5	2,5	100	7088

Single row angular contact ball bearings

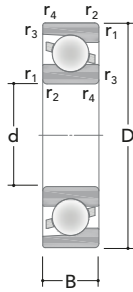

M

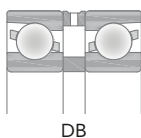
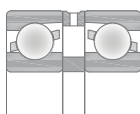

Main dimensions			Basic load ratings		Speed ratings		Dimensions				Mass	Designation
d	D	B	Dynamic C	Static C ₀	Reference	Limiting	r _{1,2min}	r _{3,4min}	r _{amax}	r _{bmax}		Standard design
[mm]			[kN]		[rpm]		[mm]				[kg]	-
460	580	37	257	554	720	850	2,1	1	2	1	24,5	70892
	580	56	357	752	720	850	3	3	2,5	2,5	34,5	71892
460	620	74	491	1020	820	1000	4	1,5	3	1,5	58	71992
	680	100	662	1430	640	750	6	3	5	2,5	120	7092
465	635	76	458	978	610	720	4	4	3	3	70,5	307352
480	700	100	687	1520	610	700	6	3	5	2,5	125	7096
500	620	37	266	617	640	740	2,1	1,1	2	1	27	708/500
	620	56	379	842	650	760	3	1,1	2,5	1	38	718/500
	670	78	536	1210	610	700	5	2	4	2	78	719/500
	720	100	686	1560	570	680	6	3	5	2,5	130	70/500
530	650	56	401	918	1000	1300	3	1,1	2,5	1	39,5	718/530
	710	82	603	1330	970	1200	5	2	4	2	92	719/530
	760	100	682	1580	540	640	6	6	5	5	150	307368
	780	112	876	2150	540	630	6	3	5	2,5	175	70/530
540	630	45	254	597	610	710	3	3	2,5	-	21,5	311585
560	680	56	383	926	570	690	3	1,1	2,5	1	41,5	718/560
	750	85	571	1270	540	610	5	2	4	2	105	719/560
	820	115	881	2120	510	580	6	3	5	2,5	195	70/560
600	730	42	331	735	540	620	3	1,1	2,5	1	38,5	708/600
	730	60	440	1080	540	620	3	1,1	2,5	1	47	718/600
	800	90	697	1710	870	1000	5	2	4	2	125	719/600
	870	118	855	2150	460	530	6	3	5	2,5	230	70/600
630	700	22	132	434	480	560	0,6	-	0,6	-	11,4	311712
670	820	69	535	1280	820	1000	4	1,5	3	1,5	80	718/670
	980	136	1140	3080	410	460	7,5	4	6	3	340	70/670
710	870	74	585	1600	770	950	4	1,5	3	1,5	93,5	718/710
	950	106	821	2160	770	950	6	3	5	2,5	195	719/710
	1030	140	1140	3180	380	450	7,5	4	6	3	370	70/710
750	920	78	625	1760	380	450	5	2	4	2	100	718/750
	1090	150	1260	3590	350	400	7,5	4	6	3	445	70/750

DB

DF

Main dimensions			Basic load ratings		Speed ratings		Dimensions				Mass	Designation
d	D	B	Dynamic C	Static C ₀	Reference	Limiting	r _{1,2min}	r _{3,4min}	r _{amax}	r _{bmax}		Standard design
[mm]			[kN]		[rpm]		[mm]				[kg]	–
762	889	63,5	433	1240	360	410	2,1	2,1	2	2	58	311576
800	1130	120	1050	3190	290	330	7,5	4	6	3	395	311745
	1150	155	1290	3720	330	380	7,5	4	6	3	500	70/800
850	1030	82	671	1820	330	380	5	2	4	2	140	718/850
	1220	165	1480	4560	290	340	7,5	4	6	3	595	70/850
900	1280	170	1490	4850	260	310	7,5	4	6	3	665	70/900
900												
950	1360	180	1590	5180	230	280	7,5	4	6	3	805	70/950
1000	1220	100	891	2700	250	300	6	3	5	2,5	245	718/1000
	1320	103	808	2400	230	280	6	6	5	5	370	307101
	1420	185	1580	5300	210	260	7,5	4	6	3	890	70/1000
1060	1500	195	1620	5670	190	250	9,5	5	8	4	1050	70/1060
1120	1360	106	1030	3700	190	260	6	3	5	2,5	320	718/1120
	1580	200	1680	5770	180	230	9,5	5	8	4	1150	70/1120
1180	1660	212	1690	6110	160	200	9,5	5	8	4	1350	70/1180
1250	1500	80	868	3510	170	210	6	3	5	2,5	295	708/1250
	1500	112	1110	3850	170	220	6	3	5	2,5	390	718/1250
	1750	218	1730	6450	150	180	9,5	5	8	4	1600	70/1250
1700	1900	80	938	4470	96	124	7,5	7,5	6	-	310	307756

Double row angular contact ball bearings

Can be considered in design similar to a pair of single row angular contact ball bearings in "O arrangement" or in a "X arrangement".

RKB double row angular contact ball bearings can accommodate thrust load as well as high radial load.

The bearings are normally used in arrangement requiring a rigid axial guidance. They can also withstand tilting moments.



Misalignment

According to the bearing internal design of double row angular contact ball bearings any misalignment may shorten the bearing service life, as well as give an increase of rotation noise.

Minimum load

A minimum axial load is requested for a thrust ball bearing, like for all ball and roller bearings, to guarantee an adequate operating conditions, especially in critical application requirements like: high speed, high

acceleration and sudden changes of rotating direction. In these operating conditions a skidding between balls and raceways can be generated by the inertial forces, influencing negatively the bearing life.

The requested minimum axial load can be theoretically estimated as follows:

$$\frac{F_{rm}}{C_r} > 0,015$$

where:

- F_{rm} minimum radial load, [kN];
- C_r basic dynamic radial load, [kN].

Usually, the minimum radial load is reached or surpassed by the weight of the components supported by the bearing together with the loads acting on it, otherwise supplementary radial load must be applied on the single row angular contact ball bearing. In application where a starting up at a low temperature is planned or a lubricant with high viscosity is used, a larger value of the minimum radial load is required.

Designs and variants

Type DF

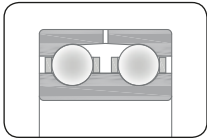

- Double row ACBB face-to-face arrangement (DF)
- Non-separable open design
- One-piece machined brass cage guided on inner ring (MB)
- Lubrication grooves and holes in outer rings
- Supports high combined loads

Type DB

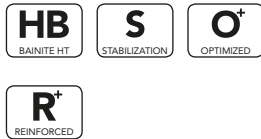
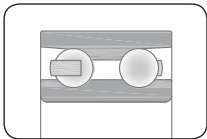

- Double row ACBB back-to-back arrangement (DB)
- Non-separable open design
- Moulded glass fiber reinforced polyamide snap-in cage guided on balls (TN)
- Available with lubrication holes in the inner ring
- Supports high combined loads

Seal type DB/ZZ

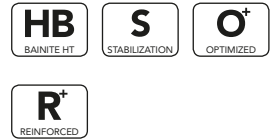
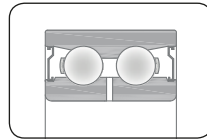

- Double row ACBB back-to-back arrangement (DB)
- Non-separable shielded design (ZZ)
- Moulded glass fiber reinforced polyamide snap-in cage guided on balls (TN)
- Available with lubrication holes in the inner ring
- Shielded type to keep the grease inside the bearing without compromising the limiting speed
- Supports high combined loads

Type DB/2RS

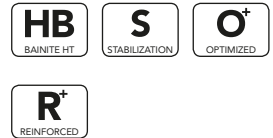
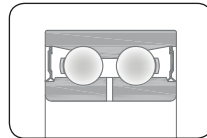

- Double row ACBB back-to-back arrangement (DB)
- Non-separable sealed design (2RS)
- Moulded glass fiber reinforced polyamide snap-in cage guided on balls (TN)
- Available with lubrication holes in the inner ring
- Sealed type to keep the grease inside the bearing without compromising the limiting speed
- Supports high combined loads

Double row angular contact ball bearings

Suffixes	Internal Design
D	Two-pieces inner ring
A	No filling slots
SP	Special or non-standard bearing

Suffixes	Cage
TN or ATN	Molded polyamide cage (PA66) guided on balls
TN9	Molded glass fiber-reinforced polyamide cage (PA66-GF25) guided on balls
M	Machined brass cage guided on balls

Suffixes	Accuracy, clearance, running
ABEC1	Approximated to tolerance class P0
ABEC3	Approximated to tolerance class P6
ABEC5	Approximated to tolerance class P5

Suffixes	External design
N2	Two locating slots in outer ring
RS	Contact seal on one side
2RS	Contact seal on both sides
Z	Shield on one side
ZZ or 2Z	Shield on both sides

Suffixes	Set
DF or X or DFX	Double row angular contact ball bearing in X arrangement
DB	Double row angular contact ball bearing in O arrangement

Double row angular contact ball bearings

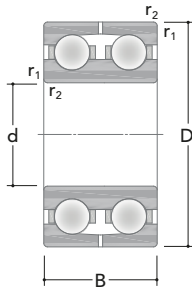

DF

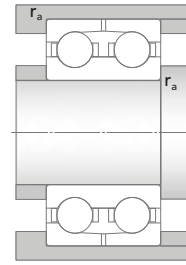

Main dimensions			Basic load ratings		Speed ratings		Dimensions		Mass	Designation
d	D	B	Dynamic	Static	Reference	Limiting	r _{1,2min}	r _{amax}		Standard design
[mm]			[kN]	C ₀	[rpm]		[mm]		[kg]	-
10	30	14	7,43	4,28	21400	20500	0,6	0,6	0,051	3200
12	32	15,9	9,73	5,51	19200	18300	0,6	0,6	0,058	3201
15	35	15,9	10,8	6,78	16400	14800	0,6	0,6	0,066	3202
	42	19	14,5	9,21	14400	13400	1	1	0,13	3303
17	40	17,5	13,9	8,80	14500	13400	0,6	0,6	0,096	3203
	47	22,2	20,8	12,6	13400	12000	1	1	0,18	3303
20	47	20,6	19,3	11,8	13400	11500	1	1	0,16	3204
	52	22,2	23,0	14,3	12600	11000	1,1	1	0,22	3304
25	52	20,6	21,1	14,1	11700	10400	1	1	0,18	3205
	62	25,4	31,1	20,1	10700	9400	1,1	1	0,35	3305
30	62	23,8	29,3	20,3	9700	8500	1	1	0,29	3206
	72	30,2	40,5	27,4	8700	7700	1,1	1	0,52	3306
35	72	27	38,6	27,9	8600	7700	1,1	1	0,44	3207
	80	34,9	50,9	35,5	8300	7300	1,5	1,5	0,74	3307
40	80	30,2	45,9	33,5	7700	6900	1,1	1	0,57	3208
	90	36,5	61,8	43,4	7200	6400	1,5	1,5	0,93	3308
45	85	30,2	49,3	38,9	7200	6400	1,1	1	0,63	3209
	100	39,7	73,1	52,2	6500	5700	1,5	1,5	1,25	3309
50	90	30,2	49,4	38,5	6700	6000	1,1	1	0,65	3210
	110	44,4	86,9	63,1	5700	5000	2	2	1,7	3310
55	100	33,3	58,1	46,9	6000	5400	1,5	1,5	0,91	3211
	120	49,2	109	81,0	5100	4400	2	2	2,65	3311
60	110	36,5	70,7	57,4	5300	4700	1,5	1,5	1,2	3212
	130	54	123	94,9	4800	4200	2,1	2	2,8	3312
65	120	38,1	78,9	73,4	4400	4000	1,5	1,5	1,75	3213
	140	58,7	141	109	4300	3700	2,1	2	4,1	3313
70	125	39,7	85,6	79,1	4100	3700	1,5	1,5	1,9	3214

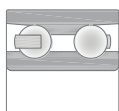

DB

Main dimensions			Basic load ratings		Speed ratings		Dimensions		Mass	Designation
d	D	B	Dynamic C	Static C ₀	Reference	Limiting	r _{1,2min}	r _{amax}		Standard design
[mm]			[kN]		[rpm]		[mm]		[kg]	–
70	150	63,5	158	125	4100	3600	2,1	2	5,05	3314
75	130	41,3	93,6	87,0	4200	3900	1,5	1,5	2,1	3215
	160	68,3	170	140	3800	3300	2,1	2	5,55	3315
80	140	44,4	103	93,4	3800	3600	2	2	2,65	3216
	170	68,3	188	155	3700	3100	2,1	2	6,8	3316
85	150	49,2	120	109	3400	3200	2	2	3,4	3217
	180	73,0	200	173	3400	3000	3	2,5	8,3	3317
90	160	52,4	127	119	3300	3000	2	2	4,15	3218
	190	73,0	203	179	3300	2800	3	2,5	9,25	3318
95	170	55,6	155	146	3100	2800	2,1	2	5	3219
	200	77,8	233	216	3100	2600	3	2,5	11	3319
100	170	60,3	131	144	2100	2600	2,1	2	5,35	305397
	180	60,3	152	216	1900	2400	2,1	2	6,1	3220
	215	82,6	249	353	1700	2100	3	2,5	13,5	3320
110	200	69,8	184	270	1800	2300	2,1	2	8,8	3222
	240	92,1	281	418	1600	2000	3	2,5	19	3322
120	190	66	185	236	1800	2300	2	2	6,6	309733
140	209,5	66	171	248	1600	2000	2	2	7,4	309515
150	225	73	191	273	1500	1800	2	2	9,5	305286
	230	70	197	285	1500	1900	2	2	10	305283
	240	84	243	335	1500	1900	2,1	2	16	305248
160	215	56/50	131	216	1500	1800	2	2	5,45	305608
	240	76	227	331	1400	1700	2,1	2	11	305183
170	260	84	274	399	1300	1600	2	2	15	305180
175	280	92	296	452	1200	1500	2,1	2	21	305351
180	250	70	194	281	1300	1500	2	2	10	305288
	250	70	184	282	1300	1500	2	2	9,95	305455

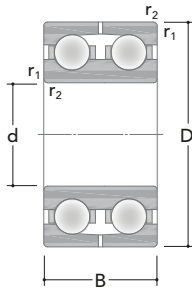
Double row angular contact ball bearings

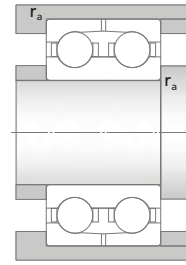

DF



Main dimensions			Basic load ratings		Speed ratings		Dimensions		Mass	Designation
d	D	B	Dynamic C	Static C ₀	Reference	Limiting	r _{1,2min}	r _{amax}		Standard design
[mm]			[kN]		[rpm]		[mm]		[kg]	-
	259	66	257	396	1300	1500	2,1	2	11	305262
	280	92	309	479	1200	1500	2,1	2	21,9	305172
190	255	66/58	173	283	1200	1400	1,5	1,5	9	305609
	269,5	66	262	415	1200	1500	2,1	2	11	305338
	290	92	315	510	1100	1400	2,1	2	20,5	305178
200	279,5	76	236	374	1100	1400	2,1	2	13	305428
	280	76	226	360	1100	1400	2,1	2	12,5	305237
	280	80	232	376	1100	1300	2,1	2	14,5	305393
	289,5	76	294	468	1100	1400	2,1	2	15,5	305263
	310	96	345	551	1000	1300	3	2,5	25,5	305352
220	300	76/70	250	442	1000	1300	2	2	14,5	305610
	309,5	76	305	518	970	1200	2,1	2	17	305272
230	329,5	80	343	592	920	1100	2,1	2	21	305264
250	340	76/70	307	566	910	1100	2,1	2	19	305611
260	369,5	92,0	385	696	820	1000	2,1	2	30	305270
	400	130	427	727	830	990	4	3	56	305174
280	389,5	92	393	747	820	990	2,1	2	31,5	305269
650	780	84	527	1730	350	390	4	3	81	309984
900	1030	135	654	2510	210	260	5	4	150	311631
1000	1170	140	801	3170	180	230	5	4	255	311495

Double row angular contact ball bearings

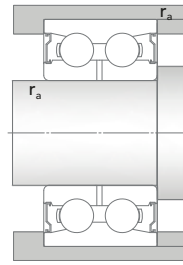
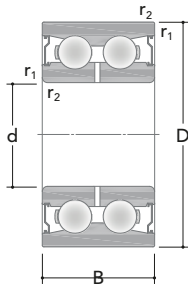

DB/ZZ

Main dimensions			Basic load ratings		Speed ratings		Dimensions		Mass	Designation	
d	D	B	Dynamic C	Static C ₀	Shields	Seals	r _{1,2min}	r _{amax}		Shielded	Sealed
[mm]			[KN]		[rpm]		[mm]		[Kg]	-	
10	30	14,3	7,43	4,28	20500	14400	0,6	0,6	0,051	3200 ZZ	3200 2RS
12	32	15,9	9,73	5,51	18300	12300	0,6	0,6	0,058	3201 ZZ	3201 2RS
15	35	15,9	10,8	6,78	14800	11600	0,6	0,6	0,066	3202 ZZ	3202 2RS
	42	19	14,5	9,21	13400	10100	1	1	0,13	3302 ZZ	3302 2RS
17	40	17,5	13,9	8,80	13400	10400	0,6	0,6	0,1	3203 ZZ	3203 2RS
	47	22,2	20,8	12,6	12000	9290	1	1	0,18	3303 ZZ	3303 2RS
20	47	20,6	19,3	11,8	11500	8530	1	1	0,16	3204 ZZ	3204 2RS
	52	22,2	23,0	14,3	11000	7380	1,1	1	0,22	3304 ZZ	3304 2RS
25	52	20,6	21,1	14,1	10400	7250	1	1	0,18	3205 ZZ	3205 2RS
	62	25,4	31,1	20,1	9490	6460	1,1	1	0,35	3305 ZZ	3305 2RS
30	62	23,8	29,3	20,3	8500	6300	1	1	0,29	3206 ZZ	3206 2RS
	72	30,2	40,5	27,4	7700	5200	1,1	1	0,52	3306 ZZ	3306 2RS
35	72	27	38,6	27,9	7700	5200	1,1	1	0,44	3207 ZZ	3207 2RS
	80	34,9	50,9	35,5	7300	4900	1,5	1,5	0,74	3307 ZZ	3307 2RS
40	80	30,2	45,9	33,5	6900	4700	1,1	1	0,57	3208 ZZ	3208 2RS
	90	36,5	61,8	43,4	6400	4200	1,5	1,5	0,93	3308 ZZ	3308 2RS
45	85	30,2	49,3	38,9	6400	4500	1,1	1	0,63	3209 ZZ	3209 2RS
	100	39,7	73,1	52,2	5700	4100	1,5	1,5	1,25	3309 ZZ	3309 2RS
50	90	30,2	49,4	38,5	6000	4000	1,1	1	0,65	3210 ZZ	3210 2RS
	110	44,4	86,9	63,1	5000	3600	2	2	1,7	3310 ZZ	3310 2RS
55	100	33,3	58,1	46,9	5400	3900	1,5	1,5	0,91	3211 ZZ	3211 2RS
	120	49,2	109	81,0	4400	3100	2	2	2,65	3311 ZZ	3311 2RS
60	110	36,5	70,7	57,4	4700	3400	1,5	1,5	1,2	3212 ZZ	3212 2RS
	130	54	123	94,9	4200	-	2,1	2	2,8	3312 ZZ	-
65	120	38,1	78,9	73,4	4000	2900	1,5	1,5	1,75	3213 ZZ	3213 2RS
	140	58,7	141	109	3700	-	2,1	2	4,1	3313 ZZ	-
70	125	39,7	85,6	79,06	3700	-	1,5	1,5	1,9	3214 ZZ	-

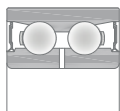

DB/2RS

Main dimensions			Basic load ratings		Speed ratings		Dimensions		Mass	Designation	
d	D	B	Dynamic C	Static C ₀	Shields	Seals	r _{1,2min}	r _{amax}		Shielded	Sealed
[mm]			[KN]		[rpm]		[mm]		[Kg]	-	
70	150	63,5	158	125	3600	-	2,1	2	5,05	3314 ZZ	-
75	130	41,3	93,6	87,02	3900	-	1,5	1,5	2,1	3215 ZZ	-
	160	68,3	170	140	3300	-	2,1	2	5,6	3315 ZZ	-

Four-point contact ball bearings

Four-point contact ball bearings are single row angular contact ball bearings featuring raceways designed to accommodate thrust loads acting in both directions. However radial loads can be partially supported up to a proportional value of axial load. This kind of bearing requires less space in axial direction than double row bearings.

Normally single row four-point contact ball bearings supporting thrust load in both direction are mounted together with another pure radial bearings. In this case the four-point contact ball bearings are mounted with radial clearance in the housing and they act as pure thrust bearings.



Misalignment

Four-point contact ball bearings can compensate partially the misalignments. This property is strictly connected with the residual internal clearance in operation, as well as tilting moments applied on the bearing.

However misalignments increase the noise during rotation and reduce the service life of the bearing.

Minimum load

In order to operate properly four-point contact ball bearings have to be subject to a minimum axial load. The requested value should prevent a higher level of friction as well as assure the contact among rolling elements and raceways only in one point.

According to these concepts the minimum axial load can be theoretically estimated as follows:

$$\frac{F_{am}}{C_r} > 1,25$$

where:

- F_{am} minimum axial load, [kN];
- C_r radial dynamic bearing load, [kN].

Designs and variants

Type Q

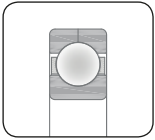

HB
BAINITE HT

S
STABILIZATION

- Two-pieces outer ring circumferentially split
- One-piece inner ring
- One-piece machined brass cage guided on inner ring (MB)
- Supports mainly axial loads
- Two locating slots (N2)

Type QJ

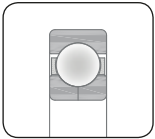

HB
BAINITE HT

S
STABILIZATION

- One-piece outer ring
- Two-pieces inner ring circumferentially split
- One-piece machined brass cage guided on outer ring (MA)
- Supports mainly axial loads
- Two locating slots (N2)

Four-point contact ball bearings

Suffixes	Cage
MA	Machined brass cage guided on outer ring
MB	Machined brass cage guided on inner ring

Suffixes	External design
N1	One locating slot in outer ring
N2	Two locating slots in outer ring

Four point contact ball bearings

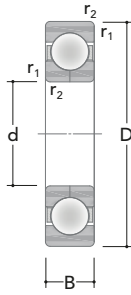

QJ

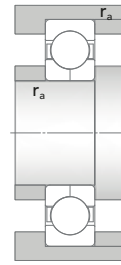

Main dimensions			Basic load ratings		Speed ratings		Dimensions		Mass	Designation
d	D	B	Dynamic C	Static C ₀	Reference	Limiting	r _{1,2min}	r _a max		
[mm]			[kN]		[rpm]		[mm]		[kg]	-
15	35	11	12,4	8,19	21400	30800	0,6	0,6	0,062	QJ 202
17	40	12	16,5	11,4	21200	24800	0,6	0,6	0,082	QJ 203
	47	14	22,7	14,9	16500	24100	1	1	0,14	QJ 303
20	52	15	30,9	21,5	17300	20000	1,1	1	0,18	QJ 304
25	52	15	25,9	21,0	15300	18400	1	1	0,16	QJ 205
	62	17	41,5	29,9	14600	17100	1,1	1	0,29	QJ 305
30	62	16	36,6	30,4	13600	15900	1	1	0,24	QJ 206
	72	19	51,8	41,4	11700	14500	1,1	1	0,42	QJ 306
35	72	17	47,5	41,5	11600	14200	1,1	1	0,35	QJ 207
	80	21	61,5	50,1	10500	12400	1,5	1,5	0,57	QJ 307
40	80	18	54,4	48,6	10600	12600	1,1	1	0,45	QJ 208
	90	23	76,4	64,0	9700	12100	1,5	1,5	0,78	QJ 308
45	85	19	61,5	55,8	9700	11800	1,1	1	0,52	QJ 209
	100	25	97,4	81,6	8700	10100	1,5	1,5	1,05	QJ 309
50	90	20	63,0	59,9	8600	10900	1,1	1	0,59	QJ 210
	110	27	116	98,9	7800	9300	2	2	1,35	QJ 310
55	100	21	83,3	83,0	7800	9300	1,5	1,5	0,77	QJ 211
	120	29	132	117	6700	8300	2	2	1,75	QJ 311
60	110	22	93,1	92,5	7200	8300	1,5	1,5	0,99	QJ 212
	130	31	151	136	6400	7700	2,1	2	2,15	QJ 312
65	120	23	107	110	6500	7800	1,5	1,5	1,2	QJ 213
	140	33	169	155	6000	6900	2,1	2	2,7	QJ 313
70	125	24	116	120	6000	7400	1,5	1,5	1,3	QJ 214
	150	35	196	180	5400	6800	2,1	2	3,15	QJ 314
75	130	25	120	130	6000	7200	1,5	1,5	1,45	QJ 215
	160	37	208	198	5100	6200	2,1	2	3,9	QJ 315
80	140	26	142	155	5400	6600	2	2	1,85	QJ 216

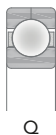

Main dimensions			Basic load ratings		Speed ratings		Dimensions		Mass	Designation
d	D	B	Dynamic C	Static C ₀	Reference	Limiting	r _{1,2min}	r _{amax}		
[mm]			[kN]		[rpm]		[mm]		[kg]	–
80	170	39	227	225	4800	5800	2,1	2	4,6	QJ 316
85	150	28	150	172	5000	6300	2	2	2,25	QJ 217
	180	41	244	251	4600	5500	3	2,5	5,45	QJ 317
90	160	30	179	199	4800	5900	2	2	2,75	QJ 218
	190	43	278	303	4300	5300	3	2,5	6,45	QJ 318
95	170	32	206	228	4600	5700	2,1	2	3,35	QJ 219
	200	45	297	338	4100	4900	3	2,5	7,45	QJ 319
100	150	24	102	133	3000	3500	1,5	1,52	1,60	QJ 1020
	180	34	228	264	4300	5200	2,1	2	4,05	QJ 220
	215	47	333	398	3800	4700	3	2	9,3	QJ 320
105	160	26	120	154	2900	3300	2	2	2	QJ 1021
	190	36	233	265	2500	2900	2,1	2	4,8	QJ 221
110	170	28	142	183	2700	3200	2	2	2,5	QJ 1022
	200	38	272	319	3800	4700	2,1	2	5,6	QJ 222
	240	50	377	479	3400	3900	3	2,5	12,5	QJ 322
120	180	28	145	195	2500	2900	2	2	2,65	QJ 1024
	215	40	293	364	3500	4100	2,1	2	6,95	QJ 224
	260	55	401	522	3000	3800	3	2,5	16	QJ 324
130	200	33	177	238	2100	2600	2	2	4,05	QJ 1026
	230	40	299	397	3200	4100	3	2,5	7,75	QJ 226
	280	58	443	601	2900	3400	4	3	19,5	QJ 326
140	210	22	118	162	1900	2500	1,1	1	2,6	305647
	210	33	185	264	1900	2500	2	2	4,3	QJ 1028
	250	42	336	467	3100	3600	3	2,5	9,85	QJ 228
	300	62	489	686	2700	3200	4	3	24	QJ 328
150	225	35	209	301	1800	2300	2,1	2	5,25	QJ 1030
	270	45	390	566	2900	3300	3	2,5	12,5	QJ 230
	320	65	518	756	2500	2900	4	3	29	QJ 330
160	240	38	241	350	1700	2100	2,1	2	6,45	QJ 1032
	290	48	440	662	2700	3100	3	2,5	15,5	QJ 232

Four point contact ball bearings

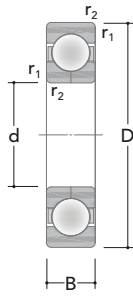

QJ

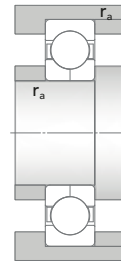

Main dimensions			Basic load ratings		Speed ratings		Dimensions		Mass	Designation
d	D	B	Dynamic C	Static C ₀	Reference	Limiting	r _{1,2min}	r _{amax}		
[mm]			[kN]		[rpm]		[mm]		[kg]	-
160	340	68	555	866	2300	2800	4	3	34,5	QJ 332
170	260	42	277	404	1600	2000	2,1	2	8,6	QJ 1034
	310	52	439	710	2500	2800	4	3	19,5	QJ 234
	360	72	638	1020	2100	2700	4	3	41,5	QJ 334
180	280	46	331	509	1500	1800	2,1	2	11	QJ 1036
	320	52	463	761	2300	2800	4	3	20,5	QJ 236
	380	75	663	1080	2100	2500	4	3	47,5	QJ 336
190	290	46	328	500	1500	1800	2,1	2	11,5	QJ 1038
	340	55	490	843	2100	2600	4	3	23,5	QJ 238
	400	78	681	1150	1600	2400	5	4	49	QJ 338
200	250	24	77,5	137	970	1200	1	1	2,5	305419
	310	51	380	616	1400	1700	2,1	2	15	QJ 1040
	360	58	528	913	1700	2400	4	3	28,5	QJ 240
	360	70	508	863	1200	1500	4	3	32,5	QJ 1240
220	270	24	107	192	1400	1700	1,5	1	3	305976
	340	56	429	736	1200	1400	3	2,5	19,5	QJ 1044
	400	65	536	979	1000	1300	4	3	39,5	QJ 244
	400	78	574	1000	1000	1300	4	3	45,5	QJ 1244
	460	88	760	1390	970	1200	5	4	78	QJ 344
240	360	56	435	772	1100	1400	3	2,5	21	QJ 1048
	440	72	635	1180	970	1200	4	3	53	QJ 248
	440	85	644	1200	970	1200	4	3	61	QJ 1248
260	360	46	382	709	1000	1300	2,1	2	15	QJ 1952
	400	65	522	996	960	1200	4	3	31,5	QJ 1052
	480	80	710	1420	870	1100	5	4	68	QJ 252
	480	90	724	1450	870	1000	5	4	78	QJ 1252
280	420	65	539	1040	920	1200	4	3	33,5	QJ 1056
	500	90	704	1450	860	1000	5	4	82	QJ 1256
300	460	74	629	1330	870	1100	4	3	47,5	QJ 1060
	540	98	814	1730	830	1000	5	4	105	QJ 1260
320	480	74	639	1390	810	1000	4	3	50	QJ 1064

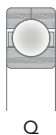

Main dimensions			Basic load ratings		Speed ratings		Dimensions		Mass	Designation
d	D	B	Dynamic C	Static C ₀	Reference	Limiting	r _{1,2min}	r _{amax}		
[mm]			[kN]		[rpm]		[mm]		[kg]	—
320	580	105	904	2030	780	930	5	4	130	QJ 1264
335	450	56	558	1210	820	1000	3	2,5	27	309941
340	520	82	762	1670	780	950	5	4	87,5	QJ 1068
	620	118	1030	2410	730	860	6	5	165	QJ 1268
360	540	82	764	1780	770	920	5	4	70,5	QJ 1072
	650	122	1080	2560	680	810	6	5	190	QJ 1272
380	560	82	794	1870	720	820	5	4	73,5	QJ 1076
	680	132	1120	2820	640	740	6	5	220	QJ 1276
400	600	90	871	2120	670	820	5	4	95,5	QJ 1080
	720	140	1260	3190	580	660	6	5	265	QJ 1280
420	560	65	618	1560	670	810	4	3	51	QJ 1984
	620	90	886	2250	640	770	5	4	99,5	QJ 1084
	760	150	1370	3670	530	640	7,5	6	315	QJ 1284
440	600	74	736	1870	640	770	4	3	65	QJ 1988
	650	94	973	2470	610	700	6	5	115	QJ 1088
	790	155	1360	3690	540	610	7,5	6	350	QJ 1288
460	680	100	1010	2600	580	660	6	5	130	QJ 1092
	830	165	1490	4240	510	580	7,5	6	415	QJ 1292
480	700	100	1010	2740	530	610	6	5	135	QJ 1096
	870	170	1620	4680	480	560	7,5	6	470	QJ 1296



Cylindrical roller bearings

Cylindrical roller bearings	71
Single row cylindrical roller bearings	71
Radial internal clearance	71
Misalignment	74
Minimum load	74
Single row full complement cylindrical roller bearing	75
Radial internal clearance	75
Misalignment	75
Minimum load	75
Designs and variants	76
Type NU	76
Type NUP	76
Type NJG	76
Type NCF	76
Type N	77
Type NJ	77
Type NJGL	77
Split type SCRBFIXED/LOOSE	77
Prefixes	78
Suffixes	78
Product tables	81
Double row cylindrical roller bearings	103
Double row full complement cylindrical roller bearing	103
Internal clearance	103
Axial displacement	103
Misalignment	103
Minimum load	104
Designs and variants	104
Type NNU	104
Type NNC-C (SL01)	104
Type NN	105

Split type 2ROW SCRB.....	105
Type NNF (SL04).....	105
Type NNCL-C (SL02).....	105
Type NNCF	106
Prefixes.....	107
Suffixes.....	107
Product tables.....	109
Multi row cylindrical roller bearings.....	125
Internal clearance.....	125
Minimum load.....	125
Designs and variants.....	126
Type AF2D/A2D.....	126
Type F2CII/EVO	126
Type Q2ACEVO.....	126
Type GB2DX.....	126
Type D2CII.....	127
Prefixes.....	129
Suffixes.....	129
Product tables.....	131

RKB
BEARING INDUSTRIES
SWITZERLAND

Cylindrical roller bearings

The cylindrical roller bearings (CRBs) manufactured by RKB are produced in many designs, dimensions and series, to withstand heavy radial loads and medium speeds, covering most of the requirements in a variety of standard and special industrial applications. All CRBs manufactured by RKB offers the highest load rating capacities, improved internal geometry, high quality materials and special heat treatments for superior performance. RKB CRBs are available with cylindrical or tapered bore in single, double or multi row configuration. Depending on application requirements, RKB Bainite Hardening Treatment (HB) and High Temperature Dimensional Stabilization (S) can be applied on bearing rings and rollers. The bearing dimensional and running accuracy conforms to ISO/ABMA/GOST specifications.



Single row cylindrical roller bearings

RKB offers a wide range of single row cylindrical roller bearing designs in normal or reinforced execution with increased performance in critical applications. Roller and raceway profiles are designed to attain optimized stress distribution while minimizing the edge effect, especially under critical conditions. The portfolio of RKB single row CRBs is finally enhanced by the high-capacity full complement bearings (cageless), which reach higher load carrying capacities within the same boundary dimensions.

Radial internal clearance

Single row cylindrical roller bearings are produced as standard with Normal radial clearance CN, but they are available with C2, C3, C4 and C5 radial clearance, in accordance with the ISO 5753:2009.

Bearings with special radial clearance different than ISO 5753:2009 can be manufactured on request. The radial internal clearance of cylindrical roller bearings with cylindrical bore can be found in **Tab. 1 page 72**. The radial internal clearance of cylindrical roller bearings with tapered bore can be found in **Tab. 2 page 73** and they are valid only for bearing unmounted and unloaded.

d [mm]		Radial internal clearance [μm]									
		C2		CN		C3		C4		C5	
over	incl.	min.	max.	min.	max.	min.	max.	min.	max.	min.	max.
-	10	0	25	20	45	35	60	50	75	-	-
10	24	0	25	20	45	35	60	50	75	65	90
24	30	0	25	20	45	35	60	50	75	70	95
30	40	5	30	25	50	45	70	60	85	80	105
40	50	5	35	30	60	50	80	70	100	95	125
50	65	10	40	40	70	60	90	80	110	110	140
65	80	10	45	40	75	65	100	90	125	130	165
80	100	15	50	50	85	75	110	105	140	155	190
100	120	15	55	50	90	85	125	125	165	180	220
120	140	15	60	60	105	100	145	145	190	200	245
140	160	20	70	70	120	115	165	165	215	225	275
160	180	25	75	75	125	120	170	170	220	250	300
180	200	35	90	90	145	140	195	195	250	275	330
200	225	45	105	105	165	160	220	220	280	305	365
225	250	45	110	110	175	170	235	235	300	330	395
250	280	55	125	125	195	190	260	260	330	370	440
280	315	55	130	130	205	200	275	275	350	410	485
315	355	65	145	145	225	225	305	305	385	455	535
355	400	100	190	190	280	280	370	370	460	510	600
400	450	110	210	210	310	310	410	410	510	565	665
450	500	110	220	220	330	330	440	440	550	625	735
500	560	120	240	240	360	360	480	480	600	-	-
560	630	140	260	260	380	380	500	500	620	-	-
630	710	145	285	285	425	425	565	565	705	-	-
710	800	150	310	310	470	470	630	630	790	-	-
800	900	180	350	350	520	520	690	690	860	-	-
900	1000	200	390	390	580	580	770	770	960	-	-
1000	1120	220	430	430	640	640	850	850	1060	-	-
1120	1250	230	470	470	710	710	950	950	1190	-	-
1250	1400	270	530	530	790	790	1050	1050	1310	-	-
1400	1600	330	610	610	890	890	1170	1170	1450	-	-
1600	1800	380	700	700	1020	1020	1340	1340	1660	-	-
1800	2000	400	760	760	1120	1120	1480	1480	1840	-	-

Tab. 1 - Radial internal clearance of cylindrical roller bearings with cylindrical bore

Single row cylindrical roller bearings

d [mm]		Radial internal clearance [μm]							
		C2		CN		C3		C4	
over	incl.	min.	max.	min.	max.	min.	max.	min.	max.
–	10	15	40	30	55	40	65	50	75
10	24	15	40	30	55	40	65	50	75
24	30	20	45	35	60	45	70	55	80
30	40	20	45	40	65	55	80	70	95
40	50	25	55	45	75	60	90	75	105
50	65	30	60	50	80	70	100	90	120
65	80	35	70	60	95	85	120	110	145
80	100	40	75	70	105	95	130	120	155
100	120	50	90	90	130	115	155	140	180
120	140	55	100	100	145	130	175	160	205
140	160	60	110	110	160	145	195	180	230
160	180	75	125	125	175	160	210	195	245
180	200	85	140	140	195	180	235	220	275
200	225	95	155	155	215	200	260	245	305
225	250	105	170	170	235	220	285	270	335
250	280	115	185	185	255	240	310	295	365
280	315	130	205	205	280	265	340	325	400
315	355	145	225	225	305	290	370	355	435
355	400	165	255	255	345	330	420	405	495
400	450	185	285	285	385	370	470	455	555
450	500	205	315	315	425	410	520	505	615
500	560	230	350	350	470	455	575	560	680
560	630	260	380	380	500	500	620	620	740
630	710	295	435	435	575	565	705	695	835
710	800	325	485	485	645	630	790	775	935
800	900	370	540	540	710	700	870	860	1 030
900	1 000	410	600	600	790	780	970	960	1 150
1 000	1 120	455	665	665	875	865	1 075	1 065	1 275
1 120	1 250	490	730	730	970	960	1 200	1 200	1 440
1 250	1 400	550	810	810	1 070	1 070	1 330	1 330	1 590
1 400	1 600	640	920	920	1 200	1 200	1 480	1 480	1 760
1 600	1 800	700	1 020	1 020	1 340	1 340	1 660	1 660	1 980
1 800	2 000	760	1 120	1 120	1 480	1 480	1 840	1 840	2 200

Tab. 2 - Radial internal clearance of cylindrical roller bearings with tapered bore

Misalignment

The permissible misalignment between the shaft and the seat of a single row cylindrical roller bearing is restricted to a few minutes of arc. In particular we can theoretically estimate:

- 4 minutes of arc for bearings in the 10, 12, 2, 3 and 4 series;
- 3 minutes of arc for bearings in the 20, 22 and 23 series.

These values are applied for the non-locating bearings, if the shaft and housing axes remain unchanged. Larger values of misalignment may be used, but with negative consequences regarding the bearing life.

When the bearings are used in locating position, the permissible misalignments have to be reduced since an axial load in the bearing rib may generate heavy wear or a crack of the rib.

Bearing type NUP and NJ with HJ angle ring have two ribs on the inner ring and two ribs on the outer ring with a relatively small axial displacement. For this reason it is not possible to apply the permissible misalignment values given in the guideline since an axial stress may be generated, causing a premature failure of the bearing. For additional information, please consult the RKB application engineering service.

Minimum load

A minimum radial load is requested for single row cylindrical roller bearings to allow the correct functioning, especially in critical working conditions like: high speed, high acceleration and sudden changes of rotating direction. In these operating conditions, a skidding between rollers and raceways can be generated by the inertial forces, influencing negatively the bearing life. Assuming a continuous operation, the minimum radial load can be estimated using the following formula:

$$\frac{F_{rm}}{C_{0r}} > 50$$

Where:

- F_{rm} minimum radial load, [kN];
- C_{0r} static load rating, [kN].

Usually, the minimum radial load is reached or surpassed by the weight of the components supported by the bearing together with the loads acting on it, otherwise supplementary radial load must be applied. In application where a starting up at a low temperature is planned or a lubricant with high viscosity is used, a greater minimum radial load is required.

Single row full complement cylindrical roller bearing

Radial internal clearance

Single row full complement cylindrical roller bearings are produced as standard with Normal radial internal clearance CN, but they are available with C2, C3, C4 and C5 radial clearance, in accordance with the ISO 5753:2009.

The radial internal clearance values are reported in the previous **Table1 pag.6** and **Table2 pag.7**, for cylindrical and tapered bore respectively, and they are valid only for bearing unmounted and unloaded.



Misalignment

The permissible misalignment between the shaft and the seat of a single row full complement cylindrical roller bearing is restricted to a few minutes of arc:

- 4 minutes of arc for bearings of the narrow dimensional series 18
- 3 minutes of arc for bearings of the wider dimensional series 22, 23, 28, 29 and 30

The above values can be used for the non-

locating bearings, if the shaft and housing axes remain unchanged. Larger values of misalignment may be used, but with negative consequences regarding the bearing life. For additional information, please consult the RKB application engineering service.

Minimum load

A minimum radial load is requested for a single row full complement cylindrical roller bearings to allow the correct functioning, especially in critical working conditions like: high speed, high acceleration and sudden changes of rotating direction. In these operating conditions, a sliding movement between rollers and raceways can take place by the inertial forces, influencing negatively the bearing life. Minimum radial load can be theoretically estimated using this formula:

$$\frac{F_{rm}}{C_{0r}} > 50$$

Where:

- F_{rm} minimum radial load, [kN];
- C_{0r} basic static load rating, [kN].

Usually, the minimum radial load is reached or surpassed by the weight of the components supported by the bearing together with the loads acting on it, otherwise supplementary radial load must be applied on the single row full complement cylindrical roller bearing. In application where a starting up at a low temperature is planned or a lubricant with high viscosity is used, a larger value of the minimum radial load is required.

Designs and variants

Type NU

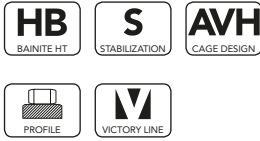
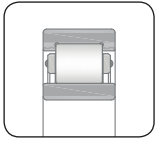

- Outer ring with two integral side ribs
- Ribless inner ring
- Two-piece machined brass cage guided on rollers (M) or outer ring (MA)
- Available with riveted or AVH cage also with lubrication grooves
- Optimized raceway geometry and roller profile
- To be used in non-locating position

Type NUP

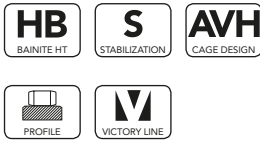
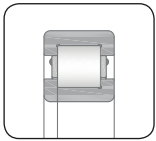

- Outer ring with two integral side ribs
- Inner ring with one integral side rib and one loose rib
- Two-piece machined brass cage guided on rollers (M) or outer ring (MA)
- Available with riveted or AVH cage also with lubrication grooves
- Optimized raceway geometry and roller profile
- Can be used in locating position

Type NJG

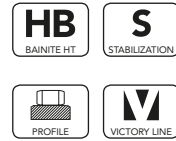
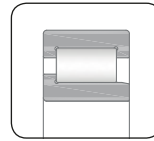

- Outer ring with two integral side ribs
- Inner ring with one integral side rib
- Full complement (cageless) separable design for increased carrying capacities
- Reduced maximum rotational speed compared to caged design
- Optimized raceway geometry and roller profile
- Can be used in one direction locating position

Type NCF

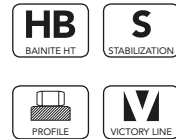
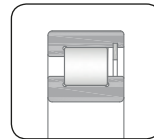

- Outer ring with one integral side rib and retaining ring
- Inner ring with two integral side ribs
- Full complement (cageless) design for increased load carrying capacities
- Reduced maximum rotational speed compared to caged design
- Optimized raceway geometry and roller profile
- Can be used in one direction locating position

Single row cylindrical roller bearings

Type N

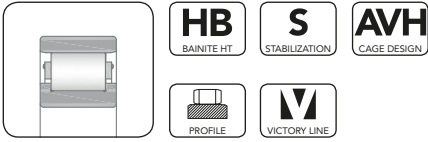

- Ribless outer ring
- Inner ring with two integral side ribs
- Two-piece machined brass cage guided on rollers (M) or inner ring (MB)
- Lubrication grooves in side faces of inner ring
- Available with riveted or AVH cage also with lubrication grooves
- Optimized raceway geometry and roller profile
- To be used in non-locating position

Type NJ

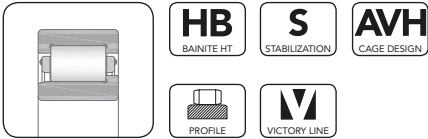

- Outer ring with two integral side ribs
- Inner ring with one integral side rib
- Two-piece machined brass cage guided on rollers (M) or outer ring (MA)
- Available with riveted or AVH cage also with lubrication grooves
- Optimized raceway geometry and roller profile
- Can be used in one direction locating position

Type NJGL

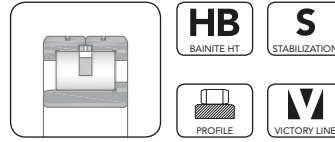

- Outer ring circumferentially split
- Inner ring with one integral side rib
- Lamellar brass cage design
- Designed to maintain high carrying capacities without compromising the rotational speed capability
- Optimized raceway geometry and roller profile

Split type SCRBFIXED/LOOSE

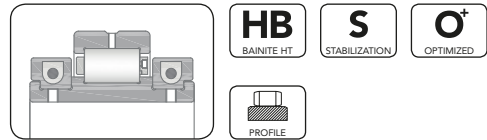

- Design used for medium and large size bearings
- Wider inner ring with integral side ribs
- Two-piece window-type
- Engineered for hard-to-reach positions (e.g. universal joint drive shaft supporting)
- Design for easy mounting, dismounting and maintenance to reduced machine downtime
- Available in locating and non-locating configuration
- Available in taylor-made dimension
- Optimized raceway geometry and roller profile

Prefixes

L	In a separable bearing: separate inner ring
R	In a separable bearing: outer ring with roller and cage assembly
HJ	Angle ring
SCRB	Out of standard split cylindrical roller bearing followed by drawing number

Suffixes
Internal Design

E	Optimized internal design with reinforced execution
EC	Optimized internal design for increased load ratings
SP	Special or non-standard bearing
ZB	Optimized roller profile for improved load distribution. It is not necessarily stated in the bearing code

Suffixes
Cage

MP1	One-piece solid HBSC1 brass cage guided on rollers
MP1A	One-piece solid HBSC1 brass cage guided on outer ring
MP1B	One-piece solid HBSC1 brass cage guided on inner ring
M	Machined brass cage guided on rollers
MA	Machined brass cage guided on outer ring
MAS	Machined brass cage guided on outer ring with lubrication grooves in the guiding surface
MB	Machined brass cage guided on inner ring
MBS	Machined brass cage guided on inner ring with lubrication grooves in the guiding surface
J	Pressed steel cage
TN or ATN	Molded polyamide cage (PA66) guided on rollers
TN9	Molded glass fiber-reinforced polyamide cage (PA66-GF25) guided on rollers
AVH	Machined brass cage with round or square integral rivets guided on outer ring (MA), inner ring (MB) or rollers (M)

Suffixes
Accuracy, clearance, running

R1	Radial internal clearance less than R2
R2	Radial internal clearance less than R3
R3	Standard radial internal clearance
R4	Radial internal clearance greater than R3
R5	Radial internal clearance greater than R4
ABEC1	Approximated to tolerance class P0
ABEC3	Approximated to tolerance class P6
ABEC5	Approximated to tolerance class P5
CS	Special radial internal clearance

Single row cylindrical roller bearings

Suffixes	Lubrication
W33	Annular groove and three lubrication holes in outer ring
W33X	Annular groove and more than three lubrication holes in outer ring

Suffixes	External design
K	Tapered bore, taper 1:12
K30	Tapered bore, taper 1:30
N	Snap ring groove in outer ring
N1	One locating slot in outer ring
N2	Two locating slots in outer ring

Single row cylindrical roller bearings

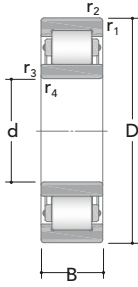

NU

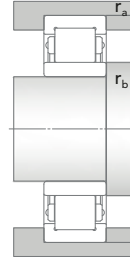

Main dimensions			Basic load ratings		Speed ratings		Dimensions				Mass	Designation		
d	D	B	Dynamic C	Static C ₀	Reference	Limiting	r _{1,2min}	r _{3,4min}	r _{amax}	r _{bmax}		Standard design	Alternative design	Angle ring
[mm]			[kN]		[rpm]		[mm]				[kg]	–	–	–
15	35	11	12,2	10,1	21400	22400	0,6	0,3	0,6	0,3	0,047	NU 202	N, NJ, NUP	–
17	40	12	16,7	14,1	18400	18400	0,6	0,3	0,6	0,3	0,068	NU 203	N, NJ, NUP	–
	40	16	23,1	21,4	18400	18800	0,6	0,3	0,6	0,3	0,087	NU 2203	N, NJ, NUP	–
	47	14	24,1	20,2	14600	17100	1	0,6	1	0,6	0,12	NU 303	N, NJ, NUP	–
20	47	14	24,5	21,9	15600	16000	1	0,6	1	0,6	0,11	NU 204	N, NJ, NUP	–
	47	18	28,9	27,0	15500	15800	1	0,6	1	0,6	0,14	NU 2204	N, NJ, NUP	–
	52	15	34,3	25,9	14500	15200	1,1	0,6	1	0,6	0,15	NU 304	N, NJ, NUP	HJ 304
	52	21	46,0	37,9	14500	15400	1,1	0,6	1	0,6	0,21	NU 2304	N, NJ, NUP	–
25	47	12	13,8	13,1	17500	15100	0,6	0,3	0,6	0,3	0,083	NU 1005	N, NJ, NUP	–
	52	15	28,0	26,7	13700	13400	1	0,6	1	0,6	0,13	NU 205	N, NJ, NUP	HJ 205
	52	18	33,2	33,7	13600	13700	1	0,6	1	0,6	0,16	NU 2205	N, NJ, NUP	HJ 2205
	62	17	44,9	36,4	11500	12900	1,1	1,1	1	1	0,23	NU 305	N, NJ, NUP	HJ 305
	62	24	62,5	54,3	11700	12700	1,1	1,1	1	1	0,34	NU 2305	N, NJ, NUP	HJ 2305
30	55	13	17,3	17,3	14500	13000	1	0,6	1	0,6	0,12	NU 1006	N, NJ, NUP	–
	62	16	42,6	36,1	12500	12100	1	0,6	1	0,6	0,2	NU 206	N, NJ, NUP	HJ 206
	62	20	53,0	48,2	12500	11700	1	0,6	1	0,6	0,26	NU 2206	N, NJ, NUP	–
	72	19	56,6	47,4	10600	10100	1,1	1,1	1	1	0,36	NU 306	N, NJ, NUP	HJ 306
	72	27	80,5	75,0	10600	10300	1,1	1,1	1	1	0,53	NU 2306	N, NJ, NUP	–
	90	23	58,1	52,5	8600	9100	1,5	1,5	1,5	1,5	0,75	NU 406	N, NJ, NUP	HJ 406
35	62	14	34,5	37,4	12500	10800	1	0,6	1	0,6	0,16	NU 1007	N, NJ, NUP	–
	72	17	54,0	47,7	10500	9880	1,1	0,6	1	0,6	0,29	NU 207	N, NJ, NUP	HJ 207
	72	23	67,9	62,2	10700	10000	1,1	0,6	1	0,6	0,4	NU 2207	N, NJ, NUP	–
	80	21	72,3	62,0	9100	9000	1,5	1,1	1,5	1	0,47	NU 307	N, NJ, NUP	HJ 307
	80	31	103	96,8	9100	9500	1,5	1,1	1,5	1	0,72	NU 2307	N, NJ, NUP	–
	100	25	74,5	68,4	7700	8100	1,5	1,5	1,5	1,5	1	NU 407	N, NJ, NUP	–
40	68	15	24,5	25,9	11700	15600	1	0,6	1	0,6	0,23	NU 1008	N, NJ, NUP	–
	80	18	60,7	52,9	9200	9200	1,1	1,1	1	1	0,37	NU 208	N, NJ, NUP	HJ 208
	80	23	78,7	74,7	9100	9000	1,1	1,1	1	1	0,49	NU 2208	N, NJ, NUP	HJ 2208
	90	23	89,8	77,7	7700	8000	1,5	1,5	1,5	1,5	0,65	NU 308	N, NJ, NUP	HJ 308
	90	33	126	118	7700	7900	1,5	1,5	1,5	1,5	0,94	NU 2308	N, NJ, NUP	–
	110	27	94,5	89,6	6800	7100	2	2	2	2	1,3	NU 408	N, NJ, NUP	–
45	75	16	42,9	51,6	10500	9370	1	0,6	1	0,6	0,25	NU 1009	N, NJ, NUP	–
	85	19	66,8	62,8	8600	8000	1,1	1,1	1	1	0,43	NU 209	N, NJ, NUP	HJ 209
	85	23	82,1	80,3	8600	7900	1,1	1,1	1	1	0,52	NU 2209	N, NJ, NUP	–

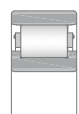

N

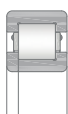

NUP



NJ



NGJL

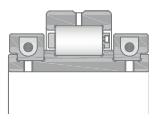

SCRBFIXED

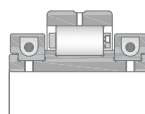

SCRBLOOSE

Main dimensions			Basic load ratings		Speed ratings		Dimensions				Mass	Designation		
d	D	B	Dynamic C	Static C ₀	Reference	Limiting	r _{1,2min}	r _{3,4min}	r _{amax}	r _{bmax}		Standard design	Alternative design	Angle ring
[mm]			[kN]		[rpm]		[mm]				[kg]	–	–	–
45	100	25	109	98,4	7300	7100	1,5	1,5	1,5	1,5	0,9	NU 309	N, NJ, NUP	HJ 309
	100	36	154	152	7200	7200	1,5	1,5	1,5	1,5	1,3	NU 2309	N, NJ, NUP	–
	120	29	103	101	6500	6200	2	2	2	2	1,65	NU 409	N, NJ, NUP	HJ 409
50	80	16	45,7	55,2	9200	8100	1	0,6	1	0,6	0,27	NU 1010	N, NJ, NUP	–
	90	20	70,9	69,1	8100	7700	1,1	1,1	1	1	0,48	NU 210	N, NJ, NUP	HJ 210
	90	23	87,0	87,7	8200	7400	1,1	1,1	1	1	0,56	NU 2210	N, NJ, NUP	–
	110	27	124	111	6500	6900	2	2	2	2	1,15	NU 310	N, NJ, NUP	HJ 310
	110	40	180	184	6400	6800	2	2	2	2	1,75	NU 2310	N, NJ, NUP	–
	130	31	126	125	5800	6000	2,1	2,1	2	2	2	2	NU 410	N, NJ, NUP
55	90	18	55,3	69,2	8200	7100	1,1	1	1	1	0,39	NU 1011	N, NJ, NUP	–
	100	21	93,0	94,5	7200	6800	1,5	1,1	1,5	1	0,66	NU 211	N, NJ, NUP	HJ 211
	100	25	110	117	7200	6800	1,5	1,1	1,5	1	0,79	NU 2211	N, NJ, NUP	HJ 2211
	120	29	153	143	5800	6000	2	2	2	2	1,45	NU 311	N, NJ, NUP	HJ 311
	120	43	223	228	5700	5700	2	2	2	2	2,2	NU 2311	N, NJ, NUP	HJ 2311
	140	33	139	139	5400	5300	2,1	2,1	2	2	2,5	NU 411	N, NJ, NUP	–
	60	95	18	36,2	43,5	7700	11300	1,1	1	1	1	0,5	NU 1012	N, NJ, NUP
110		22	106	101	6500	6200	1,5	1,5	1,5	1,5	0,8	NU 212	N, NJ, NUP	HJ 212
110		28	142	152	6400	6500	1,5	1,5	1,5	1,5	1,05	NU 2212	N, NJ, NUP	HJ 212
130		31	168	160	5400	5700	2,1	2,1	2	2	1,75	NU 312	N, NJ, NUP	HJ 312
130		46	254	261	5400	5500	2,1	2,1	2	2	2,75	NU 2312	N, NJ, NUP	HJ 2312
150		35	162	170	4800	4900	2,1	2,1	2	2	3	NU 412	N, NJ, NUP	–
65	100	18	61,1	81,0	7300	6400	1,1	1	1	1	0,45	NU 1013	N, NJ, NUP	–
	120	23	118	117	6100	5500	1,5	1,5	1,5	1,5	1,05	NU 213	N, NJ, NUP	HJ 213
	120	31	166	180	6100	5600	1,5	1,5	1,5	1,5	1,4	NU 2213	N, NJ, NUP	HJ 2213
	140	33	207	193	5100	5100	2,1	2,1	2	2	2,2	NU 313	N, NJ, NUP	HJ 313
	140	48	275	289	5100	5100	2,1	2,1	2	2	3,2	NU 2313	N, NJ, NUP	HJ 2313
	160	37	177	189	4600	4600	2,1	2,1	2	2	3,55	NU 413	N, NJ, NUP	HJ 413
70	110	20	74,9	91,9	6800	5900	1,1	1	1	1	0,62	NU 1014	N, NJ, NUP	HJ 1014
	125	24	132	135	5700	5400	1,5	1,5	1,5	1,5	1,15	NU 214	N, NJ, NUP	HJ 214
	125	31	176	191	5800	5300	1,5	1,5	1,5	1,5	1,5	NU 2214	N, NJ, NUP	HJ 2214
	150	35	227	224	4600	4600	2,1	2,1	2	2	2,7	NU 314	N, NJ, NUP	HJ 314
	150	51	307	323	4600	4800	2,1	2,1	2	2	3,95	NU 2314	N, NJ, NUP	HJ 2314
	180	42	224	237	4200	4300	3	3	2,5	2,5	5,35	NU 414	N, NJ, NUP	HJ 414
75	115	20	57,0	70,1	6500	8300	1,1	1	1	1	0,75	NU 1015	N, NJ, NUP	–
	130	25	144	153	5300	5000	1,5	1,5	1,5	1,5	1,25	NU 215	N, NJ, NUP	HJ 215

Single row cylindrical roller bearings

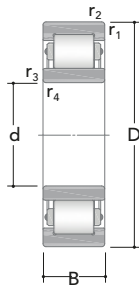

NU

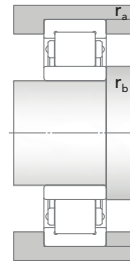

Main dimensions			Basic load ratings		Speed ratings		Dimensions				Mass	Designation		
d	D	B	Dynamic C	Static C ₀	Reference	Limiting	r _{1,2min}	r _{3,4min}	r _{amax}	r _{bmax}		Standard design	Alternative design	Angle ring
[mm]			[kN]		[rpm]		[mm]				[kg]	–	–	–
75	130	31	179	204	5300	5100	1,5	1,5	1,5	1,5	1,6	NU 2215	N, NJ, NUP	–
	160	37	274	264	4300	4500	2,1	2,1	2	2	3,3	NU 315	N, NJ, NUP	HJ 315
	160	55	367	394	4300	4500	2,1	2,1	2	2	4,8	NU 2315	N, NJ, NUP	HJ 2315
	190	45	257	275	3800	4000	3	3	2,5	2,5	6,2	NU 415	N, NJ, NUP	HJ 415
80	125	22	62,4	77,9	6100	5200	1,1	1	1	1	0,88	NU 1016	N, NJ, NUP	–
	140	26	154	163	5000	4600	2	2	2	2	1,55	NU 216	N, NJ, NUP	HJ 216
	140	33	204	243	5000	4700	2	2	2	2	2	NU 2216	N, NJ, NUP	HJ 216
	170	39	294	287	4200	4200	2,1	2,1	2	2	3,85	NU 316	N, NJ, NUP	HJ 316
	170	58	402	439	4100	4100	2,1	2,1	2	2	5,85	NU 2316	N, NJ, NUP	HJ 2316
	200	48	292	317	3600	3800	3	3	2,5	2,5	7,25	NU 416	N, NJ, NUP	HJ 416
85	130	22	65,5	84,8	5700	7600	1,1	1	1	1	1,05	NU 1017	N, NJ, NUP	–
	150	28	185	197	4600	4500	2	2	2	2	1,9	NU 217	N, NJ, NUP	HJ 217
	150	36	242	279	4600	4400	2	2	2	2	2,5	NU 2217	N, NJ, NUP	–
	180	41	327	329	3800	4100	3	3	2,5	2,5	4,65	NU 317	N, NJ, NUP	HJ 317
	180	60	444	483	3900	4100	3	3	2,5	2,5	6,85	NU 2317	N, NJ, NUP	HJ 2317
	210	52	309	335	3400	3700	4	4	3	3	8,7	NU 417	N, NJ, NUP	HJ 417
90	140	24	78,6	103	5400	6900	1,5	1,1	1,5	1	1,35	NU 1018	N, NJ, NUP	–
	160	30	200	218	4300	4100	2	2	2	2	2,3	NU 218	N, NJ, NUP	HJ 218
	160	40	270	313	4300	4100	2	2	2	2	3,15	NU 2218	N, NJ, NUP	HJ 2218
	190	43	355	354	3600	3700	3	3	2,5	2,5	5,25	NU 318	N, NJ, NUP	HJ 318
	190	64	489	534	3700	3700	3	3	2,5	2,5	8	NU 2318	N, NJ, NUP	HJ 2318
	225	54	370	408	3300	3400	4	4	3	3	10,5	NU 418	N, NJ, NUP	–
95	145	24	82,2	110	5100	6800	1,5	1,1	1,5	1	1,45	NU 1019	N, NJ, NUP	–
	170	32	246	264	4100	3900	2,1	2,1	2	2	2,85	NU 219	N, NJ, NUP	HJ 219
	170	43	318	371	4200	3900	2,1	2,1	2	2	3,8	NU 2219	N, NJ, NUP	–
	200	45	379	387	3400	3500	3	3	2,5	2,5	6,2	NU 319	N, NJ, NUP	HJ 319
	200	67	510	575	3400	3500	3	3	2,5	2,5	9,35	NU 2319	N, NJ, NUP	HJ 2319
	240	55	398	452	3000	3100	4	4	3	3	13,5	NU 419	N, NJ, NUP	–
100	140	20	80,3	121	4300	4500	1	1,1	1	1	1	NU 1920	N, NJ, NUP	–
	150	24	83,1	113	4800	6300	1,5	1,1	1,5	1	1,45	NU 1020	N, NJ, NUP	–
	150	24	83,7	112	4100	4200	1,1	1,5	1	1,5	1,45	NU 1020	N, NJ, NUP	–
	150	30	162	239	3400	3700	1,1	1,5	1	1,5	1,8	NU 2020	N, NJ, NUP	–
	165	52	292	448	2800	3000	1,1	2	1	2	4,4	NU 3120	N, NJ, NUP	–
	180	34	279	305	3900	3900	2,1	2,1	2	2	3,4	NU 220	N, NJ, NUP	HJ 220
	180	46	365	441	3800	3800	2,1	2,1	2	2	4,75	NU 2220	N, NJ, NUP	HJ 2220

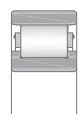

N



NGJL

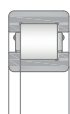

NUP

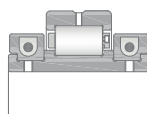

SCRBFIXED



NJ

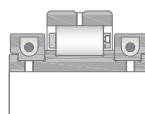

SCRBLOOSE

Main dimensions			Basic load ratings		Speed ratings		Dimensions				Mass	Designation		
d	D	B	Dynamic C	Static C ₀	Reference	Limiting	r _{1,2min}	r _{3,4min}	r _{amax}	r _{bmax}		Standard design	Alternative design	Angle ring
[mm]			[kN]		[rpm]		[mm]				[kg]	–	–	–
100	180	34/46	245	300	3100	3100	2,1	2,1	2	2	3,75	NUB 220	–	–
	180	46/96	250	337	3000	3100	2,1	2,1	2	2	6,7	313638	–	–
	180,075	60,325	402	581	2900	2900	2,6	2	2,5	2	7,1	319897	–	–
	215	47	440	440	3100	3100	3	3	2,5	2,5	7,45	NU 320	N, NJ, NUP	HJ 320
	215	73	656	727	3100	3100	3	3	2,5	2,5	12	NU 2320	N, NJ, NUP	HJ 2320
	250	58	441	517	2800	3000	4	4	3	3	15,5	NU 420	N, NJ, NUP	HJ 420
105	160	26	97,2	136	4600	6000	2	1,1	2	1	1,9	NU 1021	N, NJ, NUP	–
	190	36	293	313	3700	3700	2,1	2,1	2	2	3,95	NU 221	N, NJ, NUP	HJ 221
	225	49	486	491	3100	3100	3	3	2,5	2,5	8,55	NU 321	N, NJ, NUP	–
	260	60	488	561	2700	2800	4	4	3	3	17,5	NU 421	N, NJ, NUP	–
110	170	28	124	164	4300	6000	2	1,1	2	1	2,3	NU 1022	N, NJ, NUP	–
	200	38	328	365	3500	3300	2,1	2,1	2	2	4,7	NU 222	N, NJ, NUP	HJ 222
	200	53	431	520	3500	3300	2,1	2,1	2	2	6,7	NU 2222	N, NJ, NUP	–
	240	50	510	531	2800	2800	3	3	2,5	2,5	10,5	NU 322	N, NJ, NUP	HJ 322
	240	80	760	886	2900	2800	3	3	2,5	2,5	17	NU 2322	N, NJ, NUP	HJ 2322
	280	65	508	579	2500	2600	4	4	3	3	20,5	NU 422	N, NJ, NUP	HJ 422
	260,324	90,075	725	955	1900	2100	2,5	2,5	2,5	2,5	27,3	467062	–	–
120	165	22	108	170	5300	5400	0,6	1,1	0,6	1	1,4	NU 1924	N, NJ, NUP	–
	180	28	130	181	3200	3400	1,1	2	2	1	2,45	NU 1024	N, NJ, NUP	–
	180	36	221	349	2600	2800	1,1	2	2	1	3,1	NU 2024	N, NJ, NUP	–
	180	60/28	172	246	2700	2800	2	1,1	2	1	3,5	322052	–	–
	200	62	397	589	2300	2400	2	1	1	2	7,8	315516	–	–
	215	40	382	425	3300	3000	2,1	2,1	2	2	5,6	NU 224	N, NJ, NUP	HJ 224
	215	58	507	621	3300	3000	2,1	2,1	2	2	8,3	NU 2224	N, NJ, NUP	HJ 2224
	215	40/88	330	425	2300	2500	2,1	2,1	2	2	7,6	322927	–	–
	240	80	543	764	1900	2200	3,7	3	3,5	2,5	17,8	322870	–	–
	260	55	587	609	2600	2600	3	3	2,5	2,5	13	NU 324	N, NJ, NUP	HJ 324
	260	55/83	518	615	1800	2000	3	3	2,5	2,5	17	326067	–	HJ 2324
	310	72	623	733	2300	2300	5	5	4	4	27,5	NU 424	N, NJ, NUP	HJ 424
	310	72/89,12	629	732	1800	2000	5	5	4	4	33,8	465094	–	–
129,921	228,6	79,375	651	1010	1900	2200	5	4	2,5	3	14	322932	–	–
130	200	33	160	220	3100	3100	1,1	2	2	1	3,75	NU 1026	N, NJ, NUP	–
	200	42	285	431	2400	2600	1,1	2	2	1	4,6	NU 2026	N, NJ, NUP	–
	200	52	342	573	2500	2600	1,1	1	1	1	6,1	NU 3026	N, NJ, NUP	–
	200	60/33	213	309	2500	2700	2	1,1	2	1	5,95	322051	–	–
	220	62/73,5	399	552	1900	2200	2,1	2	2	2	9,6	442661	–	–

Single row cylindrical roller bearings

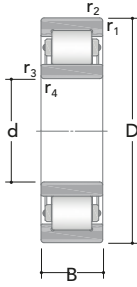

NU

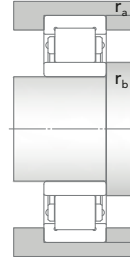

Main dimensions			Basic load ratings		Speed ratings		Dimensions				Mass	Designation		
d	D	B	Dynamic C	Static C ₀	Reference	Limiting	r _{1,2min}	r _{3,4min}	r _{amax}	r _{bmax}		Standard design	Alternative design	Angle ring
[mm]			[kN]		[rpm]		[mm]				[kg]	-	-	-
130	230	40	402	450	3100	2800	3	3	2,5	2,5	6,45	NU 226	N, NJ, NUP	HJ 226
	230	64	595	724	3100	2800	3	3	2,5	2,5	10	NU 2226	N, NJ, NUP	HJ 2226
	240	80	536	768	2100	2300	4	3	3	2,5	16,7	235013	-	-
	250	75	515	747	1800	1900	2,5	3	2	2,5	15	609341	-	-
	250	80	592	806	1800	2000	3,7	3	3,5	2,5	17,5	322880	-	-
	250	75/88	515	739	1800	2000	3	3	2,5	2,5	16	609342	-	-
	260	86	702	965	1800	2000	7,5	3	6	2,5	21,5	312733	-	-
	260	86/90,5	704	976	1800	2000	3	3	2,5	2,5	22	327260	-	-
	280	58	705	742	2300	2600	4	4	3	3	16	NU 326	N, NJ, NUP	HJ 326
	280	93	885	1230	2300	2600	4	4	3	3	30	NU 2326	N, NJ, NUP	HJ 2326
	281	58	606	740	1700	1800	4	4	3	3	19	319926	-	-
	340	78	820	994	1700	1800	5	5	4	4	36	NU 426	N, NJ, NUP	-
140	210	33	166	242	2800	2900	1,1	2	2	1	4	NU 1028	N, NJ, NUP	-
	210	42	303	488	2300	2500	1,1	2	2	1	4,9	NU 2028	N, NJ, NUP	-
	250	42	435	509	2700	2700	3	3	2,5	2,5	9,4	NU 228	N, NJ, NUP	HJ 228
	250	68	560	820	1900	2200	3	3	2,5	2,5	13,5	NU 2228	N, NJ, NUP	HJ 2228
	250	42/60	381	503	1900	2100	3	3	2,5	2,5	9,25	322883	-	-
	270	78	620	864	1700	1800	2,5	3	2,5	2,5	22	614073	-	-
	270	78/91	622	868	1700	1800	3	3	3,5	2,5	23,3	614074	-	-
	300	62	755	828	2300	2400	4	3	3	3	22	NU 328	N, NJ, NUP	HJ 328
	300	102	1020	1410	1700	1800	4	4	3	3	37	NU 2328	N, NJ, NUP	HJ 2328
	300	114,3	1090	1550	1700	1800	3	3	2,5	2,5	41,8	467063	-	-
	360	82	879	1060	1600	1600	5	5	4	4	47	NU 428	N, NJ, NUP	-
	149,969	320	65	795	1010	1600	1700	4	4	3	3	24,5	313268	-
150	225	35	189	273	2500	2600	1,5	2,1	2	1,5	4,85	NU 1030	N, NJ, NUP	-
	225	45	337	545	2100	2200	1,5	2,1	2	1,5	6	NU 2030	N, NJ, NUP	-
	225	56	399	707	2000	2400	1,5	1,1	1	1,5	7,9	NU 3030	N, NJ, NUP	-
	270	45	499	593	2400	2300	3	3	2,5	2,5	11,5	NU 230	N, NJ, NUP	HJ 230
	270	73	709	916	2500	2300	3	3	2,5	2,5	18,5	NU 2230	N, NJ, NUP	HJ 2230
	300	102	852	1230	1600	1700	4	4	3	3	35,5	314834	-	-
	320	65	754	961	1600	1600	4	4	3	3	28	NU 330	N, NJ, NUP	HJ 330
	320	108	1150	1610	1600	1700	4	4	3	3	45	NU 2330	N, NJ, NUP	-
	380	85	948	1160	1500	1600	5	5	4	4	53,5	NU 430	N, NJ, NUP	-
140	210	33	166	242	2800	2900	1,1	2	2	1	4	NU 1028	N, NJ, NUP	-
	210	42	303	488	2300	2500	1,1	2	2	1	4,9	NU 2028	N, NJ, NUP	-
	250	42	435	509	2700	2700	3	3	2,5	2,5	9,4	NU 228	N, NJ, NUP	HJ 228
	250	68	560	820	1900	2200	3	3	2,5	2,5	13,5	NU 2228	N, NJ, NUP	HJ 2228

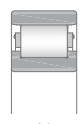

N

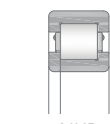

NUP

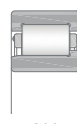

NJ

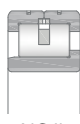

NGJL

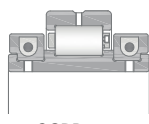

SCRBFIXED

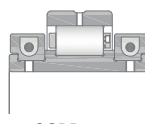

SCRBLOOSE

Main dimensions			Basic load ratings		Speed ratings		Dimensions				Mass	Designation		
d	D	B	Dynamic C	Static C ₀	Reference	Limiting	r _{1,2min}	r _{3,4min}	r _{amax}	r _{bmax}		Standard design	Alternative design	Angle ring
[mm]			[kN]		[rpm]		[mm]				[kg]	-	-	-
140	250	42/60	381	503	1900	2100	3	3	2,5	2,5	9,25	322883	-	-
	270	78	620	864	1700	1800	2,5	3	2,5	2,5	22	614073	-	-
	270	78/91	622	868	1700	1800	3	3	3,5	2,5	23,3	614074	-	-
	300	62	755	828	2300	2400	4	3	3	3	22	NU 328	N, NJ, NUP	HJ 328
	300	102	1020	1410	1700	1800	4	4	3	3	37	NU 2328	N, NJ, NUP	HJ 2328
	300	114,3	1090	1550	1700	1800	3	3	2,5	2,5	41,8	467063	-	-
	360	82	879	1060	1600	1600	5	5	4	4	47	NU 428	N, NJ, NUP	-
149,969	320	65	795	1010	1600	1700	4	4	3	3	24,5	313268	-	-
150	225	35	189	273	2500	2600	1,5	2,1	2	1,5	4,85	NU 1030	N, NJ, NUP	-
	225	45	337	545	2100	2200	1,5	2,1	2	1,5	6	NU 2030	N, NJ, NUP	-
	225	56	399	707	2000	2400	1,5	1,1	1	1,5	7,9	NU 3030	N, NJ, NUP	-
	270	45	499	593	2400	2300	3	3	2,5	2,5	11,5	NU 230	N, NJ, NUP	HJ 230
	270	73	709	916	2500	2300	3	3	2,5	2,5	18,5	NU 2230	N, NJ, NUP	HJ 2230
	300	102	852	1230	1600	1700	4	4	3	3	35,5	314834	-	-
	320	65	754	961	1600	1600	4	4	3	3	28	NU 330	N, NJ, NUP	HJ 330
	320	108	1150	1610	1600	1700	4	4	3	3	45	NU 2330	N, NJ, NUP	-
	380	85	948	1160	1500	1600	5	5	4	4	53,5	NU 430	N, NJ, NUP	-
160	240	38	223	323	2200	2400	1,5	2,1	2	1,5	5,95	NU 1032	N, NJ, NUP	HJ 1032
	240	48	405	663	1900	2200	1,5	2,1	2	1,5	7,9	NU 2032	N, NJ, NUP	-
	240	60	437	780	1900	2100	1,5	1	1	1,5	9,7	NU 3032	N, NJ, NUP	-
	290	48	571	670	2300	2200	3	3	2,5	2,5	14	NU 232	N, NJ, NUP	HJ 232
	290	80	792	1180	1700	1900	3	3	2,5	2,5	24	NU 2232	N, NJ, NUP	HJ 2232
	290	98/125	986	1430	1600	1600	3	3	2,5	2,5	31	320151	-	-
	300	84	705	1050	1600	1700	7,5	4	3	3	28	609099	-	-
	300	84/98	704	1050	1600	1600	4	4	3	3	30	609100	-	-
	340	68	967	1070	1400	1500	4	4	3	3	32,5	NU 332	N, NJ, NUP	HJ 332
	340	114	1270	1850	1400	1400	4	4	3	3	53	NU 2332	N, NJ, NUP	-
	165,1	279,4	61,912	602	892	1700	1800	4	4	3	3	23	322832	-
170	230	28	177	287	2300	2400	1,1	2	2	1	3,55	NU 1934	N, NJ, NUP	-
	260	42	266	395	2700	3700	2,1	2,1	2	2	8	NU 1034	N, NJ, NUP	HJ 1034
	260	42	265	394	2000	2300	2,1	2,1	2	2	7,9	NU 1034	N, NJ, NUP	-
	260	54	460	730	1800	2000	2,1	2,1	2	2	11	NU 2034	N, NJ, NUP	HJ 234
	310	52	592	807	1700	1800	4	4	3	3	19	NU 234	N, NJ, NUP	HJ 2234
	310	86	931	1400	1700	1800	4	4	3	3	30	NU 2234	N, NJ, NUP	-
	360	72	922	1170	1600	1800	4	3	3	3	37,5	NU 334	N, NJ, NUP	-
	360	120	1570	2190	1300	1400	4	4	3	3	63	NU 2334	N, NJ, NUP	-

Single row cylindrical roller bearings

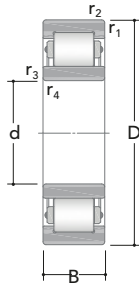

NU

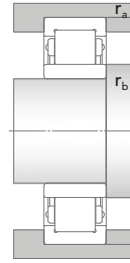

Main dimensions			Basic load ratings		Speed ratings		Dimensions				Mass	Designation		
d	D	B	Dynamic C	Static C ₀	Reference	Limiting	r _{1,2min}	r _{3,4min}	r _{amax}	r _{bmax}		Standard design	Alternative design	Angle ring
[mm]			[kN]		[rpm]		[mm]				[kg]	-	-	-
180	250	33	233	368	3600	3500	2	2	2	2	5,05	NU 1936	N, NJ, NUP	-
	250	42	255	440	2000	2300	2	2	2	2	6,7	NU 2936	N, NJ, NUP	-
	280	46	325	473	1900	2100	2,1	2,1	2	2	10,5	NU 1036	N, NJ, NUP	HJ 1036
	280	60	606	966	1700	1800	2,1	2,1	2	2	14	NU 2036	N, NJ, NUP	-
	280	74	672	1180	1700	1900	2,1	1	1	2	17	NU 3036	N, NJ, NUP	-
	320	52	613	847	1600	1700	4	4	3	3	19,5	NU 236	N, NJ, NUP	HJ 236
	320	75	740	1080	1600	1600	7,5	4	3	3	27,5	319641	-	-
	320	86	983	1480	1600	1600	4	4	3	3	31,5	NU 2236	N, NJ, NUP	-
	340	100	973	1470	1600	1700	4	4	3	3	43,5	314525	-	HJ 2236
	380	75	999	1270	1500	1800	4	3	3	3	44,5	NU 336	N, NJ, NUP	-
	380	126	1520	2260	1200	1300	4	4	3	3	72,5	NU 2336	N, NJ, NUP	-
	440	95	1200	1580	1200	1300	6	6	5	5	79	NU 436	N, NJ, NUP	-
	190	260	33	246	400	1900	2100	1,1	2	2	2	5,5	NU 1938	N, NJ, NUP
260		42	255	449	1900	2200	2	2	2	2	7	NU 2938	N, NJ, NUP	-
290		46	334	497	1900	2100	2,1	2,1	2	2	11	NU 1038	N, NJ, NUP	HJ 1038
290		60	622	1030	1700	1900	2,1	2,1	2	2	15	NU 2038	N, NJ, NUP	-
290		75	696	1230	1700	1800	1,7	2,1	1,5	2	18	NU 3038	N, NJ, NUP	-
340		55	677	962	1500	1500	4	4	3	3	23,5	NU 238	N, NJ, NUP	HJ 238
340		92	1060	1640	1500	1600	4	4	3	3	39	NU 2238	N, NJ, NUP	-
400		78	1110	1470	1400	1600	5	5	4	4	50	NU 338	N, NJ, NUP	HJ 338
400		132	1780	2490	1100	1200	5	5	4	4	82,5	NU 2338	N, NJ, NUP	-
200	250	30	179	341	2100	2400	1,5	1,5	1,5	1,5	3,55	NU 2840	N, NJ, NUP	-
	280	38	256	397	2000	2300	2,1	2,1	2	2	7,4	NU 1940	N, NJ, NUP	-
	280	48	321	576	1900	2100	2,1	2,1	2	2	9,5	NU 2940	N, NJ, NUP	-
	310	51	369	559	1800	2000	2,1	2,1	2	2	14	NU 1040	N, NJ, NUP	HJ 1040
	310	66	711	1200	1600	1600	2,1	2,1	2	2	19	NU 2040	N, NJ, NUP	-
	310	82	771	1390	1600	1700	1	2,1	1	2	23,5	NU 3040	N, NJ, NUP	-
	340	112	1150	1880	1300	1400	2	3	2	2,5	41	NU 3140	N, NJ, NUP	-
	360	58	747	1040	1400	1500	4	4	3	3	28,5	NU 240	N, NJ, NUP	HJ 240
	360	98	1190	1880	1400	1500	4	4	3	3	46	NU 2240	N, NJ, NUP	-
	360	128	1490	2440	1200	1300	4	4	3	3	59	NU 3240	N, NJ, NUP	-
	360	98/143	1180	1870	1400	1500	4	4	3	3	50	326518	-	-
	420	80	962	1290	1200	1300	5	5	4	4	56	NU 340	N, NJ, NUP	-
	420	138	1970	2790	1100	1200	5	5	4	4	96	NU 2340	N, NJ, NUP	-
	210	380	61	821	1160	1400	1500	5	5	4	4	32	463553	-
220	300	38	324	551	1800	1900	1,5	2,1	1,5	2	8,3	NU 1944	N, NJ, NUP	-
	300	38	273	465	1800	2000	4	2,1	3	2	8	246312	-	-

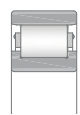

N

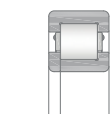

NUP



NJ

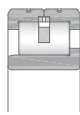

NGJL

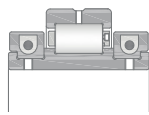

SCRBFIXED

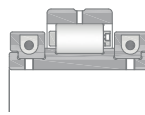

SCRBLOOSE

Main dimensions			Basic load ratings		Speed ratings		Dimensions				Mass	Designation		
d	D	B	Dynamic C	Static C ₀	Reference	Limiting	r _{1,2min}	r _{3,4min}	r _{amax}	r _{bmax}		Standard design	Alternative design	Angle ring
[mm]			[kN]		[rpm]		[mm]				[kg]	-	-	-
220	300	48	443	830	1800	2000	1,5	2,1	1,5	2	10	NU 2944	N, NJ, NUP	-
	340	56	479	726	1700	1900	3	3	2,5	2,5	18,5	NU 1044	N, NJ, NUP	HJ 1044
	340	72	858	1430	1400	1500	3	3	2,5	2,5	25	NU 2044	N, NJ, NUP	-
	340	90	912	1690	1400	1500	1,1	3	-	2,5	31	NU 3044	N, NJ, NUP	-
	350	83	820	1310	1200	1300	3	3	2,5	2,5	31,5	314591	-	-
	370	120	1270	2110	1100	1200	1,5	4	1,5	3	51,5	NU 3144	N, NJ, NUP	-
	400	65	746	1070	1400	1500	4	4	3	3	38,5	NU 244	N, NJ, NUP	-
	400	108	1520	2270	1200	1300	4	4	3	3	62,5	NU 2244	N, NJ, NUP	HJ 244
	460	88	1170	1610	1400	1400	5	5	4	4	72,5	NU 344	N, NJ, NUP	-
	460	145	2300	3410	1200	1800	5	5	4	4	124	NU 2344	N, NJ, NUP	-
220,586	320	45	379	623	1500	1800	3	3	2,5	2,5	12,3	411468	-	-
220,91	320	45	376	618	1700	1800	3	3	2,5	2,5	12,2	413585	-	-
229,954	370	100	1160	2090	1100	1200	3	3	2,5	2,5	44,5	475618	-	-
230	400	120	1620	2570	1200	1300	3	3	2,5	2,5	74	322380	-	-
234,848	320	38/46	360	601	1200	1300	2,5	2,1	2,5	2	11	320707	-	-
235,306	360	56/63	659	1000	1300	1400	2,5	2,5	2,5	2,5	22	320706	-	-
240	320	48	351	663	1700	1800	2,1	2,1	2	2	11,5	NU 2948	N, NJ, NUP	-
	360	56	505	789	1600	1600	3	3	2,5	2,5	20	NU 1048	N, NJ, NUP	HJ 1048
	360	72	870	1550	1300	1400	3	3	2,5	2,5	26,5	NU 2048	N, NJ, NUP	-
	360	92	985	1850	1300	1400	3	3	2,5	2,5	34	NU 3048	N, NJ, NUP	-
	400	128	1410	2400	1000	1100	1,1	3	1	2,5	64	NU 3148	N, NJ, NUP	-
	440	72	929	1350	1500	1800	4	4	3	3	51,5	NU 248	N, NJ, NUP	-
	440	120	1410	2330	1400	1800	4	4	3	3	84	NU 2248	N, NJ, NUP	-
	440	120	1520	2490	1100	1200	4	4	3	3	84	313221	-	-
	500	95	1410	1990	1200	1300	5	5	4	4	94,5	NU 348	N, NJ, NUP	HJ 348
	500	155	2510	3610	1100	1700	5	5	4	4	155	NU 2348	N, NJ, NUP	-
250	380	83	872	1470	1200	1300	3	3	2,5	2,5	35,5	314592	-	-
260	320	36	276	582	1600	1700	2	2	2	2	6,3	NU 2852	N, NJ, NUP	-
	340	35	340	607	1600	1600	2	2	2	2	8,7	312235	-	-
	340	38	339	618	1600	1700	4	2	3	2	9,3	246313	-	-
	360	46	456	802	1500	1600	2,1	1,5	2	2	14,5	NU 1952	N, NJ, NUP	-
	400	65	607	953	1400	1500	4	4	3	3	29,5	NU 1052	N, NJ, NUP	HJ 1052

Single row cylindrical roller bearings

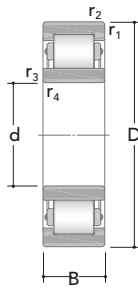

NU

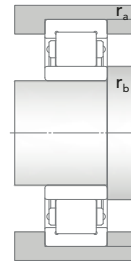

Main dimensions			Basic load ratings		Speed ratings		Dimensions				Mass	Designation		
d	D	B	Dynamic C	Static C ₀	Reference	Limiting	r _{1,2min}	r _{3,4min}	r _{amax}	r _{bmax}		Standard design	Alternative design	Angle ring
[mm]			[kN]		[rpm]		[mm]				[kg]	–	–	–
260	400	82	1140	2060	1100	1200	4	4	3	3	39	NU 2052	N, NJ, NUP	–
	400	104	1280	2310	1100	1200	4	4	3	3	48	NU 3052	N, NJ, NUP	–
	440	144	2020	3410	970	1100	4	4	3	3	98	NU 3152	N, NJ, NUP	–
	480	80	1140	1670	1300	1700	5	5	4	4	68,5	NU 252	N, NJ, NUP	HJ 252
	480	130	1730	2960	1200	1600	5	5	4	4	110	NU 2252	N, NJ, NUP	–
	540	102	1890	2680	1000	1500	6	6	5	5	125	NU 352	N, NJ, NUP	–
	540	165	3060	4410	860	910	6	6	5	5	190	NU 2352	N, NJ, NUP	–
280	350	42	362	742	1500	1600	2	1,1	2	2	9,6	NU 2856	N, NJ, NUP	–
	360	38	366	697	1400	1500	4	2	3	2	9,6	246314	–	–
	380	46	509	873	1400	1500	2,1	2,1	2	2	15,5	NU 1956	N, NJ, NUP	–
	380	60	742	1380	1400	1500	2,1	2,1	2	2	20,5	NU 2956	N, NJ, NUP	–
	420	65	644	1050	1300	1400	4	4	3	3	31,5	NU 1056	N, NJ, NUP	HJ 1056
	420	82	1200	2130	1000	1200	4	4	3	3	40	NU 2056	N, NJ, NUP	–
	420	65/82	645	1040	1300	1300	4	4	3	3	34	312961	–	–
	460	146	2210	3890	910	1000	5	5	4	4	105	NU 3156	N, NJ, NUP	–
	500	80	1140	1780	1300	1600	5	5	4	4	71,5	NU 256	N, NJ, NUP	–
	500	130	2120	3400	1100	1600	5	5	4	4	115	NU 2256	N, NJ, NUP	HJ 2256
	500	165,1	2820	4930	870	940	4	4	3	3	160	322312	–	–
580	175	2590	4220	950	1400	6	6	5	5	232	NU 2356	N, NJ, NUP	–	
284,9	474,9	152,4	2180	4370	920	1000	4	4	3	3	120	475620	–	–
287,6	440	72	1050	1700	950	1100	6,4	6,4	6	6	42	463551	–	–
300	380	38	347	674	1300	1400	2,1	1,5	2	1,5	10,5	NU 1860	N, NJ, NUP	–
	380	48	457	966	1300	1400	2,1	1,5	2	1,5	13,5	NU 2860	N, NJ, NUP	–
	420	56	676	1130	1200	1300	3	3	2,5	2,5	24,5	NU 1960	N, NJ, NUP	–
	420	72	961	1880	1200	1300	3	3	2,5	2,5	33	NU 29602	N, NJ, NUP	–
	460	74	824	1340	1400	1600	4	4	3	3	46,5	NU 1060	N, NJ, NUP	HJ 1060
300	460	95	1450	2730	950	1100	4	4	3	3	59,5	NU 2060	N, NJ, NUP	–
	460	118	1580	3010	950	1000	1,5	4	1,5	4	72	NU 3060	N, NJ, NUP	–
	540	85	1360	2100	1200	1500	5	5	4	4	88	NU 260	N, NJ, NUP	–
	540	140	2020	3410	1100	1400	5	5	4	4	145	NU 2260	N, NJ, NUP	–
	620	185	3860	5800	760	810	7,5	7,5	6	6	270	NU 2360	N, NJ, NUP	–
320	415	43	450	848	1200	1300	4	2,1	3	2	16,2	246315	–	–
	440	72	741	1490	1100	1200	3	3	2,5	2,5	34,5	314756	–	–
	480	74	845	1410	1300	1600	4	4	3	3	48,5	NU 1064	N, NJ, NUP	HJ 1064
	480	95	1400	2610	900	1000	4	4	3	3	62,5	NU 2064	N, NJ, NUP	–

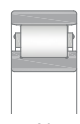

N

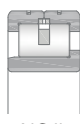

NGJL

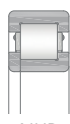

NUP

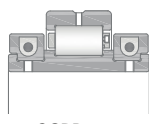

SCRBFIXED

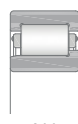

NJ

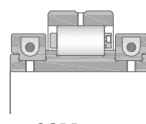

SCRBLOOSE

Main dimensions			Basic load ratings		Speed ratings		Dimensions				Mass	Designation		
d	D	B	Dynamic C	Static C ₀	Reference	Limiting	r _{1,2min}	r _{3,4min}	r _{amax}	r _{bmax}		Standard design	Alternative design	Angle ring
[mm]			[kN]		[rpm]		[mm]				[kg]	-	-	-
320	415	43	450	848	1200	1300	4	2,1	3	2	16,2	246315	-	-
	440	72	741	1490	1100	1200	3	3	2,5	2,5	34,5	314756	-	-
	480	74	845	1410	1300	1600	4	4	3	3	48,5	NU 1064	N, NJ, NUP	HJ 1064
	480	95	1400	2610	900	1000	4	4	3	3	62,5	NU 2064	N, NJ, NUP	-
	480	121	1760	3150	920	1000	4	4	3	3	75	NU 3064	N, NJ, NUP	-
	540	176	3070	5340	830	860	5	5	4	4	175	NU 3164	N, NJ, NUP	-
	580	92	1560	2410	1100	1300	5	5	4	4	115	NU 264	N, NJ, NUP	-
	580	150	3090	4990	970	1300	5	5	4	4	180	NU 2264	N, NJ, NUP	-
	620	165	3290	5270	810	840	6	6	5	5	235	319915	-	-
330	460	80/95	879	1700	900	1000	3	3	2,5	2,5	44,8	635316	-	-
330,15	558,8	141,29	2510	4440	870	910		5,1	5	5	155	475622	-	-
340	420	35	207	395	1100	1200	2,1	2,1	2	2	9,6	316197	-	-
	420	48	500	1100	1100	1200	2,1	2,1	2	2	15	NU 2868	N, NJ, NUP	-
	460	56	666	1180	1000	1100	3	3	2,5	2,5	27,5	NU 1968	N, NJ, NUP	-
	460	72	985	2010	1000	1100	3	3	2,5	2,5	37	NU 2968	N, NJ, NUP	-
	460,08	56	613	1100	1000	1100	3	3	2,5	2,5	27,5	313816	-	-
	520	82	1040	1740	1200	1400	5	5	4	4	65	NU 1068	N, NJ, NUP	HJ 1068
	520	133	2120	4080	870	920	5	5	4	4	106	NU 3068	N, NJ, NUP	-
	580	190	3080	5670	780	780	5	5	4	4	210	NU 3168	N, NJ, NUP	-
	620	165	2550	4490	970	1200	6	6	5	5	220	NU 2268	N, NJ, NUP	-
350	480	85	1010	2130	910	1000	4	4	3	3	48	612129	-	-
360	450	50	510	1010	1000	1100	4	4	3	3	18,7	246316	-	-
	540	82	1060	1810	1200	1300	5	5	4	4	67,5	NU 1072	N, NJ, NUP	HJ 1072
	540	106	1890	3590	860	910	5	5	4	4	88,5	NU 2072	N, NJ, NUP	-
	600	192	3330	5680	760	810	5	5	4	4	225	NU 3172	N, NJ, NUP	-
	650	95	1870	3000	820	840	6	6	5	5	150	NU 272	N, NJ, NUP	-
	650	170	2830	4860	900	1100	6	6	5	5	250	NU 2272	N, NJ, NUP	-
360	750	224	4900	8050	610	620	7,5	7,5	6	6	510	NU 2372	N, NJ, NUP	-
380	480	40	260	517	970	1100	2,1	2,1	2	2	15,5	316010	-	-
	480	46	524	1040	970	1000	2,1	2,1	2	2	23	NU 1876	N, NJ, NUP	-
	560	82	1100	1910	1100	1300	5	5	4	4	70	NU 1076	N, NJ, NUP	HJ 1076
	560	106	1910	3700	810	830	5	5	4	4	92,5	NU 2076	N, NJ, NUP	-
	560	135	2310	4710	810	840	5	5	4	4	115	NU 3076	N, NJ, NUP	-
	680	175	3810	6360	810	1000	6	6	5	5	275	NU 2276	N, NJ, NUP	-

Single row cylindrical roller bearings

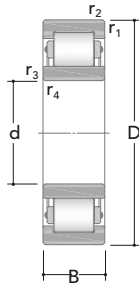

NU

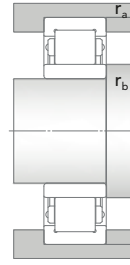

Main dimensions			Basic load ratings		Speed ratings		Dimensions				Mass	Designation		
d	D	B	Dynamic C	Static C ₀	Reference	Limiting	r _{1,2min}	r _{3,4min}	r _{amax}	r _{bmax}		Standard design	Alternative design	Angle ring
[mm]			[kN]		[rpm]		[mm]				[kg]	-	-	-
400	500	46	556	1170	950	1000	2,1	2,1	2	2	21	NU 1880	N, NJ, NUP	-
	540	65	918	1700	930	1000	4	4	3	3	41	NU 1980	N, NJ, NUP	-
	540	82	1340	2830	900	980	4	4	3	3	57	NU 2980	N, NJ, NUP	-
	600	90	1320	2300	1000	1200	5	5	4	4	91	NU 1080	N, NJ, NUP	HJ 1080
	600	118	2350	4660	760	820	5	5	4	4	120	NU 2080	N, NJ, NUP	-
	600	148	2700	5450	770	800	3	5	2,5	4	175	NU 3080	N, NJ, NUP	-
406,4	546,1	69,85	1070	2000	910	1000	5	5	4	4	46,5	322821	-	-
	603,25	82,55	1450	2490	720	760	5	5	4	4	84	322815	-	-
410	790	215	5960	9680	610	620	7,5	7,5	6	6	500	319896	-	-
	790	280	5320	9040	580	590	7,5	7,5	6	6	610	316931	-	-
420	520	40	287	608	920	1000	2,1	2,1	2	2	17,5	315932	-	-
	520	46	533	1100	910	980	2,1	1,5	2	1,5	20	NU 1884	N, NJ, NUP	-
	520	75	912	2220	870	910	2,1	1,5	2	1,5	33	NU 3884	N, NJ, NUP	-
	560	65	941	1760	850	910	4	4	3	3	48	NU 1984	N, NJ, NUP	-
	560	82	1170	2540	870	950	4	4	3	3	59	NU 2984	N, NJ, NUP	-
	620	90	1360	2400	1000	1200	5	5	4	4	94	NU 1084	N, NJ, NUP	HJ 1084
	620	118	2360	4700	710	750	5	5	4	4	125	NU 2084	N, NJ, NUP	-
	620	150	2410	5060	720	770	3	5	3	4	160	NU 3084	N, NJ, NUP	-
	700	224	4840	8990	600	640	6	6	5	5	380	NU 3184	N, NJ, NUP	-
	430	530	40	287	601	910	980	2,1	2,1	2	2	18,5	315834	-
440	540	40	284	600	860	940	2,1	2,1	2	2	18,5	316011	-	-
	540	60	786	1860	880	930	2,1	2,1	2	2	34	NU 2888	N, NJ, NUP	-
	600	74	1020	1980	860	900	4	4	3	3	64	NU 1988	N, NJ, NUP	-
	600	95	1660	3580	860	900	4	4	3	3	84	NU 2988	N, NJ, NUP	-
	650	94	1460	2630	970	1000	6	6	5	5	105	NU 1088	N, NJ, NUP	HJ 1088
	650	122	2450	4860	670	700	6	6	5	5	145	NU 2088	N, NJ, NUP	-
	650	157	2540	5360	660	690	4	6	4	5	180	NU 3088	N, NJ, NUP	-
	720	226	5010	9640	570	600	6	6	5	5	395	NU 3188	N, NJ, NUP	-
460	580	56	806	1690	850	910	3	3	2,5	2,5	37	NU 1892	N, NJ, NUP	-
	580	72	1030	2350	860	900	3	3	2,5	2,5	48	NU 2892	N, NJ, NUP	-
	680	100	1590	2810	900	1000	6	6	5	5	125	NU 1092	N, NJ, NUP	HJ 1092
	680	128	2700	5290	650	670	6	6	5	5	165	NU 2092	N, NJ, NUP	-
	680	163	3340	6350	640	690	6	6	5	5	210	NU 3092	N, NJ, NUP	-
	760	240	5150	9610	540	570	7,5	7,5	6	6	455	NU 3192	N, NJ, NUP	-

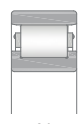

N



NGJL

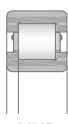

NUP

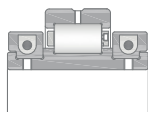

SCRBFIXED



NJ

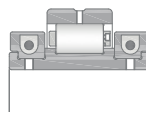

SCRBLOOSE

Main dimensions			Basic load ratings		Speed ratings		Dimensions				Mass	Designation		
d	D	B	Dynamic C	Static C ₀	Reference	Limiting	r _{1,2min}	r _{3,4min}	r _{amax}	r _{bmax}		Standard design	Alternative design	Angle ring
[mm]			[kN]		[rpm]		[mm]				[kg]	–	–	–
460	830	165	4060	6750	720	910	7,5	7,5	6	6	415	NU 1292	N, NJ, NUP	–
	830	212	4980	8500	660	930	7,5	7,5	6	6	530	NU 2292	N, NJ, NUP	–
469,9	596,9	57,15	766	1600	820	850	3	3	2,5	2,5	40,5	635010	–	–
	698,5	139,7	2960	5590	600	620	6	6	5	5	200	326097	–	–
470	920	246	7920	13190	460	450	9,5	9,5	8	8	750	320362	–	–
480	600	56	740	1610	820	820	3	3	2,5	2,5	39	NU 1896	N, NJ, NUP	–
	600	72	1060	2420	820	820	3	3	2,5	2,5	47,5	NU 2896	N, NJ, NUP	–
	650	78	1120	2220	760	810	5	5	4	4	75,5	NU 1996	N, NJ, NUP	–
	650	78	1290	2530	760	790	5	5	4	4	78	319164	–	–
	700	100	1620	2960	870	1000	6	6	5	5	130	NU 1096	N, NJ, NUP	HJ 1096
	700	128	2780	5510	600	630	6	6	5	5	170	NU 2096	N, NJ, NUP	–
	790	248	5750	10780	510	530	7,5	7,5	6	6	500	NU 3196	N, NJ, NUP	–
500	620	45	387	827	770	800	2,1	2,1	2	2	29	316198	–	–
	620	56	798	1720	780	800	3	3	2,5	2,5	39	NU 18/500	N, NJ, NUP	–
	670	78	1160	2310	710	770	5	5	4	4	79	NU 19/500	N, NJ, NUP	–
	670	128	2270	5130	660	690	5	5	4	4	130	NU 39/500	N, NJ, NUP	–
	720	100	1670	3040	860	750	6	6	5	5	135	NU 10/500	N, NJ, NUP	HJ 10/500
	720	128	2860	5840	600	640	6	6	5	5	180	NU 20/500	N, NJ, NUP	–
	720	167	3870	7950	600	620	6	6	5	5	225	NU 30/500	N, NJ, NUP	–
	830	264	6290	11850	480	510	7,5	7,5	6	6	595	NU 31/500	N, NJ, NUP	–
	920	185	5140	8360	630	780	7,5	7,5	6	6	585	NU 12/500	N, NJ, NUP	–
	530	650	45	405	890	720	730	3	3	2,5	2,5	30	315835	–
650		72	1130	2720	720	740	3	3	2,1	2,1	52	NU 28/530	N, NJ, NUP	–
710		106	2280	4950	670	730	5	5	4	4	120	NU 29/530	N, NJ, NUP	–
780		112	2230	4030	770	860	6	6	5	5	190	NU 10/530	N, NJ, NUP	–
780		145	3660	7340	640	830	6	6	5	5	255	NU 20/530	N, NJ, NUP	–
780		185	3990	8620	540	550	3	6	3	5	310	NU 30/530	N, NJ, NUP	–
870		272	6450	12470	460	480	4	7,5	3	6	680	NU 31/530	N, NJ, NUP	–
560		680	45	416	940	660	730	3	3	2,5	2,5	31,5	316053	–
	680	56	784	1820	680	710	3	3	2,5	2,5	44,5	NU 18/5606	N, NJ, NUP	–
	750	85	1610	3230	640	650	5	5	4	4	110	NU 19/560	N, NJ, NUP	–
	820	115	2240	4210	730	860	6	6	5	5	210	NU 10/560	N, NJ, NUP	HJ 10/560
	820	150	3680	7560	610	820	6	6	5	5	290	NU 20/560	N, NJ, NUP	–
	1030	206	7010	11000	530	690	9,5	9,5	8	8	805	NU 12/560	N, NJ, NUP	–

Single row cylindrical roller bearings

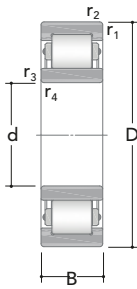

NU

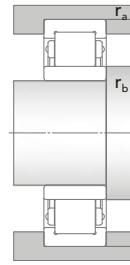

Main dimensions			Basic load ratings		Speed ratings		Dimensions				Mass	Designation		
d	D	B	Dynamic C	Static C ₀	Reference	Limiting	r _{1,2min}	r _{3,4min}	r _{amax}	r _{bmax}		Standard design	Alternative design	Angle ring
[mm]			[kN]		[rpm]		[mm]				[kg]	–	–	–
571,5	711,2	120,65	2400	6190	510	520	5	5	4	4	115	474795	–	–
600	730	52	452	1010	640	660	3	3	2,5	2,5	41	315836	–	–
	730	60	866	2000	630	650	3	3	2,5	2,5	50,5	NU 18/600	N, NJ, NUP	–
	800	90	1850	3790	600	630	5	5	4	4	130	NU 19/600	N, NJ, NUP	–
	800	118	2850	6520	600	640	5	5	4	4	165	NUP 29/600	N, NJ, NUP	–
	870	118	2640	5010	680	760	6	6	5	5	245	NU 10/600	N, NJ, NUP	HJ 10/600
	870	155	4030	7880	580	760	6	6	5	5	325	NU 20/600	N, NJ, NUP	–
	870	200	5170	10780	480	510	6	6	5	5	415	NU 30/600	N, NJ, NUP	–
	1090	155	5430	9790	460	630	9,5	9,5	8	8	710	NU 2/600	N, NJ, NUP	–
630	780	56	581	1270	590	630	4	4	3	3	55	315933	–	–
	780	88	1520	3850	600	630	4	4	3	3	100	NU 28/630	N, NJ, NUP	–
	780	112	2130	5650	540	560	4	4	3	3	120	NU 38/630	N, NJ, NUP	–
	850	100	2170	4350	570	590	6	6	5	5	165	NU 19/630	N, NJ, NUP	–
	850	128	3170	7130	580	570	6	6	5	5	220	NU 29/630	N, NJ, NUP	–
	920	128	3290	6110	610	720	7,5	7,5	6	6	285	NU 10/630	N, NJ, NUP	–
	920	170	4590	9420	540	720	7,5	7,5	6	6	400	NU 20/630	N, NJ, NUP	–
	920	212	6230	14120	430	440	7,5	7,5	6	6	490	NU 30/630	N, NJ, NUP	–
	1150	230	8350	13470	430	580	12	12	10	10	1110	NU 12/630	N, NJ, NUP	–
640	790	56	583	1260	580	570	4	4	3	3	56	315837	–	–
660,4	863,6	107,95	3000	6450	540	550	5	5	4	4	177	464777	–	–
670	820	56	603	1360	540	560	3	3	2,5	2,5	60	316012	–	–
	820	69	1180	2750	540	570	4	4	3	3	84,5	NU 18/670	N, NJ, NUP	–
	900	103	2240	4660	500	540	6	6	5	5	195	NU 19/670	N, NJ, NUP	–
	980	136	3620	6730	570	660	7,5	7,5	6	6	350	NU 10/670	N, NJ, NUP	–
	980	180	5230	10780	480	680	7,5	7,5	6	6	480	NU 20/670	N, NJ, NUP	–
	980	230	6660	14730	410	410	4	7,5	3	6	595	NU 30/670	N, NJ, NUP	–
673,1	838,2	117,475	2890	7160	510	520	5	5	4	4	160	316912	–	–
710	870	74	1390	3280	500	540	4	4	3	3	97,5	NU 18/710	N, NJ, NUP	–
	870	95	1870	4930	510	540	4	4	3	3	130	NU 28/710	N, NJ, NUP	–
	950	140	3660	8200	480	510	6	6	5	5	295	NU 29/710	N, NJ, NUP	–
	1030	140	4530	8400	540	610	7,5	7,5	6	6	415	NU 10/710	N, NJ, NUP	–
	1030	185	5800	11840	450	600	7,5	7,5	6	6	540	NU 20/710	N, NJ, NUP	–
720	880	62	683	1540	510	530	4	4	3	3	74,5	315799	–	–

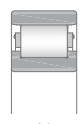

N



NGJL

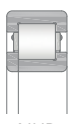

NUP

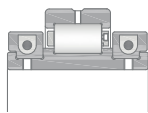

SCRBFIXED



NJ

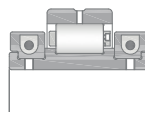

SCRBLOOSE

Main dimensions			Basic load ratings		Speed ratings		Dimensions				Mass	Designation		
d	D	B	Dynamic C	Static C ₀	Reference	Limiting	r _{1,2min}	r _{3,4min}	r _{amax}	r _{bmax}		Standard design	Alternative design	Angle ring
[mm]			[kN]		[rpm]		[mm]				[kg]	–	–	–
750	920	78	1430	3390	480	490	5	5	4	4	110	NU 18/750	N, NJ, NUP	–
	1000	112	2620	5500	460	470	6	6	5	5	255	319166	–	–
	1090	150	4540	8720	410	570	7,5	7,5	6	6	490	NU 10/750	N, NJ, NUP	–
	1090	195	6080	12570	410	570	7,5	7,5	6	6	635	NU 20/750	N, NJ, NUP	–
800	980	82	1670	4090	430	450	5	5	4	4	145	NU 18/800	N, NJ, NUP	–
	1150	155	5380	10490	320	340	7,5	7,5	6	6	560	NU 10/800	N, NJ, NUP	–
	1150	200	6800	14400	380	520	7,5	7,5	6	6	715	NU 20/800	N, NJ, NUP	–
820	990	72	839	1930	430	440	5	5	4	4	100	315800	–	–
850	1030	74	901	2080	–	–	5	5	4	4	115	316200	–	–
	1030	106	2050	5940	–	–	5	5	4	4	190	NU 28/850	N, NJ, NUP	–
	1120	118	3080	6920	–	–	6	6	5	5	330	NU 19/850	N, NJ, NUP	–
	1120	155	4500	10990	–	–	6	6	5	5	430	NU 29/850	N, NJ, NUP	–
900	1090	85	1920	4810	–	–	5	5	4	4	170	NU 18/900	N, NJ, NUP	–
	1090	112	2600	7150	–	–	5	5	4	4	235	NU 28/900	N, NJ, NUP	–
	1180	122	4040	8700	–	–	6	6	5	5	380	NU 19/900	N, NJ, NUP	–
	1180	165	5590	13860	–	–	6	6	5	5	560	NU 29/900	N, NJ, NUP	–
950	1150	90	1300	3040	–	–	5	5	4	4	170	315869	–	–
	1250	175	5610	13750	–	–	7,5	7,5	6	6	745	NU 29/950	N, NJ, NUP	–
1000	1220	100	2530	6490	–	–	6	6	5	5	265	NU 18/1000	N, NJ, NUP	–
	1220	128	3570	9890	–	–	6	6	5	5	350	NU 28/1000	N, NJ, NUP	–
	1220	100/128	2570	6510	–	–	6	6	5	5	287	NUB 18/1000	N, NJ, NUP	–
	1320	185	6870	17070	–	–	7,5	7,5	6	6	700	NU 29/1000	N, NJ, NUP	–
1030	1250	100	1460	3440	–	–	6	6	5	5	225	319579	–	–
1060	1280	100	1450	3390	–	–	6	6	5	5	230	316789	–	–
	1280	128	3480	10220	–	–	6	6	5	5	360	NU 28/1060	N, NJ, NUP	–
	1400	195	7050	17260	–	–	7,5	7,5	6	6	870	NU 29/1060	N, NJ, NUP	–
	1400	250	8900	23880	–	–	7,5	7,5	6	6	1070	NU 39/1060	N, NJ, NUP	–
	1500	325	12650	32280	–	–	9,5	9,5	8	8	1900	NU 30/1060	N, NJ, NUP	–
1120	1360	104	1600	3720	–	–	6	6	5	5	285	316201	–	–
	1360	106	3290	8620	–	–	6	6	5	5	335	NU 18/1120	N, NJ, NUP	–
	1580	345	15340	38490	–	–	9,5	9,5	8	8	2150	NU 30/1120	N, NJ, NUP	–

Single row cylindrical roller bearings

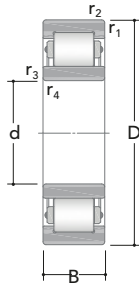

NU

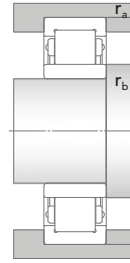

Main dimensions			Basic load ratings		Speed ratings		Dimensions				Mass	Designation		
d	D	B	Dynamic C	Static C ₀	Reference	Limiting	r _{1,2min}	r _{3,4min}	r _{amax}	r _{bmax}		Standard design	Alternative design	Angle ring
[mm]			[kN]		[rpm]		[mm]				[kg]	-	-	-
1180	1420	106	2940	7730	-	-	6	6	5	5	350	NU 18/1180	N, NJ, NUP	-
	1540	206	8750	21500	-	-	7,5	7,5	6	6	1050	NU 29/1180	N, NJ, NUP	-
	1540	272	10770	28470	-	-	7,5	7,5	6	6	1400	NU 39/1180	N, NJ, NUP	-
1250	1500	106	1670	4080	-	-	6	6	5	5	330	315913	-	-
	1750	290	12400	30460	-	-	9,5	9,5	8	8	2320	NU 20/1250	N, NJ, NUP	-
1320	1600	122	3710	9880	-	-	6	6	5	5	530	NU 18/1320	N, NJ, NUP	-
	1720	230	11020	30090	-	-	7,5	7,5	6	6	1500	NU 29/1320	N, NJ, NUP	-
	1720	300	12830	33400	-	-	7,5	7,5	6	6	1900	NU 39/1320	N, NJ, NUP	-
	1850	400	21080	54780	-	-	12	12	10	10	3550	NU 30/1320	N, NJ, NUP	-
1400	1700	175	6380	18250	-	-	7,5	7,5	6	6	860	NU 28/1400	N, NJ, NUP	-
1500	1820	140	3180	7950	-	-	7,5	7,5	6	6	665	319301	-	-
1700	2060	160	3610	9040	-	-	7,5	7,5	6	6	925	319286	-	-
1900	2300	175	8360	24620	-	-	9,5	9,5	8	8	1480	NU 18/1900	N, NJ, NUP	-

Single row full complement cylindrical roller bearings

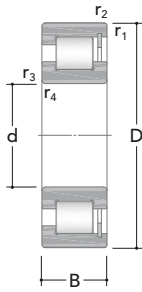

NCF

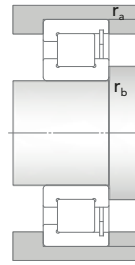

Main dimensions			Basic load ratings		Speed ratings		Dimensions				Mass	Designation
d	D	B	Dynamic C	Static C ₀	Reference	Limiting	r _{1,2min}	r _{3,4min}	r _{amax}	r _{bmax}		
[mm]			[kN]		[rpm]		[mm]				[kg]	–
20	42	16	27,3	28,3	8200	8400	0,6	0,3	0,6	0,3	0,11	NCF 3004
25	47	16	30,9	35,4	6700	7700	0,6	0,3	0,6	0,3	0,12	NCF 3005
	62	24	66,7	67,8	4300	4600	1,1	–	1	–	0,38	NJG 2305
30	55	19	38,5	43,2	5800	6400	1	0,3	1	0,3	0,2	NCF 3006
	72	27	81,2	85,2	3800	3900	1,1	–	1	–	0,56	NJG 2306
35	62	20	46,9	55,4	5100	5500	1	0,3	1	0,3	0,26	NCF 3007
	80	31	106	113	3200	3500	1,5	–	1,5	–	0,75	NJG 2307
40	68	21	55,4	69,4	4600	5000	1	0,3	1	0,3	0,31	NCF 3008
	90	33	139	153	2800	2900	1,5	–	1,5	–	1	NJG 2308
45	75	23	58,1	76,5	4100	4500	1	0,3	1	0,3	0,4	NCF 3009
	100	36	165	192	2700	2800	1,5	–	1,5	–	1,45	NJG 2309
50	80	23	73,5	97,2	3800	4300	1	0,3	1	0,3	0,43	NCF 3010
55	90	26	101	138	3300	3500	1,1	0,6	1	0,6	0,64	NCF 3011
	120	43	224	255	2100	2400	2	–	2	–	2,3	NJG 2311
60	85	16	53,5	78,6	3400	3700	1	0,6	1	0,5	0,29	NCF 2912
	95	26	103	145	3200	3400	1,1	0,6	1	0,5	0,69	NCF 3012
65	90	16	56,7	87,3	3100	3300	1	0,6	1	0,5	0,31	NCF 2913
	100	26	109	161	2900	3100	1,1	0,6	1	0,5	0,73	NCF 3013
	140	48	295	357	1800	2000	2,1	–	2	–	3,55	NJG 2313
70	100	19	74,2	116	2900	3200	1	0,6	1	0,5	0,49	NCF 2914
	110	30	123	171	2600	2900	1,1	0,6	1	0,5	1	NCF 3014
	150	51	327	393	1700	1800	2,1	–	2	–	4,4	NJG 2314
75	105	19	76,3	124	2700	3000	1	0,6	1	0,5	0,52	NCF 2915
	115	30	129	189	2500	2700	1,1	1,1	1	1	1,05	NCF 3015
	160	55	386	478	1500	1600	2,1	–	2	–	5,35	NJG 2315
80	110	19	78,9	130	2500	2900	1	0,6	1	0,5	0,55	NCF 2916
	125	34	161	227	2300	2500	1,1	0,6	1	0,5	1,45	NCF 3016
	170	58	442	562	1400	1600	2,1	–	2	–	6,4	NJG 2316

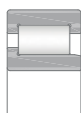

NJG

Main dimensions			Basic load ratings		Speed ratings		Dimensions				Mass	Designation
d	D	B	Dynamic C	Static C ₀	Reference	Limiting	r _{1,2min}	r _{3,4min}	r _{amax}	r _{bmax}		
[mm]			[kN]		[rpm]		[mm]				[kg]	–
85	120	22	99,0	163	2500	2600	1,1	1	1	1	0,81	NCF 2917
	130	34	166	233	2300	2400	1,1	0,6	1	0,5	1,5	NCF 3017
	180	60	467	617	1300	1500	3	–	2,5	–	7,4	NJG 2317
90	125	22	102	176	2300	2500	1,1	1	1	1	0,84	NCF 2918
	140	37	193	278	2100	2400	1,5	1	1,5	1	1,95	NCF 3018
	190	64	517	663	1300	1400	3	–	2,5	–	8,75	NJG 2318
100	140	24	125	198	2100	2200	1,1	1	1	1	1,15	NCF 2920
	150	37	203	307	1900	2100	1,5	1	1,5	1	2,15	NCF 3020
	180	46	366	521	830	1500	2,1	2,1	2	2	5,1	NCF 2220
	215	73	659	862	1100	1200	3	–	2,5	–	13	NJG 2320
110	150	24	131	219	1800	2000	1,1	1	1	1	1,25	NCF 2922
	170	45	266	394	1700	1800	2	1	2	1	3,5	NCF 3022
	200	53	423	595	720	1300	2,1	2,1	2	2	7,15	NCF 2222
	240	80	839	1050	1000	1100	3	–	2,5	–	17,5	NJG 2322
120	165	27	167	290	1700	1800	1,1	1	1	1	1,75	NCF 2924
	180	46	284	436	1600	1700	2	1	2	1	3,8	NCF 3024
	215	58	492	729	1300	1400	2,1	2,1	2	2	9,05	NCF 2224
	260	86	915	1230	960	1000	3	–	2,5	–	22,5	NJG 2324
130	180	30	199	360	1500	1700	1,5	1,1	1,5	1	2,35	NCF 2926
	200	52	400	618	1400	1600	2	1	2	1	5,8	NCF 3026
	230	64	590	868	650	1100	3	3	2,5	2,5	11	NCF 2226
	280	93	1030	1410	910	1000	4	–	3	–	28	NJG 2326
140	190	30	212	384	1400	1500	1,5	1,1	1,5	1	2,4	NCF 2928
	190	30	215	390	670	1200	1,5	1,1	1,5	1	2,4	NCF 2928
	210	53	430	679	1300	1500	2	1	2	1	6,1	NCF 3028
	250	68	670	1000	1100	1200	3	3	2,5	2,5	14,5	NCF 2228
	300	102	1180	1570	810	950	4	–	3	–	35,5	NJG 2328
150	190	20	104	199	670	1200	1,1	1	1	1	1,3	NCF 1830
	190	24	141	282	670	1200	1,1	1	1	1	1,7	NCF 2830
	210	36	284	486	1300	1400	2	1,1	2	1	3,75	NCF 2930
	225	56	443	709	1200	1300	2,1	1,1	2	1	7,5	NCF 3030
	270	73	774	1160	1000	1200	3	3	2,5	2,5	18,5	NCF 2230
	320	108	1390	1890	770	860	4	–	3	–	42,5	NJG 2330

Single row full complement cylindrical roller bearings

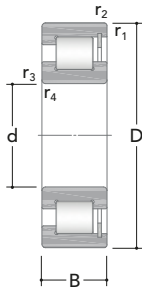

NCF

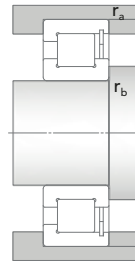

Main dimensions			Basic load ratings		Speed ratings		Dimensions				Mass	Designation
d	D	B	Dynamic C	Static C ₀	Reference	Limiting	r _{1,2min}	r _{3,4min}	r _{amax}	r _{bmax}		
[mm]			[kN]		[rpm]		[mm]				[kg]	–
160	200	20	110	210	640	1200	1,1	1	1	1	1,45	NCF 1832
	200	24	144	301	640	1100	1,1	1	1	1	1,65	NCF 2832
	220	36	297	524	1200	1300	2	1,1	2	1	4	NCF 2932
	240	60	492	784	1100	1200	2,1	1,1	2	1	9,1	NCF 3032
	290	80	965	1480	930	1000	3	3	2,5	2,5	23	NCF 2232
170	215	27	190	376	610	1000	1,1	1	1	1	2,3	NCF 2834
	230	36	304	553	1100	1200	2	1,1	2	1	4,3	NCF 2934
	240	30	269	439	580	990	2,7	2,7	2,5	2,5	4,1	316900
	260	67	649	1040	1000	1100	2,1	1,1	2	1	12,5	NCF 3034
	310	86	1050	1660	870	930	4	4	3	3	28,5	NCF 2234
	360	120	1700	2420	680	740	4	–	3	–	59,5	NJG 2334
180	225	22	142	271	580	990	1,1	1	1	1	1,95	NCF 1836
	225	27	193	397	570	1000	1,1	1	1	1	2,6	NCF 2836
	250	42	380	682	1000	1100	2	1,1	2	1	6,2	NCF 2936
	280	74	760	1220	1000	1100	2,1	2,1	2	2	16,5	NCF 3036
	320	86	1080	1720	480	800	4	4	3	3	29,5	NCF 2236
	380	126	1830	2620	640	660	4	–	3	–	69,5	NJG 2336
190	240	24	166	315	540	900	1,5	1,1	1,5	1	2,45	NCF 1838
	240	30	220	461	540	930	1,5	1,1	1,5	1	3,1	NCF 2838
	260	42	431	779	1000	1100	2	1,1	2	1	6,5	NCF 2938
	290	75	770	1270	970	1000	2,1	2,1	2	2	17	NCF 3038
	340	92	1190	1920	460	770	4	4	3	3	36	NCF 2238
	400	132	2090	2990	600	680	5	–	4	–	80	NJG 2338
200	250	24	172	330	1000	1100	1,5	1,1	1,5	1	2,6	NCF 1840
	250	30	227	473	540	910	1,5	1,1	1,5	1	2,6	NCF 2840
	280	48	514	950	970	1000	2,1	1,5	2	1,5	9,1	NCF 2940
	310	82	887	1500	920	990	2,1	2,1	2	2	22,5	NCF 3040
	360	98	1360	2230	430	730	4	4	3	3	43,5	NCF 2240
	420	138	2230	3190	570	620	5	–	4	–	92	NJG 2340
220	270	24	176	362	970	1000	1,5	1,1	1,5	1	2,85	NCF 1844
	270	30	234	523	510	830	1,5	1,1	1,5	1	3,9	NCF 2844
	300	48	531	1040	920	1000	2,1	1,5	2	1,5	9,9	NCF 2944
	340	90	1040	1770	820	950	3	3	2,5	2,5	29,5	NCF 3044
	400	108	1770	2690	670	720	4	4	3	3	58	NCF 2244
	460	145	2630	3700	510	550	5	–	4	–	111	NJG 2344

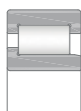

NJG

Main dimensions			Basic load ratings		Speed ratings		Dimensions				Mass	Designation
d	D	B	Dynamic C	Static C ₀	Reference	Limiting	r _{1,2min}	r _{3,4min}	r _{amax}	r _{bmax}		
[mm]			[kN]		[rpm]		[mm]				[kg]	–
240	300	28	253	502	860	950	2	1,1	2	1	4,4	NCF 1848
	300	36	329	709	460	740	2	1,1	2	1	5,7	NCF 2848
	320	48	563	1130	820	910	2,1	1,5	2	1,5	10,5	NCF 2948
	360	92	1110	1950	770	860	3	3	2,5	2,5	32	NCF 3048
	500	155	2740	3850	480	530	5	–	4	–	147	NJG 2348
260	320	28	264	548	770	820	2	1,1	2	1	4,75	NCF 1852
	320	36	344	778	410	670	2	1,1	2	1	6,2	NCF 2852
	360	60	715	1410	730	780	2,1	1,5	2	1,5	18,5	NCF 2952
	400	104	1480	2530	680	740	4	4	3	3	46,5	NCF 3052
	540	165	3480	4970	410	440	6	–	5	–	177	NJG 2352
540	206	4160	6240	140	260	6	6	5	5	220	NCF 3352	
280	350	33	331	695	720	790	2	1,1	2	1	7,1	NCF 1856
	350	42	435	984	380	640	2	1,1	2	1	9	NCF 2856
	380	60	849	1720	670	760	2,1	1,5	2	1,5	19,5	NCF 2956
	420	106	1500	2620	650	720	4	4	3	3	50	NCF 3056
300	380	38	405	849	640	700	2,1	1,5	2	1,5	10	NCF 1860
	380	48	555	1230	340	550	2,1	1,5	2	1,5	12	NCF 2860
	420	72	1070	2150	640	680	3	3	2,5	2,5	31	NCF 2960
	460	118	1840	3190	570	630	4	4	3	3	69	NCF 3060
320	400	38	426	890	600	660	2,1	1,5	2	1,5	10,5	NCF 1864
	400	48	569	1300	320	540	2,1	1,5	2	1,5	13,5	NCF 2864
	440	72	1110	2320	580	620	3	3	2,5	2,5	33	NCF 2964
	480	121	1900	3420	540	580	4	4	3	3	74,5	NCF 3064
340	420	38	436	947	580	640	2,1	1,5	2	1,5	11	NCF 1868
	460	72	1140	2470	540	590	3	3	2,5	2,5	35	NCF 2968
	520	133	2300	4100	510	570	5	5	4	4	100	NCF 3068
360	440	38	386	883	540	570	2,1	1,5	2	1,5	11,5	NCF 1872
	440	48	606	1440	290	480	2,1	1,5	2	1,5	15	NCF 2872
	480	72	1190	2570	510	560	3	3	2,5	2,5	36,5	NCF 2972
	540	134	2350	4220	480	520	5	5	4	4	105	NCF 3072
380	480	46	607	1270	500	560	2,1	1,5	2	1,5	19,5	NCF 1876
	480	60	868	2050	270	440	2,1	1,5	2	1,5	25	NCF 2876
	520	82	1510	3190	480	520	4	4	3	3	52	NCF 2976
	560	135	2640	5040	460	510	5	5	4	4	110	NCF 3076

Single row full complement cylindrical roller bearings

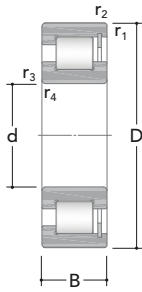

NCF

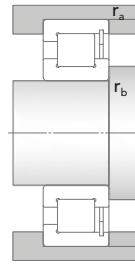

Main dimensions			Basic load ratings		Speed ratings		Dimensions				Mass	Designation
d	D	B	Dynamic C	Static C ₀	Reference	Limiting	r _{1,2min}	r _{3,4min}	r _{amax}	r _{bmax}		
[mm]			[kN]		[rpm]		[mm]				[kg]	–
400	500	46	613	1320	480	540	2,1	1,5	2	1,5	20,5	NCF 1880
	500	60	884	2130	250	420	2,1	1,5	2	1,5	26,5	NCF 2880
	540	82	1580	3380	460	500	4	4	3	3	54,5	NCF 2980
	600	148	2850	5450	440	460	5	5	4	4	145	NCF 3080
420	520	46	643	1400	460	500	2,1	1,5	2	1,5	20,5	NCF 1884
	520	60	921	2250	230	390	2,1	1,5	2	1,5	28	NCF 2884
	560	82	1580	3530	430	460	4	4	3	3	57	NCF 2984
	620	150	2960	5690	410	440	5	5	4	4	150	NCF 3084
440	540	46	655	1430	430	480	2,1	1,5	2	1,5	22	NCF 1888
	540	60	1030	2690	430	470	2,1	1,5	2	1,5	30	NCF 2888
	600	95	1950	4310	410	450	4	4	3	3	80	NCF 2988
	650	157	3650	7250	180	330	6	6	5	5	175	NCF 3088
460	580	56	883	1950	190	350	3	3	2,5	2,5	34	NCF 1892
	580	72	1250	3010	410	450	3	3	2,5	2,5	44	NCF 2892
	620	95	1980	4480	380	420	4	4	3	3	83	NCF 2992
	680	163	3590	6840	360	410	6	6	5	5	195	NCF 3092
480	600	56	910	2020	390	410	3	3	2,5	2,5	35,5	NCF 1896
	600	72	1290	3110	380	420	3	3	2,5	2,5	46	NCF 2896
	650	100	2200	4850	360	410	5	5	4	4	93	NCF 2996
	700	165	3590	7060	340	370	6	6	5	5	205	NCF 3096
500	620	56	919	2080	370	400	3	3	2,5	2,5	35,5	NCF 18/500
	620	72	1280	3330	370	390	3	3	2,5	2,5	48	NCF 28/500
	670	100	2270	4990	360	390	5	5	4	4	100	NCF 29/500
	720	167	3650	7350	340	370	6	6	5	5	215	NCF 30/500
530	650	56	957	2230	350	380	3	3	2,5	2,5	38,5	NCF 18/530
	650	72	1350	3440	340	370	3	3	2,5	2,5	49,5	NCF 28/530
	710	106	2610	5880	330	350	5	5	4	4	120	NCF 29/530
	780	185	5100	10560	310	330	6	6	5	5	300	NCF 30/530
560	680	56	983	2340	320	350	3	3	2,5	2,5	40,5	NCF 18/560
	680	72	1380	3580	320	360	3	3	2,5	2,5	54	NCF 28/560
	750	112	2970	6600	300	340	5	5	4	4	140	NCF 29/560
	820	195	5630	11640	290	330	6	6	5	5	345	NCF 30/560
600	730	60	1020	2520	300	340	3	3	2,5	2,5	51,5	NCF 18/600
	730	78	1530	4250	310	340	3	3	2,5	2,5	67,5	NCF 28/600

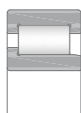

NJG

Main dimensions			Basic load ratings		Speed ratings		Dimensions				Mass	Designation
d	D	B	Dynamic C	Static C ₀	Reference	Limiting	r _{1,2min}	r _{3,4min}	r _{amax}	r _{bmax}		
[mm]			[kN]		[rpm]		[mm]				[kg]	-
600	800	118	3100	6980	280	310	5	5	4	4	170	NCF 29/600
630	780	69	1200	2880	280	300	4	4	3	3	72,5	NCF 18/630
	780	88	1800	4930	290	290	4	4	3	3	92,5	NCF 28/630
	850	128	3610	8530	270	270	6	6	5	5	205	NCF 29/630
670	820	69	1250	3140	260	280	4	4	3	3	76,5	NCF 18/670
	820	88	1860	5260	260	290	4	4	3	3	98	NCF 28/670
	900	136	3800	8850	250	270	6	6	5	5	245	NCF 29/670
710	870	74	1480	3690	250	270	4	4	3	3	92,5	NCF 18/710
	870	95	2270	6200	250	270	4	4	3	3	115	NCF 28/710
	950	140	4120	9920	230	250	6	6	5	5	275	NCF 29/710
750	920	78	1790	4410	230	250	5	5	4	4	110	NCF 18/750
	920	100	2540	6840	230	250	5	5	4	4	138	NCF 28/750
	1000	145	4360	10580	210	240	6	6	5	5	315	NCF 29/750
800	980	82	1860	4700	210	240	5	5	4	4	126	NCF 18/800
	980	106	2650	7450	210	230	5	5	4	4	165	NCF 28/800
	1060	150	4810	11900	190	220	6	6	5	5	359	NCF 29/800
850	1030	82	1980	5130	190	210	5	5	4	4	131	NCF 18/850
	1030	106	2740	7920	190	220	5	5	4	4	175	NCF 28/850
	1120	155	5040	12630	180	190	6	6	5	5	406	NCF 29/850
900	1090	85	2150	5660	180	200	5	5	4	4	154	NCF 18/900
	1090	112	3090	8970	180	190	5	5	4	4	208	NCF 28/900
	1180	165	5730	14520	160	180	6	6	5	5	472	NCF 29/900
950	1150	90	2350	6240	160	180	5	5	4	4	185	NCF 18/950
	1150	118	3330	9670	160	190	5	5	4	4	240	NCF 28/950
	1250	175	6510	16090	150	160	7,5	7,5	6	6	565	NCF 29/950
1000	1220	100	2830	7420	150	170	6	6	5	5	230	NCF 18/1000
	1220	128	3990	11460	150	160	6	6	5	5	310	NCF 28/1000
	1320	185	7190	18270	140	150	7,5	7,5	6	6	680	NCF 29/1000
1120	1360	106	3610	9500	120	140	6	6	5	5	298	NCF 18/1120

Double row cylindrical roller bearings

With a wide range of executions of double row cylindrical roller bearings, RKB is able to fulfil any requirement in demanding applications such as large size gearboxes, machine tools, grinding mills and crushers.

To ensure superior performance, RKB double row cylindrical roller bearings are manufactured from high quality special steels, heat treated in optimized automatic lines.

With improved internal geometry and profile, double row cylindrical roller bearings can withstand high radial loads within a narrow cross section.



Double row full complement cylindrical roller bearing

Internal clearance

Double row full complement cylindrical roller bearings are produced as standard with Normal radial internal clearance CN, but they are also available with C2, C3, and C4 radial internal clearance, in accordance with the ISO 5753:2009.

The radial internal clearance values are reported in the **Tab. 1 page 72** and **Tab. 2 page 73** and they are valid only for bearing unmounted and unloaded. The axial internal clearance of NNC and NNCF, which can axially locate the shaft in both directions, is in the range of 0.1 to 0.2 mm for all sizes.



Axial displacement

NNCL and NNCF bearing can accommodate axial displacement between shaft and housing within certain limits.

As a consequence of the fact that the axial displacement takes between the inner ring and outer ring and not between the inner ring and shaft and outer ring and housing, there is no additional friction during the bearing rotation.

Misalignment

Any misalignment between shaft and seat of the double row full complement cylindrical roller bearing creates a moment load inside the bearing. The bearing life will be obviously affected.

Minimum load

A minimum radial load is requested for a double row full complement cylindrical roller bearings to allow the correct functioning, especially in critical working conditions like: high speed, high acceleration and sudden changes of rotating direction. In these operating conditions, a skidding between the rollers and raceways can be generated by the inertial forces, influencing negatively the bearing life. Minimum radial load can be theoretically estimated using the following formula:

$$\frac{F_{rm}}{C_{0r}} > 50$$

Where:

- F_{rm} minimum radial load, [kN];
- C_{0r} basic static load rating, [kN] .

Usually, the minimum radial load is reached or surpassed by the weight of the components supported by the bearing together with the loads acting on it, otherwise supplementary radial load must be applied on the double row full complement cylindrical roller bearing. In application where a starting up at a low temperature is planned or a lubricant with high viscosity is used, a larger minimum radial load is required.

Designs and variants

Type NNU

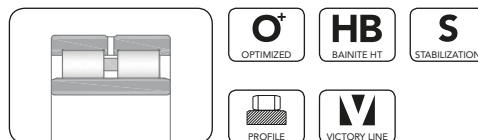

- Outer ring with three integral ribs
- Ribless inner ring
- One-piece double pronged machined brass or steel cage
- Annular groove and lubrication holes in outer ring
- Optimized raceway geometry and roller profile
- Available with cylindrical and tapered bore
- Available with locating slots in outer ring, lubrication holes in inner ring, lubrication grooves in side faces of inner and outer rings
- Available with steel pin type cage and pierced roller design

Type NNC-C (SL01)

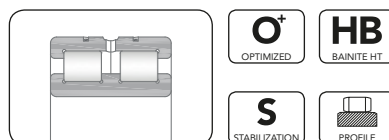

- Split outer ring with two integral ribs, clamped with a retaining ring
- Inner ring with three integral ribs
- Full complement (cageless) design for increased load carrying capacities
- Reduced maximum rotational speed compared to caged design
- Annular groove and lubrication holes in outer ring
- Optimized raceway geometry and roller profile
- Can be used in locating position

Double row cylindrical roller bearings

Type NN

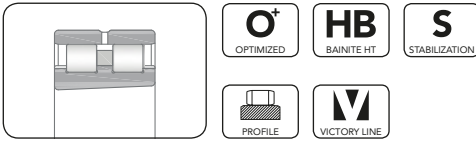

- Ribless outer ring
- Inner ring with three integral ribs
- One-piece double pronged machined brass cage
- Annular groove and lubrication holes in outer ring
- Optimized raceway geometry and roller profile
- Available with tapered and cylindrical bore
- Available with steel pin type cage and pierced roller design

Split type 2ROW SCRIB

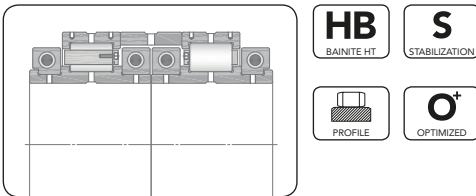

- Design used for medium and large size bearings
- Two wider inner ring with integral side ribs
- Two-piece window-type for each bearing row
- Engineered for hard-to-reach positions (e.g. universal joint drive shaft supporting)
- Design for easy mounting, dismounting and maintenance to reduced machine downtime
- Available in locating and non-locating configuration
- Available in taylor-made dimension
- Optimized raceway geometry and roller profile

Type NNF (SL04)

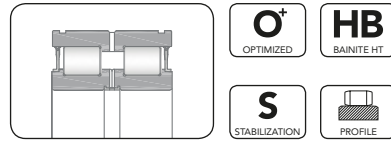

- Outer ring with one central integral rib
- Split inner ring with three integral ribs, clamped with a retaining ring
- Full complement (cageless) design for increased load carrying capacities
- Reduced maximum rotational speed
- Annular groove and lubrication holes in outer and inner ring
- Optimized raceway geometry and roller profile
- Integrated rubber seals on both bearing sides to avoid contamination
- Available filled with grease
- Can be used in locating position

Type NNCL-C (SL02)

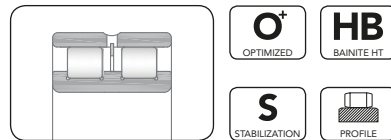

- Ribless outer ring
- Inner ring with three integral ribs
- Full complement (cageless) design for increased load carrying capacities
- Reduced maximum rotational speed compared to caged design
- Annular groove and lubrication holes in outer ring
- Separating ring between the two rows of rollers
- Optimized raceway geometry and roller profile
- Can be used in locating position

Type NNCF

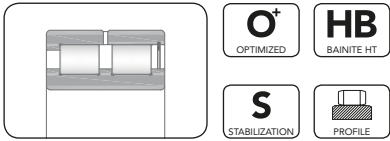

- Outer ring with one integral side rib and retaining ring
- Inner ring with three integral ribs
- Full complement (cageless) design for increased load carrying capacities
- Reduced maximum rotational speed compared to caged design
- Optimized raceway geometry and roller profile
- Can be used in one direction locating position
- Available with annular groove and lubrication holes in outer or inner ring

Double row cylindrical roller bearings

Prefixes

L	In a separable bearing: separate inner ring
R	In a separable bearing: outer ring with roller and cage assembly
2CRB	Out of standard double row cylindrical roller bearing followed by drawing number
WRE	Snap ring. The number immediately following the WRE gives the snap ring outer diameter in mm
SCRB	Out of standard double row cylindrical roller bearing followed by drawing number

Suffixes

Internal Design

DA	Modified snap ring grooves in outer ring and two-piece inner ring held together by retaining ring
ADA	Modified snap ring grooves in outer ring and two-piece inner ring held together by retaining ring
OD	Special outer diameter. The number immediately following the OD gives the outer diameter in mm
B	Special bearing width. The number immediately following the B gives the width in mm
SP	Special or non-standard bearing
ZB	Optimized roller profile for improved load distribution. It is not necessarily stated in the bearing code

Suffixes

Cage

M	Machined brass cage guided on rolling elements
MA	Machined brass cage guided on outer ring
MF	Machined steel cage
AVH	Machined brass cage with round or square integral rivets guided on outer ring (MA), inner ring (MB) or rollers (M)
V	Full complement of rolling elements (without cage)

Suffixes

Lubrication

G	Helical groove in inner ring bore (not necessarily stated)
ISR3	Annular groove and three lubrication holes in inner ring
W33	Annular groove and three lubrication holes in outer ring
W33X	Annular groove and more than three lubrication holes in outer ring
W77X	Annular groove and more than three plugged lubrication holes in outer ring
W	Lubrication grooves in the side faces of inner and outer rings (not necessarily stated)
WI	Lubrication grooves in the side face of inner ring (not necessarily stated)
WO	Lubrication grooves in the side face of outer ring (not necessarily stated)

Suffixes	External design
P	Contact seal on one side (3194 series)
PP	Contact seal on both sides (NNF 50 series)
LS	Contact seal on one side (NNF 50 series)
2LS	Contact seal on both sides (3194 series)
NR	Snap ring groove in outer ring with suitable snap ring
K	Tapered bore, taper 1:12
K30	Tapered bore, taper 1:30

Suffixes	Special surface treatment
B	Surface treated rollers

Double row cylindrical roller bearings

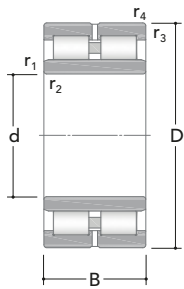

NNU

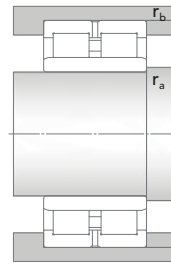

Main dimensions			Basic load ratings		Speed ratings	Dimensions				Mass	Designation	
d	D	B	Dynamic C	Static C ₀	Limiting	r _{1,2min}	r _{3,4min}	r _{amax}	r _{bmax}		Cylindrical bore	Tapered bore
[mm]			[kN]		[rpm]	[mm]				[kg]	–	–
100	140	40	125	252	5200	1,1	1,1	1	1	1,9	NNU 4920	NNU 4920 K
	140	70/40	125	253	4000	1,1	1,1	1	1	2,5	315033	–
	140	80/40	125	251	4000	1,1	1,1	1	1	2,65	319114	–
	150	37	147	248	5000	1,5	1,5	1,5	1,5	2,2	NN 3020	NN 3020 K
	165	65	347	563	2900	1,1	2	1	2	5,5	NNU 4120	NNU 4120 K30
105	145	40	126	258	5100	1,1	1,1	1	1	2	NNU 4921	NNU 4921 K
	160	41	183	303	4600	2	2	2	2	2,8	NN 3021	NN 3021 K
	175	69	400	668	2900	1,1	2	1	2	6,7	NNU 4121	NNU 4121 K30
110	150	40	127	268	5000	1,1	1,1	1	1	2,05	NNU 4922	NNU 4922 K
	170	45	213	359	4400	2	2	2	2	3,55	NN 3022	NN 3022 K
	180	69	409	702	2600	1,1	2	1	2	6,95	NNU 4122	NNU 4122 K30
120	165	45	170	339	4500	1,1	1,1	1	1	2,8	NNU 4924	NNU 4924 K
	165	45	195	373	3400	1	1	1	1	2,8	319826	–
	180	46	221	389	4200	2	2	2	2	3,85	NN 3024	NN 3024 K
	200	80	510	861	2500	1,1	2	1	2	11	NNU 4124	NNU 4124 K30
	215	130/100	685	1110	1800	2x60°	1,1	2	1	15,5	322978	–
127	174,65	75,41	311	651	3000	1,1	1,5	1	1,5	5,3	315643	–
130	180	50	182	383	3900	1,5	1,5	1,5	1,5	3,85	NNU 4926	NNU 4926 K
	200	52	275	467	3700	1,1	2	2	2	5,75	NN 3026	NN 3026 K
	210	80	549	955	2400	2	1,1	1	2	10,5	NNU 4126	NNU 4126 K30
140	190	50	184	395	3900	1,5	1,5	1,5	1,5	4,1	NNU 4928	NNU 4928 K
	210	53	286	517	3500	2	2	2	2	6,2	NN 3028	NN 3028 K
	225	85	610	1030	2100	2,1	2,1	2	2	13	NNU 4128	NNU 4128 K30
150	190	40	190	445	3700	1,1	1,1	1	1	2,75	NN 4830	NN 4830 K
	210	60	319	647	3600	2	2	2	2	6,25	NNU 4930	NNU 4930 K
	225	56	321	566	3400	2,1	2,1	2	2	7,5	NN 3030	NN 3030 K
	250	100	732	1270	2000	2,1	2,1	2	2	18	NNU 4130	NNU 4130 K30
155	220	60	321	676	2500	1	2	1	2	7,6	–	314781 K
160	220	60	317	673	3300	2	2	2	2	6,6	NNU 4932	NNU 4932 K
	240	60	359	650	3200	2,1	2,1	2	2	9,1	–	NN 3032 K
	265	120	996	1770	1800	3	3	2,5	2,5	27	320160	–
	270	109	906	1510	1800	2,1	2,1	2	2	25	NNU 4132	NNU 4132 K30

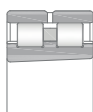

NN

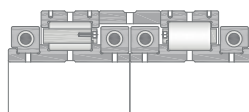

2ROW SCR

Main dimensions			Basic load ratings		Speed ratings	Dimensions				Mass	Designation	
d	D	B	Dynamic C	Static C ₀	Limiting	r _{1,2min}	r _{3,4min}	r _{amax}	r _{bmax}		Cylindrical bore	Tapered bore
[mm]			[kN]		[rpm]	[mm]				[kg]	–	–
165,10	225,45	84,15	490	1100	2300	1,5	1,5	1,5	1,5	10	315642	–
170	230	60	323	682	3200	2	2	2	2	6,95	NNU 4934	NNU 4934 K
	230	80	530	1170	2300	2	2	2	2	9,55	322340	–
	260	67	445	802	2900	2,1	2,1	2	2	12,5	–	NN 3034 K
	260	115/112,5	806	1630	2000	2,1	2,1	2	2	22	320687	–
	280	109	933	1600	1700	2,1	2,1	2	2	26	NNU 4134	NNU 4134 K30
180	250	69	390	842	2900	2	2	2	2	10,5	NNU 4936	NNU 4936 K
	280	74	547	995	2700	2,1	2,1	2	2	16,5	–	NN 3036 K
	300	118	1050	1820	1600	3	3	2,5	2,5	32,5	NNU 4136	NNU 4136 K30
190	260	69	394	879	2600	2	2	2	2	11	NNU 4938	NNU 4938 K
	290	75	577	1070	2500	2,1	2,1	2	2	17	–	NN 3038 K
	320	128	1280	2160	1500	3	3	2,5	2,5	41	NNU 4138	NNU 4138 K30
200	250	50	237	593	2000	1,1	1,5	1	1,5	5,75	NNU 4840	NNU 4840 K
	280	80	466	1020	2500	2,1	2,1	2	2	15	NNU 4940	NNU 4940 K
	310	82	630	1120	2400	2,1	2,1	2	2	22	–	NN 3040 K
	310	115	974	1830	1600	2,1	2,1	2	2	31,5	313639	–
	333,98	174,60	1750	2740	1400	7x45°	7x45°	7	7	69,5	322185	–
	340	140	1420	2520	1400	3	3	2,5	2,5	51	NNU 4140	NNU 4140 K30
210	320	195/115	989	2050	1500	2,1	2,1	2	2	40,5	322459	–
220	300	80	493	1120	2300	2,1	2,1	2	2	16,5	NNU 4944	NNU 4944 K
	300	100	872	1890	1800	2,1	2,1	2	2	20,5	322341	–
	330	115	995	1930	1500	2,1	2,1	2	2	34,5	314889	–
	340	90	790	1440	2100	3	3	2,5	2,5	28,5	–	NN 3044 K
	370	150	1610	2890	1200	4	4	3	3	65	NNU 4144	NNU 4144 K30
240	300	60	348	924	1800	1,1	2	1	2	9,9	NNU 4848	NNU 4848 K
	320	80	511	1210	2100	2,1	2,1	2	2	17,5	NNU 4948	NNU 4948 K
	320	100	860	1950	1200	2,1	2,1	2	2	22,5	326257	–
	360	92	817	1540	2000	3	3	2,5	2,5	32	NN 3048	NN 3048 K
	400	160	1900	3580	1100	4	4	3	3	85	NNU 4148	NNU 4148 K30
260	360	100	725	1680	1900	2,1	2,1	2	2	30,5	NNU 4952	NNU 4952 K
	360	102	970	2190	1400	9x20°	2,1	-	2	32	314997	–
	370	110	1120	2320	1400	3	3	2	2	38,5	316028	–
	400	104	980	1890	1800	4	4	3	3	46	–	NN 3052 K

Double row cylindrical roller bearings

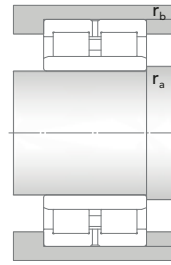
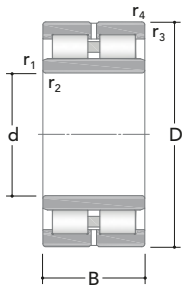

NNU

Main dimensions			Basic load ratings		Speed ratings	Dimensions				Mass	Designation	
d	D	B	Dynamic C	Static C ₀	Limiting	r _{1,2min}	r _{3,4min}	r _{amax}	r _{bmax}		Cylindrical bore	Tapered bore
[mm]			[kN]		[rpm]	[mm]				[kg]	-	-
260	400	140	1590	3100	1200	4	4	3	3	63,5	NNU 4052	NNU 4052 K
	440	180	2120	3870	1100	4	4	3	3	110	NNU 4152	NNU 4152 K30
	480	260	3110	5830	860	5	5	4	4	205	313621	-
280	350	69	439	1170	1300	1,1	2	1	2	15,5	NNU 4856	NNU 4856 K
	380	100	735	1760	1800	2,1	2,1	2	2	32,5	NNU 4956	NNU 4956 K
	380	100	744	1760	1300	2,1	2,1	2	2	33,5	NNUP 4956	-
	400	142,50	1500	3710	1100	3	3	2,5	2,5	60	314070	-
	410	150	1700	3740	1100	4	4	3	3	61	314897	-
	420	106	1040	2040	1600	4	4	3	3	49,5	-	NN 3056 K
	420	140	1580	3090	1100	4	4	3	3	66,5	NNU 4056	NNU 4056 K
	460	180	2450	4670	1000	5	5	4	4	120	NNU 4156	NNU 4156 K30
	470	200	2830	5550	990	3	5	2,5	4	150	315976	-
300	380	80	571	1540	1300	1,5	2,1	1,5	2	22	NNU 4860	NNU 4860 K
	420	118	990	2330	1600	3	3	2,5	2,5	50	NNU 4960	NNU 4960 K
	420	150	1810	4420	1300	6,4x20°	1,5	6	1,5	55,5	326805	-
	460	118	1210	2360	1500	4	4	3	3	68,5	-	NN 3060 K
	460	160	1960	3990	1100	4	4	3	3	96	NNU 4060	NNU 4060 K
	460	180	2540	5430	1100	4	4	3	3	118	320119	-
	500	200	2780	5270	900	5	5	4	4	155	NNU 4160	NNU 4160 K30
320	400	80	735	2050	1200	1,5	2,1	1,5	2	23,5	NNU 4864	NNU 4864 K
	440	118	1020	2450	1600	3	3	2,5	2,5	53	NNU 4964	NNU 4964 K
	440	118	1030	2450	1100	3	3	2,5	2,5	55,5	NNUP 4964	-
	460	120	1680	3590	1000	3	3	2,5	2,5	70	322216	-
	480	121	1270	2550	1400	4	4	3	3	74	-	NN 3064 K
	480	160	2070	4290	1000	4	4	3	3	100	NNU 4064	NNU 4064 K
	480	175	2380	5290	1000	4	1,5	3	1,5	115	315583	-
	540	218	3290	6170	830	5	5	4	4	200	NNU 4164	NNU 4164 K30
	340	420	80	628	1800	1200	1,5	2,1	1,5	2	25	NNU 4868
420		80	623	1800	1100	2,1	2,1	2	2	24,5	NNUP 4868	-
460		118	1070	2610	1400	3	3	2,5	2,5	56	NNU 4968	NNU 4968 K
520		133	1600	3190	1300	5	5	4	4	97,5	-	NN 3068 K
520		180	2480	5070	920	5	5	4	4	140	NNU 4068	NNU 4068 K
520		305/200	3180	7060	940	5	5	4	4	185	320118	-
580		243	3920	7390	820	5	5	4	4	260	NNU 4168	NNU 4168 K30
350	500	190	2370	5600	900	5	5	4	4	115	314563	-
	520	150	2040	4470	930	5	5	4	4	110	319878	-

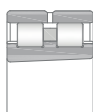
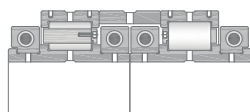

NN

2ROW SCR

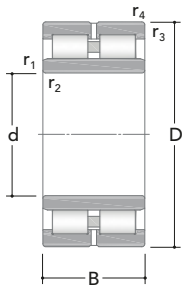
Main dimensions			Basic load ratings		Speed ratings	Dimensions				Mass	Designation	
d	D	B	Dynamic C	Static C ₀	Limiting	r _{1,2min}	r _{3,4min}	r _{amax}	r _{bmax}		Cylindrical bore	Tapered bore
[mm]			[kN]		[rpm]	[mm]				[kg]	-	-
355,59	558,80	279,40	4280	8330	800	10,5x45°	3x45°	10	3	270	322186	-
360	480	118	1070	2770	1400	3	3	2,5	2,5	58,5	NNU 4972	NNU 4972 K
	500	125	1730	3570	1000	3	3	2,5	2,5	72	320075	-
	500	125	1990	4280	1000	3	3	2,5	2,5	80	322217	-
	510	190	2540	6020	940	5	5	4	4	120	320299	-
	540	134	1670	3420	1200	5	5	4	4	105	-	NN 3072 K
	540	180	2700	5660	940	5	5	4	4	140	NNU 4072	NNU 4072 K
	600	243	4120	8420	730	5	5	4	4	275	NNU 4172	NNU 4172 K30
370	520	220/193	2690	6680	820	13,7x20°	1,5	-	1,5	130	319961	-
380	480	100	926	2530	1000	1,5	2,1	1,5	2	44	NNU 4876	NNU 4876 K
	520	140	1390	3530	1200	4	4	3	3	87,5	NNU 4976	NNU 4976 K
	540	130	1960	4270	920	4	4	3	3	100	326131	-
	540	150	2430	5450	940	8,5x20°	2	-	2	110	316062	-
	540	200	3050	6890	820	5	2	4	2	145	320041	-
	560	135	1610	3410	1200	5	5	4	4	110	-	NN 3076 K
	560	180	2750	5940	840	5	5	4	4	150	NNU 4076	NNU 4076 K
	620	243	4190	8380	710	5	5	4	4	285	NNU 4176	NNU 4176 K30
400	500	100	941	2690	1000	1,5	2,1	1,5	2	46	NNU 4880	NNU 4880 K
	500	100	941	2690	1000	2,1	2,1	2	2	45,5	NNUP 4880	-
	540	140	1410	3760	1200	4	4	3	3	91,5	NNU 4980	NNU 4980 K
	560	205	3050	7660	750	13,5x20°	2	-	2	160	314987	-
	560	205	3020	7740	740	5	2	4	2	160	314987	-
	590	220	3600	8190	820	5	5	4	4	210	315802	-
	600	148	2070	4450	1100	5	5	4	4	140	-	NN 3080 K
	600	200	3330	7060	770	5	5	4	4	205	NNU 4080	NNU 4080 K
	600,19	200	3330	7130	790	5	5	4	4	200	326880	-
	600,19	200	3360	7120	790	5	5	4	4	205	326363	-
650	250	4550	9340	670	6	6	5	5	325	NNU 4180	NNU 4180 K30	
406,40	647,70	342,80	6200	12290	630	13x45°	5x45°	12	5	435	322187	-
410	600	140	3650	8570	830	5	5	4	4	215	316019	-
420	520	100	968	2810	830	1,5	2,1	1,5	2	48	NNU 4884	NNU 4884 K
	560	140	1470	3980	1100	4	4	3	3	95,5	NNU 4984	NNU 4984 K
	580	130	2240	4710	840	4	4	3	3	110	320074	-
	580	130	2460	5280	840	4	4	3	3	110	326137	-

Double row cylindrical roller bearings

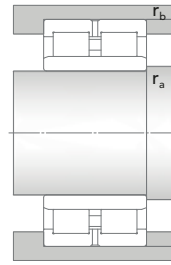

NNU



Main dimensions			Basic load ratings		Speed ratings	Dimensions				Mass	Designation	
d	D	B	Dynamic C	Static C ₀	Limiting	r _{1,2min}	r _{3,4min}	r _{amax}	r _{bmax}		Cylindrical bore	Tapered bore
[mm]			[kN]		[rpm]	[mm]				[kg]	–	–
420	580	160	2260	5300	860	4	4	3	3	125	313555	–
	580	160	2240	5360	830	4	4	3	3	125	313555	–
	580	160	2250	5380	830	4	4	3	3	125	313555	–
	600	220	3430	8710	740	2	2	2	2	205	314982	–
	620	150	2050	4480	1080	5	5	4	4	145	–	NN 3084 K
	620	200	3430	7460	770	5	5	4	4	183	NNU 4084	NNU 4084 K
	620	200	3370	7660	740	4	4	3	3	220	314391	–
	620	260	4190	10080	770	6	6	5	5	280	614844	–
700	280	5340	11310	620	6	6	5	5	440	NNU 4184	NNU 4184 K30	
440	540	100	988	2860	850	1,5	2,1	1,5	2	50	NNU 4888	NNU 4888 K
	600	160	2000	5120	1100	4	4	3	3	130	NNU 4988	NNU 4988 K
	620	225	3780	9670	700	12x20°	2	–	2	220	316077	–
	640	230	4470	9790	710	6	6	5	5	250	316521	–
	650	157	2360	5020	1000	6	6	5	5	170	–	NN 3088 K
	650	212	3810	8250	710	6	6	5	5	215	NNU 4088	NNU 4088 K
	720	280	5590	11660	580	6	6	5	5	450	NNU 4188	NNU 4188 K30
457,20	660,40	228,6/203,2	3540	7990	660	6	6	5	5	235	322969	–
460	580	118	1140	3190	860	3	3	2,5	2,5	75	NNU 4892	NNU 4892 K
	620	160	2000	5390	1000	4	4	3	3	135	NNU 4992	NNU 4992 K
	650	235	4240	11040	730	12x20°	3	–	2,5	260	316739	–
	680	163	2500	5410	1000	6	6	5	5	195	–	NN 3092 K
	680	218	4140	8860	660	6	6	5	5	240	NNU 4092	NNU 4092 K
760	300	6220	13020	550	7,5	7,5	6	6	535	NNU 4192	NNU 4192 K30	
480	650	170	2270	6010	1000	5	5	4	4	160	NNU 4996	NNU 4996 K
	700	165	2590	5790	940	6	6	5	5	200	NN 3096	NN 3096 K
	700	218	4240	9490	630	6	6	5	5	275	NNU 4096	NNU 4096 K
	700	260	5170	12380	630	6	6	5	5	345	316189	–
	790	308	6790	14090	540	7,5	7,5	6	6	590	NNU 4196	NNU 4196 K30
487,98	637	175	2910	7530	640	10x20°	4	–	3	170	326196	–
490	694	174	3650	8890	650	16x20°	5	–	4	215	316639	–
500	650	130	1990	5050	580	5	5	4	4	120	319254	–
	670	170	2260	6050	910	5	5	4	4	165	NNU 49/500	NNU 49/500 K
	680	225	4000	10880	510	5	2	4	2	250	314990	–
	700	170	2590	5360	690	5	5	4	4	210	320570	–

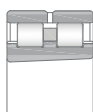

NN

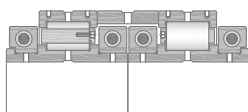

2ROW SCR

Main dimensions			Basic load ratings		Speed ratings	Dimensions				Mass	Designation	
d	D	B	Dynamic C	Static C ₀	Limiting	r _{1,2min}	r _{3,4min}	r _{amax}	r _{bmax}		Cylindrical bore	Tapered bore
[mm]			[kN]		[rpm]	[mm]				[kg]	-	-
500	720	167	2610	5780	910	6	6	5	5	210	NN 30/500	NN 30/500 K
	720	218	4280	9800	620	6	6	5	5	285	NNU 40/500	NNU 40/500 K
	720	218	4610	10740	610	13,5x20°	6	-	5	310	314419	-
	830	325	7210	14910	490	7,5	7,5	6	6	710	NNU 41/500	NNU 41/500 K30
510	760	400/275	5920	13180	580	6	3	5	2,5	485	320996	-
529,91	870	335	7560	16570	480	7,5	7,5	6	6	830	312844	-
530	710	180	2760	7770	850	5	5	4	4	200	NNU 49/530	NNU 49/530 K
	760	260	5620	14090	570	12x20°	5	-	4	510	316536	-
	780	185	3190	7100	830	6	6	5	5	270	NN 30/530	NN 30/530 K
	780	225	4220	9410	550	20x20°	6	-	5	370	326064	-
	780	250	4490	10000	550	6	6	5	5	400	315040	-
	780	250	5310	12150	560	6	6	5	5	420	NNU 40/530	NNU 40/530 K
	780	475/285	6960	17220	480	5	5	4	4	560	320117	-
	870	335	7650	15990	460	7,5	7,5	6	6	790	NNU 41/530	NNU 41/530 K30
546,05	698,50	215,90	3460	7620	590	4	4	3	3	215	464787	-
550	800	260	5660	13146,5	510	14x20°	6	-	5	455	316115	-
560	735	170	2850	6930	620	5	5	4	4	165	326061	-
	740	180	2620	7220	640	5	5	4	4	215	313191	-
	750	190	3100	8500	820	5	5	4	4	235	NNU 49/560	NNU 49/560 K
	820	195	3580	7860	750	6	6	5	5	315	NN 30/560	NN 30/560 K
	820	258	5520	12840	520	6	6	5	5	475	NNU 40/560	NNU 40/560 K
	920	355	8470	18160	440	7,5	7,5	6	6	930	NNU 41/560	NNU 41/560 K30
600	800	200	3450	10030	750	5	5	4	4	280	NNU 49/600	NNU 49/600 K
	820	288	6270	17900	510	15x20°	3	-	2,5	470	319584	-
	870	200	3650	8560	700	6	6	5	5	355	NN 30/600	NN 30/600 K
	870	272	6570	15510	500	6	6	5	5	530	NNU 40/600	NNU 40/600 K
	980	375	9690	21080	400	7,5	7,5	6	6	1100	NNU 41/600	NNU 41/600 K30
630	850	218	3890	11260	700	6	6	5	5	355	NNU 49/630	NNU 49/630 K
	920	212	4150	9680	670	7,5	7,5	6	6	430	NN 30/630	NN 30/630 K
630	920	290	7340	17150	480	7,5	7,5	6	6	635	NNU 40/630	NNU 40/630 K
	1030	400	10680	23550	360	7,5	7,5	6	6	1330	NNU 41/630	NNU 41/630 K30

Double row cylindrical roller bearings

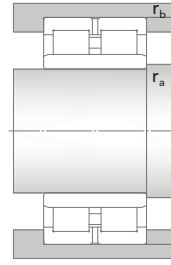
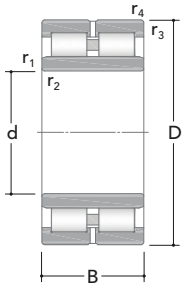

NNU

Main dimensions			Basic load ratings		Speed ratings	Dimensions				Mass	Designation	
d	D	B	Dynamic C	Static C ₀	Limiting	r _{1,2min}	r _{3,4min}	r _{amax}	r _{bmax}		Cylindrical bore	Tapered bore
[mm]			[kN]		[rpm]	[mm]				[kg]	-	-
635	762	101,60	1640	4540	460	5	5	4	4	86,5	319943	-
650	920	335	8270	23080	440	17x20°	4	-	3	740	326894	-
660	880	225	4040	11770	490	6	6	5	5	390	313477	-
670	900	230	4800	13570	670	6	6	5	5	410	NNU 49/670	NNU 49/670 K
	980	230	4860	11290	630	7,5	7,5	6	6	530	NN 30/670	NN 30/670 K
	980	308	8120	19510	430	7,5	7,5	6	6	765	NNU 40/670	NNU 40/670 K
	1090	412	11680	25140	350	7,5	7,5	6	6	1500	NNU 41/670	NNU 41/670 K30
710	950	243	5210	15110	570	6	6	5	5	480	NNU 49/710	NNU 49/710 K
	1030	236	5530	13040	580	7,5	7,5	6	6	590	NN 30/710	NN 30/710 K
	1030	315	9060	21580	400	7,5	7,5	6	6	850	NNU 40/710	NNU 40/710 K
	1150	438	12980	28470	330	9,5	9,5	8	8	1790	NNU 41/710	NNU 41/710 K30
723,98	927,20	190	4230	11900	500	6	2	5	2	340	322191	-
750	920	170	3310	10000	460	5	5	4	4	240	NN 48/750	NN 48/750 K
	1000	250	5310	15920	570	6	6	5	5	540	NNU 49/750	NNU 49/750 K
	1000	250	6030	16420	420	6	6	5	5	575	314420	-
	1090	250	6890	15990	540	7,5	7,5	6	6	705	NN 30/750	NN 30/750 K
	1090	335	9980	23730	370	7,5	7,5	6	6	925	NNU 40/750	NNU 40/750 K
	1220	475	15560	35390	290	9,5	9,5	8	8	2230	NNU 41/750	NNU 41/750 K30
760	1030	400	11860	33820	-	7,5	4	6	3	1280	239503	-
800	1060	258	5630	16780	-	6	6	5	5	615	NNU 49/800	NNU 49/800 K
	1150	258	7620	17940	-	7,5	7,5	6	6	790	NN 30/800	NN 30/800 K
	1150	345	10530	25890	-	7,5	7,5	6	6	1140	NNU 40/800	NNU 40/800 K
	1260	375	12330	27810	-	9,5	9,5	8	8	1850	326379	-
	1280	475	16050	36230	-	9,5	9,5	8	8	2390	NNU 41/800	NNU 41/800 K30
850	1120	272	5810	17990	-	6	6	5	5	360	NNU 49/850	NNU 49/850 K
	1220	272	7690	18250	-	7,5	7,5	6	6	480	NN 30/850	NN 30/850 K
	1220	365	11410	28100	-	7,5	7,5	6	6	300	NNU 40/850	NNU 40/850 K
900	1180	280	6440	19720	-	6	6	5	5	805	NNU 49/900	NNU 49/900 K
	1280	280	8050	19730	-	7,5	7,5	6	6	1050	NN 30/900	NN 30/900 K
	1280	375	12520	31140	-	7,5	7,5	6	6	1500	NNU 40/900	NNU 40/900 K

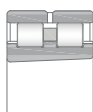

NN

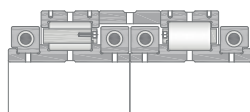

2ROW SCR

Main dimensions			Basic load ratings		Speed ratings	Dimensions				Mass	Designation	
d	D	B	Dynamic C	Static C ₀	Limiting	r _{1,2min}	r _{3,4min}	r _{amax}	r _{bmax}		Cylindrical bore	Tapered bore
[mm]			[kN]		[rpm]	[mm]				[kg]	–	–
950	1250	300	7200	22340	–	7,5	7,5	6	6	960	NNU 49/950	NNU 49/950 K
	1360	300	8870	22220	–	7,5	7,5	6	6	1300	NN 30/950	NN 30/950 K
	1360	412	13660	35210	–	7,5	7,5	6	6	1900	NNU 40/950	NNU 40/950 K
1000	1320	315	8360	25620	–	7,5	7,5	6	6	1250	NNU 49/1000	NNU 49/1000 K
	1320	315	8360	25620	–	7,5	7,5	6	6	1200	NN 49/1000	NN 49/1000 K
	1420	308	9870	24200	–	7,5	7,5	6	6	1400	NN 30/1000	NN 30/1000 K
	1420	412	14960	37310	–	7,5	7,5	6	6	2000	NNU 40/1000	NNU 40/1000 K
1060	1400	335	10240	30380	–	7,5	7,5	6	6	1350	NNU 49/1060	NNU 49/1060 K
	1500	325	10660	27210	–	9,5	9,5	8	8	1650	NN 30/1060	NN 30/1060 K
1120	1460	335	10200	31250	–	7,5	7,5	6	6	1450	NNU 49/1120	NNU 49/1120 K
1180	1540	355	11540	35290	–	7,5	7,5	6	6	1650	NNU 49/1180	NNU 49/1180 K
1311	1720	300	12110	34120	–	7,5	7,5	6	6	1820	326372	–
1320	1720	400	13490	41980	–	7,5	7,5	6	6	3100	NNU 49/1320	NNU 49/1320 K
	1720	400	13490	41980	–	7,5	7,5	6	6	3060	NN 49/1320	NN 49/1320 K

Double row full complement cylindrical roller bearings

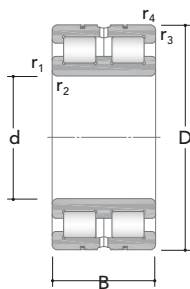

SL01

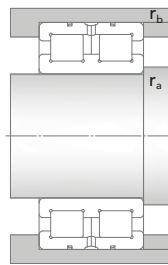

Main dimensions			Basic load ratings		Speed ratings		Dimensions				Mass	Designation
d	D	B	Dynamic C	Static C ₀	Reference	Limiting	r _{1,2min}	r _{3,4min}	r _{amax}	r _{bmax}		
[mm]			[kN]		[rpm]		[mm]				[kg]	–
20	42	30	51,1	56,3	8300	8300	0,6	0,3	0,5	0,3	0,2	NNCF 5004 V
25	47	30	57,0	69,6	6700	7400	0,6	0,3	0,5	0,3	0,23	NNCF 5005 V
30	55	34	71,7	86,5	5800	6300	1	0,3	1	0,3	0,35	NNCF 5006 V
35	62	36	86,5	110	5100	5600	1	0,3	1	0,3	0,46	NNCF 5007 V
40	68	38	102	139	4600	5200	1	0,3	1	0,3	0,56	NNCF 5008 V
45	75	40	109	155	4100	4500	1	0,3	1	0,3	0,71	NNCF 5009 V
50	80	40	137	193	3800	4200	1	0,3	1	0,3	0,76	NNCF 5010 V
55	90	46	185	275	3300	3600	1,1	0,6	1	0,5	1,15	NNCF 5011 V
60	85	25	75,4	135	3400	3800	1	1	1	1	0,48	NNCF 4912 V
	85	25	75,4	135	3400	3800	1	–	1	–	0,49	NNC 4912 V
	85	25	75,4	135	3400	3800	1	–	1	–	0,47	NNCL 4912 V
	95	46	191	299	3200	3300	1,1	0,6	1	0,5	1,25	NNCF 5012 V
65	100	46	202	321	2900	3200	1,1	0,6	1	0,5	1,3	NNCF 5013 V
70	100	30	111	192	2900	3200	1	1	1	1	0,77	NNCF 4914 V
	100	30	111	192	2900	3200	1	–	1	–	0,78	NNC 4914 V
	100	30	110	192	2900	3200	1	–	1	–	0,75	NNCL 4914 V
	110	54	229	343	2700	3100	1,1	0,6	1	0,5	1,85	NNCF 5014 V
75	115	54	241	377	2500	2700	1,1	0,6	1	0,5	1,95	NNCF 5015 V
80	110	30	118	213	2500	2800	1	1	1	1	0,87	NNCF 4916 V
	110	30	118	213	2500	2800	1	–	1	–	0,88	NNC 4916 V
	110	30	118	213	2500	2800	1	–	1	–	0,85	NNCL 4916 V
	125	60	297	452	2300	2400	1,1	0,6	1	0,5	2,6	NNCF 5016 V
85	130	60	302	472	2300	2500	1,1	0,6	1	0,5	2,7	NNCF 5017 V
90	125	35	157	296	2300	2500	1,1	1,1	1	1	1,35	NNCF 4918 V
	125	35	157	296	2300	2500	1,1	–	1	–	1,35	NNC 4918 V
	125	35	157	296	2300	2500	1,1	–	1	–	1,3	NNCL 4918 V
	140	67	356	552	2100	2300	1,5	1	1,5	1	3,6	NNCF 5018 V

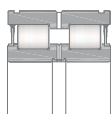

NNF (SL04)

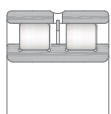

NNCL-C (SL02)

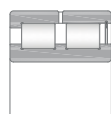

NNCF

Main dimensions			Basic load ratings		Speed ratings		Dimensions				Mass	Designation
d	D	B	Dynamic C	Static C ₀	Reference	Limiting	r _{1,2min}	r _{3,4min}	r _{amax}	r _{bmax}		
[mm]			[kN]		[rpm]		[mm]				[kg]	-
100	140	40	204	399	1900	2200	1,1	1,1	1	1	1,95	NNCF 4920 V
	140	40	204	399	1900	2200	1,1	-	1	-	1,95	NNC 4920 V
	140	40	204	399	1900	2200	1,1	-	1	-	1,9	NNCL 4920 V
	150	67	375	614	1900	2100	1,1	-	1	-	3,95	NNCF 5020 V
105	145	47	228	474	880	1700	2	1	2	1	2,4	319372
110	150	40	215	429	1800	2000	1,1	1,1	1	1	2,1	NNCF 4922 V
	150	40	215	429	1800	2000	1,1	-	1	-	2,15	NNC 4922 V
	150	40	215	429	1800	2000	1,1	-	1	-	2,1	NNCL 4922 V
	170	80	496	799	1700	1800	1,5	-	1,5	-	6,3	NNCF 5022 V
120	165	45	236	478	1600	1800	2	1	2	1	2,9	NNCF 4924 V
	165	45	236	478	1600	1800	1,5	1,5	1,5	1,5	2,95	NNC 4924 V
	165	45	236	478	1600	1800	1,5	-	1,5	-	2,85	NNCL 4924 V
	180	80	527	878	1600	1600	1,1	-	1	-	6,75	NNCF 5024 V
130	180	50	266	529	1500	1700	2	2	2	2	3,9	NNCF 4926 V
	180	50	266	529	1500	1700	2	-	2	-	3,95	NNC 4926 V
	180	50	266	529	1500	1700	2	-	2	-	3,8	NNCL 4926 V
	200	95	735	1220	1400	1600	1,1	-	1	-	10	NNCF 5026 V
140	190	50	278	566	1400	1600	2	2	2	2	4,15	NNCF 4928 V
	190	50	278	566	1400	1600	2	-	2	-	4,2	NNC 4928 V
	190	50	278	566	1400	1600	2	-	2	-	4,1	NNCL 4928 V
	210	95	792	1350	1300	1500	1,1	-	1	-	11	NNCF 5028 V
150	190	40	247	574	1400	1500	2	2	2	2	2,8	NNCF 4830 V
	190	40	247	574	1400	1500	2	-	2	-	2,9	NNC 4830 V
	190	40	247	574	1400	1500	2	-	2	-	2,7	NNCL 4830 V
	210	60	417	816	1300	1400	1,1	-	1	-	6,55	NNCF 4930 V
	210	60	417	816	1300	1400	1,1	-	1	-	6,65	NNC 4930 V
	210	60	417	816	1300	1400	2	2	2	2	6,45	NNCL 4930 V
	225	100	812	1400	1200	1400	2,1	2,1	2	2	13,5	NNCF 5030 V
160	200	40	252	603	1300	1400	1,5	-	1,5	-	3	NNCF 4832 V
	200	40	252	603	1300	1400	1,5	-	1,5	-	3,1	NNC 4832 V
	200	40	252	603	1300	1400	2	2	2	2	2,9	NNCL 4832 V
	220	60	429	899	1200	1300	1,5	1,5	1,5	1,5	6,9	NNCF 4932 V
	220	60	429	899	1200	1300	1,5	-	1,5	-	7	NNC 4932 V
	220	60	429	899	1200	1300	1,5	-	1,5	-	6,8	NNCL 4932 V

Double row full complement cylindrical roller bearings

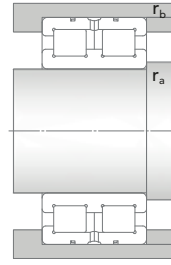
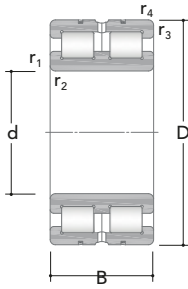

SL01

Main dimensions			Basic load ratings		Speed ratings		Dimensions				Mass	Designation
d	D	B	Dynamic C	Static C ₀	Reference	Limiting	r _{1,2min}	r _{3,4min}	r _{amax}	r _{bmax}		
[mm]			[kN]		[rpm]		[mm]				[kg]	–
160	240	109	922	1590	1100	1200	2,1	2,1	2	2	16	NNCF 5032 V
170	215	45	276	647	1200	1300	1,5	–	1,5	–	4	NNCF 4834 V
	215	45	276	647	1200	1300	1,5	–	1,5	–	4,1	NNC 4834 V
	215	45	276	647	1200	1300	2,1	2,1	2	2	3,9	NNCL 4834 V
	230	60	439	932	1100	1200	3	3	2,5	2,5	7,2	NNCF 4934 V
	230	60	439	932	1100	1200	2	2	2	2	7,35	NNC 4934 V
	230	60	439	932	1100	1200	2	–	2	–	7,1	NNCL 4934 V
	260	122	1180	2090	1000	1100	2,1	–	2	–	23	NNCF 5034 V
180	225	45	285	689	1100	1200	3	3	2,5	2,5	4,2	NNCF 4836 V
	225	45	285	689	1100	1200	2	2	2	2	4,3	NNC 4836 V
	225	45	285	689	1100	1200	2	–	2	–	4,1	NNCL 4836 V
	250	69	581	1210	1000	1100	2,1	–	2	–	10,5	NNCF 4936 V
	250	69	581	1210	1000	1100	2,1	–	2	–	11	NNC 4936 V
	250	69	581	1210	1000	1100	4	4	3	3	10,5	NNCL 4936 V
	280	136	1380	2460	1000	1000	2	–	2	–	30,5	NNCF 5036 V
190	240	50	317	744	1000	1100	2,1	–	2	–	5,5	NNCF 4838 V
	240	50	317	744	1000	1100	2,1	–	2	–	5,65	NNC 4838 V
	240	50	317	744	1000	1100	4	4	3	3	5,3	NNCL 4838 V
	260	69	587	1260	1000	1100	2,1	–	2	–	11	NNCF 4938 V
	260	69	587	1260	1000	1100	3	3	2,5	2,5	11	NNC 4938 V
	260	69	587	1260	1000	1100	3	–	2,5	–	11	NNCL 4938 V
	290	136	1430	2590	970	1100	2,1	2,1	2	2	31,5	NNCF 5038 V
200	250	50	323	793	1000	1100	2,1	–	2	–	5,8	NNCF 4840 V
	250	50	323	793	1000	1100	3	3	2,5	2,5	5,9	NNC 4840 V
	250	50	323	793	1000	1100	3	–	2,5	–	5,7	NNCL 4840 V
	280	80	686	1470	970	1100	4	4	3	3	15,5	NNCF 4940 V
	280	80	686	1470	970	1100	2,1	2,1	2	2	16	NNC 4940 V
	280	80	686	1470	970	1100	2,1	–	2	–	15,5	NNCL 4940 V
	310	150	1630	3020	920	1000	3	3	2,5	2,5	41	NNCF 5040 V
	220	270	50	340	853	960	1000	3	–	2,5	–	6,3
270		50	340	853	960	1000	5	5	4	4	6,4	NNC 4844 V
270		50	340	853	960	1000	2,1	2,1	2	2	6,2	NNCL 4844 V
300		80	709	1580	910	1000	3	3	2,5	2,5	17	NNCF 4944 V
300		80	709	1580	910	1000	3	–	2,5	–	17	NNC 4944 V
300		80	709	1580	910	1000	3	–	2,5	–	17	NNCL 4944 V
340		160	1940	3580	820	940	2,1	–	2	–	52,5	NNCF 5044 V

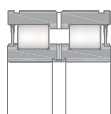

NNF (SL04)

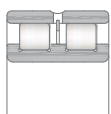

NNCL-C (SL02)

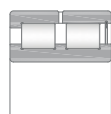

NNCF

Main dimensions			Basic load ratings		Speed ratings		Dimensions				Mass	Designation
d	D	B	Dynamic C	Static C ₀	Reference	Limiting	r _{1,2min}	r _{3,4min}	r _{amax}	r _{bmax}		
[mm]			[kN]		[rpm]		[mm]				[kg]	-
240	300	60	523	1260	870	910	4	-	3	-	9,9	NNCF 4848 V
	300	60	523	1260	870	910	4	-	3	-	10	NNC 4848 V
	300	60	523	1260	870	910	5	5	4	4	9,8	NNCL 4848 V
	320	80	753	1750	820	920	2,1	-	2	-	18,5	NNCF 4948 V
	320	80	753	1750	820	920	4	4	3	3	18,5	NNC 4948 V
	320	80	753	1750	820	920	4	-	3	-	18	NNCL 4948 V
	360	160	2070	3840	780	830	1,1	-	1	-	56	NNCF 5048 V
260	320	60	539	1380	760	840	1,5	-	1,5	-	11	NNCF 4852 V
	320	60	539	1380	760	840	1,1	-	1	-	11	NNC 4852 V
	320	60	539	1380	760	840	1,1	-	1	-	10,5	NNCL 4852 V
	360	100	1130	2540	720	780	1,1	-	1	-	31,5	NNCF 4952 V
	360	100	1130	2540	720	780	1,1	-	1	-	32	NNC 4952 V
	360	100	1130	2540	720	780	1,1	-	1	-	31	NNCL 4952 V
	400	190	2770	5050	670	740	1,5	-	1,5	-	85,5	NNCF 5052 V
280	350	69	713	1830	720	820	1,5	-	1,5	-	16	NNCF 4856 V
	350	69	713	1830	720	820	1,5	-	1,5	-	16	NNC 4856 V
	350	69	713	1830	720	820	2	-	2	-	15,5	NNCL 4856 V
	380	100	1160	2640	670	740	2	-	2	-	33,5	NNCF 4956 V
	380	100	1160	2640	670	740	2	-	2	-	34	NNC 4956 V
	380	100	1160	2640	670	740	2,1	-	2	-	33	NNCL 4956 V
	420	190	2850	5220	650	710	1,1	-	1	-	90,5	NNCF 5056 V
300	380	80	828	2110	670	710	2	-	2	-	22,5	NNCF 4860 V
	380	80	828	2110	670	710	2	-	2	-	23	NNC 4860 V
	380	80	828	2110	670	710	2,1	-	2	-	22	NNCL 4860 V
	420	118	1640	3700	650	670	2	-	2	-	52,5	NNCF 4960 V
	420	118	1640	3700	650	670	2,1	-	2	-	53	NNC 4960 V
	420	118	1640	3700	650	670	1,1	-	1	-	52	NNCL 4960 V
	460	218	3180	6540	580	650	2,1	-	2	-	130	NNCF 5060 V
320	400	80	876	2270	610	680	1,5	-	1,5	-	23,5	NNCF 4864 V
	400	80	876	2270	610	680	2	-	2	-	24	NNC 4864 V
	400	80	876	2270	610	680	2	-	2	-	23	NNCL 4864 V
	440	118	1710	3990	580	630	2,1	-	2	-	55,5	NNCF 4964 V
	440	118	1710	3990	580	630	1,5	-	1,5	-	56	NNC 4964 V
	440	118	1710	3990	580	630	1,5	-	1,5	-	55	NNCL 4964 V
	480	218	3610	6940	540	600	3	-	2,5	-	135	NNCF 5064 V
340	420	80	881	2380	570	620	2	-	2	-	25	NNCF 4868 V

Double row full complement cylindrical roller bearings

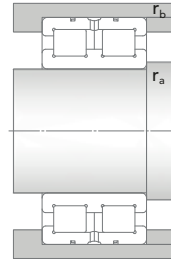
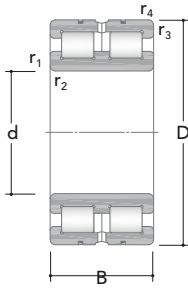

SL01

Main dimensions			Basic load ratings		Speed ratings		Dimensions				Mass	Designation
d	D	B	Dynamic C	Static C ₀	Reference	Limiting	r _{1,2min}	r _{3,4min}	r _{amax}	r _{bmax}		
[mm]			[kN]		[rpm]		[mm]				[kg]	–
340	420	80	881	2380	570	620	2,1	–	2	–	25,5	NNC 4868 V
	420	80	881	2380	570	620	2,1	–	2	–	25,5	NNCL 4868 V
	460	118	1740	4210	540	580	2,1	–	2	–	58,5	NNCF 4968 V
	460	118	1740	4210	540	580	2,1	–	2	–	59	NNC 4968 V
	460	118	1740	4210	540	580	4	–	3	–	58	NNCL 4968 V
	520	243	4290	8250	510	570	2,1	–	2	–	185	NNCF 5068 V
360	440	80	898	2520	530	580	2,1	–	2	–	26,5	NNCF 4872 V
	440	80	898	2520	530	580	2,1	–	2	–	27	NNC 4872 V
	440	80	898	2520	530	580	2,1	–	2	–	26	NNCL 4872 V
	480	118	1760	4470	510	570	4	–	3	–	61,5	NNCF 4972 V
	480	118	1760	4470	510	570	2,1	–	2	–	62	NNC 4972 V
	480	118	1760	4470	510	570	2,1	–	2	–	61	NNCL 4972 V
380	520	243	4330	8480	480	530	3	–	2,5	–	195	NNCF 5072 V
	480	100	1360	3620	510	570	2,1	–	2	–	45	NNCF 4876 V
	480	100	1360	3620	510	570	2,1	–	2	–	45,5	NNC 4876 V
	480	100	1360	3620	510	570	2,1	–	2	–	44	NNCL 4876 V
	520	140	2320	5630	480	520	5	–	4	–	91,5	NNCF 4976 V
	520	140	2320	5630	480	520	2,1	–	2	–	92,5	NNC 4976 V
400	520	140	2320	5630	480	520	2,1	–	2	–	90,5	NNCL 4976 V
	560	243	4580	9050	470	510	3	–	2,5	–	200	NNCF 5076 V
	500	100	1370	3740	480	520	2,1	–	2	–	46	NNCF 4880 V
	500	100	1370	3740	480	520	2,1	–	2	–	46,5	NNC 4880 V
	500	100	1370	3740	480	520	2,1	–	2	–	46	NNCL 4880 V
	540	140	2340	5990	460	510	5	–	4	–	95,5	NNCF 4980 V
420	540	140	2340	5990	460	510	2,1	–	2	–	96,5	NNC 4980 V
	540	140	2340	5990	460	510	2,1	–	2	–	94,5	NNCL 4980 V
	600	272	5380	10990	440	470	4	–	3	–	270	NNCF 5080 V
	520	100	1300	3920	230	400	2,1	–	2	–	49,5	NNCF 4884 V
	520	100	1300	3920	230	400	2,1	–	2	–	49,5	NNC 4884 V
	520	100	1300	3920	230	400	2,1	–	2	–	49,5	NNCL 4884 V
440	560	140	2120	5980	210	370	4	–	3	–	99,5	NNCF 4984 V
	560	140	2120	5980	210	370	4	–	3	–	99,5	NNC 4984 V
	560	140	2120	5980	210	370	4	–	3	–	99,5	NNCL 4984 V
	540	100	1360	4080	210	370	2,1	–	2	–	52	NNCF 4888 V
440	540	100	1360	4080	210	370	2,1	–	2	–	52	NNC 4888 V
	540	100	1360	4080	210	370	2,1	–	2	–	52	NNCL 4888 V

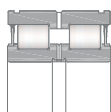

NNF (SL04)

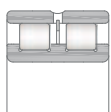

NNCL-C (SL02)

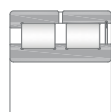

NNCF

Main dimensions			Basic load ratings		Speed ratings		Dimensions				Mass	Designation
d	D	B	Dynamic C	Static C ₀	Reference	Limiting	r _{1,2min}	r _{3,4min}	r _{amax}	r _{bmax}		
[mm]			[kN]		[rpm]		[mm]				[kg]	–
440	600	160	2890	7460	190	360	4	–	3	–	137	NNCF 4988 V
	600	160	2850	7440	190	360	4	–	3	–	137	NNC 4988 V
	600	160	2850	7440	190	360	4	–	3	–	137	NNCL 4988 V
460	580	118	1500	4470	190	350	3	–	2,5	–	76	NNCF 4892 V
	580	118	1500	4470	190	350	3	–	2,5	–	76	NNC 4892 V
	580	118	1500	4470	190	350	3	–	2,5	–	76	NNCL 4892 V
	620	160	2910	7590	180	330	4	–	3	–	140	NNCF 4992 V
	620	160	2910	7590	180	330	4	–	3	–	140	NNC 4992 V
	620	160	2910	7590	180	330	4	–	3	–	140	NNCL 4992 V
480	600	118	1530	4680	180	330	3	–	2,5	–	78,5	NNCF 4896 V
	600	118	1530	4680	180	330	3	–	2,5	–	78,5	NNC 4896 V
	600	118	1530	4680	180	330	3	–	2,5	–	78,5	NNCL 4896 V
	650	170	3200	8210	170	310	5	–	4	–	165	NNCF 4996 V
	650	170	3200	8210	170	310	5	–	4	–	165	NNC 4996 V
	650	170	3200	8210	170	310	5	–	4	–	165	NNCL 4996 V
500	620	118	1560	4840	180	330	3	–	2,5	–	81,5	NNCF 48/500 V
	620	118	1560	4840	180	330	3	–	2,5	–	81,5	NNC 48/500 V
	620	118	1560	4840	180	330	3	–	2,5	–	81,5	NNCL 48/500 V
	670	170	3290	8790	160	310	5	–	4	–	175	NNCF 49/500 V
	670	170	3290	8790	160	310	5	–	4	–	175	NNC 49/500 V
	670	170	3290	8790	160	310	5	–	4	–	175	NNCL 49/500 V
530	650	118	1640	5320	160	310	3	–	2,5	–	85	NNCF 48/530 V
	650	118	1640	5320	160	310	3	–	2,5	–	86	NNC 48/530 V
	650	118	1640	5320	160	310	3	–	2,5	–	84	NNCL 48/530 V
	710	180	3770	10160	150	290	5	–	4	–	200	NNCF 49/530 V
	710	180	3770	10160	150	290	5	–	4	–	200	NNC 49/530 V
	710	180	3770	10160	150	290	5	–	4	–	200	NNCL 49/530 V

Double row full complement cylindrical roller bearings

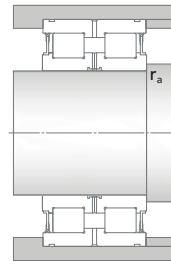
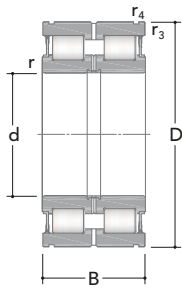

SL04

Main dimensions				Basic load ratings		Speed ratings	Dimensions			Mass	Designation
d	D	B	C	Dynamic C	Static C ₀	Limiting	r _{min}	r _{3,4min}	r _{amax}		
[mm]				[kN]		[rpm]	[mm]			[kg]	–
20	42	30	29	44,5	54,6	2900	0,5	0,3	0,3	0,2	NNF 5004
25	47	30	29	48,8	65,0	2500	0,5	0,3	0,3	0,24	NNF 5005
30	55	34	33	55,9	74,0	2100	0,5	0,3	0,3	0,37	NNF 5006
35	62	36	35	68,9	97,9	1800	0,5	0,3	0,3	0,48	NNF 5007
40	68	38	37	83,7	114,3	1700	0,8	0,6	0,4	0,56	NNF 5008
45	75	40	39	98,7	145,7	1500	0,8	0,6	0,4	0,7	NNF 5009
50	80	40	39	104	158	1300	0,8	0,6	0,4	0,76	NNF 5010
55	90	46	45	124	189	1200	1	0,6	0,6	1,2	NNF 5011
60	95	46	45	129	207	1100	1	0,6	0,6	1,25	NNF 5012
65	100	46	45	133	220	1100	1	0,6	0,6	1,35	NNF 5013
70	110	54	53	180	284	1000	1	0,6	0,6	1,85	NNF 5014
75	115	54	53	198	309	900	1	0,6	0,6	1,95	NNF 5015
80	125	60	59	243	411	860	1,5	0,6	1	2,7	NNF 5016
85	130	60	59	260	422	860	1,5	0,6	1	2,85	NNF 5017
90	140	67	66	306	545	750	1,5	0,6	1	3,7	NNF 5018
95	145	67	66	320	564	750	1,5	0,6	1	3,9	NNF 5019
100	150	67	66	325	569	730	1,5	0,6	1	3,95	NNF 5020
110	170	80	79	403	693	630	1,8	0,6	1,5	6,45	NNF 5022
120	180	80	79	418	738	570	1,8	0,6	1,5	6,9	NNF 5024
130	190	69	68	366	731	550	1,8	0,6	1	6,5	319110
	190	80	79	433	800	550	1,8	0,6	1,5	7,5	319426

Main dimensions				Basic load ratings		Speed ratings	Dimensions			Mass	Designation
d	D	B	C	Dynamic C	Static C ₀	Limiting	r _{min}	r _{3,4min}	r _{amax}		
[mm]				[kN]		[rpm]	[mm]			[kg]	–
130	190	80	79	403	812	560	1,8	0,6	1	7,35	319426
	200	95	94	597	1020	520	1,8	0,6	1,5	10,5	NNF 5026
140	200	80	79	456	861	520	1,8	0,6	1,5	8	319428
	200	80	79	420	864	520	1,8	0,6	1	7,8	319428
	210	95	94	622	1100	510	1,8	0,6	1,5	11	NNF 5028
150	210	80	79	457	897	480	1,8	0,6	1,5	8,4	319430
	210	80	79	435	911	490	1,8	0,6	1	8,25	319430
	225	100	99	720	1260	480	2	0,6	2	13,5	NNF 5030
160	220	80	79	488	994	430	1,8	0,6	1,5	8,8	319432
	220	80	79	450	993	430	1,8	0,6	1	8,65	319432
	240	109	108	764	1390	410	2	0,6	2	16,5	NNF 5032
170	230	80	79	495	1040	440	1,8	0,6	1,5	9,3	319434
	230	80	79	463	1040	420	1,8	0,6	1	9,1	319434
	260	122	121	982	1780	400	2	0,6	2	22,5	NNF 5034
180	240	80	79	511	1080	420	1,8	0,6	1,5	9,8	319436
	240	80	79	484	1080	400	1,8	0,6	1	9,55	319436
	280	136	135	1140	2090	390	2	0,6	2	30	NNF 5036
190	260	80	79	535	1170	380	1,8	0,6	1,5	12,5	319438
	260	80	79	548	1280	370	1,8	0,6	1	12,5	319438
	290	136	135	1140	2160	360	2	0,6	2	31,5	NNF 5038
200	270	80	79	538	1230	370	1,8	0,6	1,5	13	319440
	270	80	79	569	1350	360	1,8	0,6	1	13	319440
	310	150	149	1400	2860	330	2	0,6	2	42	NNF 5040
220	300	95	94	860	1850	310	2	1	1	19,5	322108
	340	160	159	1560	3060	300	2	1	2	53,5	NNF 5044
240	360	160	159	1640	3340	290	2	1	2	57,5	NNF 5048
260	400	160	159	1890	3510	250	3	1,5	1,5	70	320848

Multi row cylindrical roller bearings

Multi row cylindrical roller bearings, also known as Multiroll, are made up of two parts: inner ring (L) and outer assembly (R), which includes outer rings, cage and four rows of rollers.

They are mainly used in rolling mill stands, where they are subjected to very high radial loads and impacts combined with medium-low speeds.

RKB Multiroll bearings are manufactured in different executions, to suit a wide range of applications and environments, above all in the harsh conditions of the steel and aluminum industry. May be available with a cylindrical bore for special design and applications as well as featuring tapered bore (taper 1:12) normally required as replacement for oil film bearings.



Internal clearance

RKB Multi row cylindrical roller bearings are usually manufactured in C3 or C4 radial internal clearance both typical in rolling mill application. Should the bearing be mounted loose fit on rolling mill neck, the radial clearance becomes

C2. Standard radial internal clearance for Multi row cylindrical roller bearings with a cylindrical bore are provided in **Tab. 1 page 72**. For Multi row cylindrical roller bearings with a taper bore are usually produced with an internal clearance reoprted in **Tab. 2 page 73**.

Minimum load

A minimum radial load is requested for Multi row cylindrical roller bearings to perform efficiently, especially in critical working conditions like: high speed, high acceleration and sudden changes of rotating direction. In these operating conditions, a skidding between rollers and raceways can be generated by the inertial forces, influencing negatively the bearing life. Assuming a continuous operation, the minimum radial load can be estimated using the following formula:

$$\frac{F_{rm}}{C_{0r}} > 50$$

Where:

- F_{rm} minimum radial load, [kN];
- C_{0r} basic static load rating, [kN].

Usually, the minimum radial load is reached or surpassed by the weight of the components supported by the bearing together with the loads acting on it, otherwise supplementary radial load must be applied on the Multi row cylindrical roller bearings. In application where a starting up at a low temperature is planned or a lubricant with high viscosity is used, a greater minimum radial load is required.

Designs and variants

Type AF2D/A2D

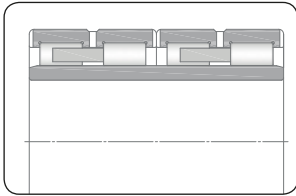

- Design used for small and medium size bearings
- One-piece ribless inner ring
- Two-piece outer ring with three integral ribs
- Double pronged high strength machined steel cage for increased stiffness and resistance to corrosive environments (AF2D)
- Annular groove and lubrication holes in outer ring
- Available with lubrication grooves in rings side faces
- Available with double pronged machined brass cage (A2D)

Type F2CII/EVO

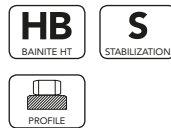
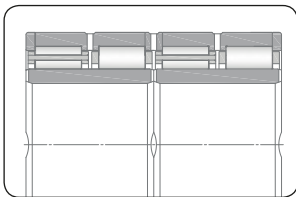

- Design used for large size bearings
- Two-piece ribless inner ring with lubrication grooves in side faces
- Two-piece outer ring with separated side flanges and one central spacer
- Two-piece pin type steel cage with lightened design for optimized lubrication
- Pierced rollers design for increased carrying capacities
- Available with two-piece window type riveted machined brass cage (EVO)

Type Q2ACEVO

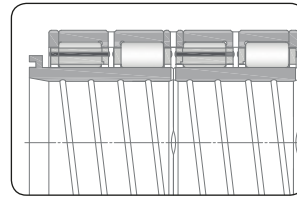

- Design used for large size bearings with increased shoulder on inner ring for seal seating
- Two-piece inner ring with lubrication grooves in side faces
- Two-piece outer ring with separated side flanges and one central spacer
- Two-piece window type riveted machined brass cage
- Annular groove and lubrication holes in outer ring

Type GB2DX

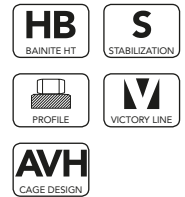
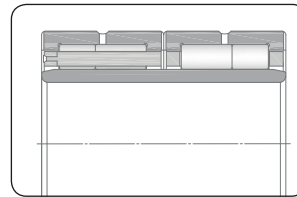

- Designed for rolling mill stands with automatic roll changing device
- One-piece ribless inner ring with increased length of chamfers to facilitate mounting
- Two-piece outer ring with integral ribs
- Two-piece reinforced window type machined brass cage with integral rivets (AVH) for optimized roller drop
- Long-short roller arrangement for better load distribution and reduced edge stress
- Optimized for oil lubrication and automatic grease lubrication systems

Multi row cylindrical roller bearings

Type D2CII

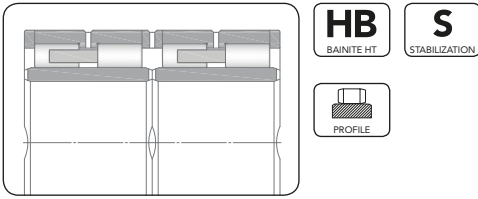

- Design used for medium and large size bearings
- Two-piece ribless inner ring with lubrication grooves in side faces
- Two-piece outer ring with separated side flanges and one central spacer
- Double pronged machined brass cage
- Annular groove and lubrication holes in outer ring
- Design for facilitated mounting and dismounting

Multi row cylindrical roller bearings

Prefixes

L	In a separable bearing: separate inner ring
R	In a separable bearing: outer ring with roller and cage assembly
4CRB	Out of standard four-row cylindrical roller bearing followed by drawing number
NNU 60	Out of standard four-row cylindrical roller bearing followed by dimension indication

Note: unless differently specified, by default the mating of L and its corresponding R always give a C4 internal radial clearance

Suffixes	Main design
A	Two outer rings each with three integral ribs. One inner ring. Two double pronged machined brass cages guided on rolling elements
AF	As A, but with reinforced machined steel cage
B	As A, but with a spacer between the two outer rings
C or All	As A, but with inner ring split into two halves
CF	As C, but with reinforced machined steel cage
DII	Two outer rings each with an integral central rib and one loose flange ring; one spacer. One inner ring split into two halves. Two double pronged machined brass cages guided on rolling elements
EII	Two outer rings each with three integral ribs. One inner ring split into two halves. Four steel pin-type cages and pierced rollers
FII	Two outer rings each with an integral central rib and one loose flange ring; one spacer. One inner ring split into two halves. Four steel pin-type cages and pierced rollers
FIIEVO	As FII, but with two double row window-type machine brass cages
GII or GXII	Two outer rings each with two integral ribs. One inner ring split into two halves. Two double row window-type machined brass cages
GB or GBX	As GII, but with one inner ring in one piece (not split)
H	One outer ring with three loose guide rings and two loose flange rings. One inner ring. Two double pronged machined brass cages
I	Two outer rings each with integral central rib and two loose flange rings; one spacer. Two inner rings. Four pressed steel cages
L	One outer ring with five integral ribs. One inner ring. Four pronged machined brass cages guided on rolling elements
M	As C, but with one wider inner ring
N	As D, but with one wider inner ring
O	As F, but with one wider inner ring
P	As H, but with one wider inner ring
Q	As F, but with one wider inner ring with concentric shoulder
R	As F, but with two wider inner rings; one inner ring with concentric shoulder

Suffixes	Internal design
ZB	Optimized roller profile for improved load distribution. It is not necessarily stated in the bearing code
SP	Special or non-standard bearing
W	One wider inner ring
WS	One wider inner ring with special concentric shoulder

Suffixes	Cage
S	Steel cage

Suffixes	Accuracy, clearance, running
HP	High precision running accuracy (better than P6)

Suffixes	Lubrication
A	Helical groove in inner ring bore
B	Lubrication grooves in side faces of inner and outer rings
C	Lubrication grooves in side face of inner ring
D	Lubrication grooves in side face of outer ring

Suffixes	External design
K	Tapered bore, taper 1:12
K30	Tapered bore, taper 1:30

Suffixes	Annular groove and lubrication holes
1	Annular groove and lubrication holes in spacer between outer rings
2	Annular groove and lubrication holes in outer rings
3	1+2

Multi row cylindrical roller bearings

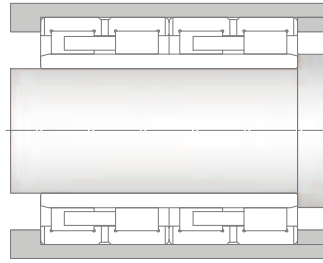
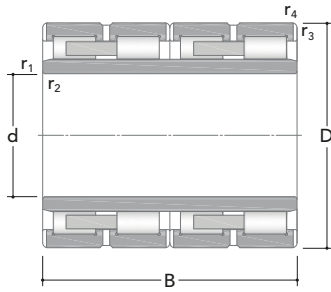

AF2D/A2D

Main dimensions				Basic load ratings		Dimensions		Mass	Designation	
d	D	B	C	Dynamic C	Static C ₀	r _{1,2min}	r _{3,4min}		Cylindrical bore	Tapered bore
[mm]				[kN]		[mm]		[kg]	–	–
105	150	71	71	245	472	0,6	1,1	4,1	–	319148
115	165	107,5	90	386	749	1,1	1,1	8,5	319738	–
125	180	100	90	416	863	1	1,5	7,9	–	319768 K30
127	174,625	150,812	150,812	612	1310	1,1	1,5	10,5	315643	–
139,700	215	195	187	975	2260	3	0,4	25	466971	–
	215	195	187	1170	2530	3	0,4	24	459696	–
140	210	155	155	779	1530	1,1	1,1	17	–	313900
145	210	155	155	767	1550	1,1	1,1	18	314625	–
	225	156	156	865	1650	2	2	23	313924	–
150	230	156	156	870	1640	2	2	24	313891	–
151,500	230	168	168	1020	2190	1,1	2	24	–	314024
	230	168	168	1050	2270	2	2x45°	23	–	467334
160	230	130	130	752	1330	1,5	1,5	17	314190	–
	230	168	168	874	2180	2	2	23,5	315189	–
	233	180	180	1100	2760	2,5	1,8	26,5	457627	–
	240	175	175	1150	2510	1	2	24	–	313436
160,690	260	178,7	166	1060	2520	2,1	1,2x45°	34	–	466949
162	230	130	130	647	1370	1	2	16	–	312863
165,100	225,425	168,275	168,275	978	2210	1,5	1,5	20	315642	–
170	230	130	130	654	1390	2	2	15	313673	–
	230	160	160	1060	2350	2	2	19	322340	–
	240	130	130	885	1790	2	2	19	635122	–
	260	160	160	1070	2120	0,6	1,1	29,5	–	313423
	260	225	225	1600	3320	2,1	2,1	43,5	313587	–
175	260	180	180	1160	3120	1	1,8x45°	32	–	457919
180	260	168	168	1240	2470	2,1	2,1	29,5	313812	–

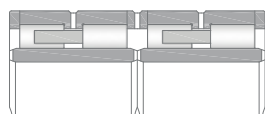

D2C

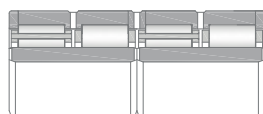

F2CII/EVO

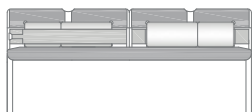

G2B

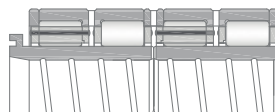

Q2AC

Main dimensions				Basic load ratings		Dimensions		Mass	Designation	
d	D	B	C	Dynamic C	Static C ₀	r _{1,2min}	r _{3,4min}		Cylindrical bore	Tapered bore
[mm]				[kN]		[mm]		[kg]	-	-
181	260	180	180	1090	2600	2	2	29,5	-	314874
	260	180	180	933	2580	1	3,5x45°	28	-	452683
181,500	260	168	168	1090	2530	1,1	2	27,5	-	314023
	260	168	168	937	2590	1,5	1x45°	27	-	467333
182	260	168	183	1100	2570	1	2	28	-	312942
183,330	280	200	200	1330	3430	1,5	2x45°	43	-	457920
190	260	168	168	1110	2590	2	2	27	313651	-
	270	200	200	1460	3320	2,1	2,1	37,5	314199	-
	280	200	200	1670	3320	2,1	2,1	41,5	314049	-
	280	200	200	1450	3320	1,1	2,1	40	-	313583
	290	180	180	1410	2800	1	2,1	41	-	313422
192	270	170	170	1120	2670	1	2,1	28,5	-	313153
200	270	170	170	1130	2690	2,1	2,1	28,5	314553	-
	280	170	170	1350	2990	2,1	2,1	33,5	314385	-
	280	170	170	1390	3170	2,1	2,1	35	319659	-
	280	180	170	1340	2970	2,1	2,1	35	319019	-
	280	200	200	1460	3280	0,6	2,1	39	313893	-
	285	200	200	1430	3840	2,1	2	44	457628	-
	290	192	192	1500	3190	2,1	2,1	42,5	313811	-
	310	230	230	1960	3730	2,1	2,1	63	313639	-
200,833	310	230	230	1810	4700	3	3,2x45°	62,5	-	457922
202	290	192	192	1420	3360	1	2,1	39,5	-	313152
	290	202,230	192	1250	3580	1,5	2,5x45°	49	-	467419
	290	207	192	1410	3350	1	2,1	42,5	-	312858
205	310	225	225	1870	4230	1,1	3	58	-	313584
	240	130	130			2	2	19	635122	
	260	160	160	1400	3390	0,6	1,1	29,5	-	313423
	260	225	225			2,1	2,1	43,5	313587	
210	290	192	192	1402,27	3390,08	2,1	2,1	41	313646	-
220	300	200	200	1718,86	3823,00	2,1	2,1	41	322341	-

Multi row cylindrical roller bearings

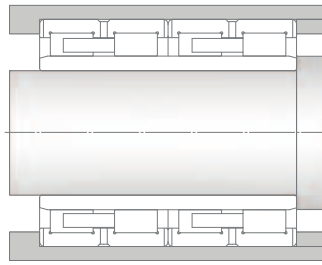
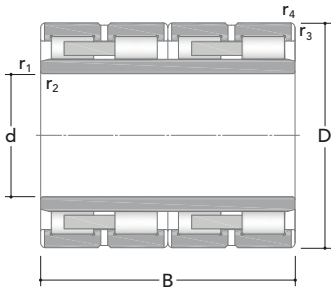

AF2D/A2D

Main dimensions				Basic load ratings		Dimensions		Mass	Designation	
d	D	B	C	Dynamic C	Static C ₀	r _{1,2min}	r _{3,4min}		Cylindrical bore	Tapered bore
[mm]				[kN]		[mm]		[kg]	-	
228,330	325	200	200	1560	4480	1	2	48,5	-	461839
230	330	206	206	1790	3920	2,1	2,1	58	313824	-
	365	250	250	2580	4890	3	3	100	313581	-
	330	220	220	1960	4590	1,1	2,1	57,5	-	313438
231	330	235	220	1660	4210	1,1	2,1	59	-	312943
240	330	180	180	1650	3770	2,1	2,1	49,5	635194	-
	330	220	220	1650	4210	2,1	2,1	58	313921	-
	330	240	220	1670	4260	2,1	2,1	60	320415	-
	360	290	290	3210	6500	8x20°	2	130	322292	-
246,670	380	280	280	2540	7050	3	2,8x45°	115	-	457927
250	340	230	230	1820	4920	3	2,3x45°	65	457629	-
255	370	249	234	2160	5380	1,1	3	82	-	312860
260	360	204	204	1900	4360	2,1	2,1	64,5	314997	-
	360	230	230	1930	4580	3	3	73,5	320956	-
	370	220	220	2100	4570	3	3	77,5	313823	-
	370	240	220	2090	4540	3	3	78,5	319464	-
	400	250	250	2650	5760	1,1	3	110	-	313439
	400	285	285	3020	7290	1,1	3	125	-	313532
400	290	290	3420	6980	4	4	135	313427	-	
265	370	234	234	2160	5330	3	3	80,5	313922	-
266,250	400	285	285	2470	6680	4	3,2x45°	120	-	457929
270	380	295	275	2960	7140	2	1	100	315605	-
280	390	220	220	2150	4960	3	3	82,5	313822	-
	390	250	220	2170	4900	3	3	84,5	319259	-
	390	275	275	2950	7130	7x20°	1,1	100	314719	-
	400	285	285	3010	7280	3	3	120	314070	-
	410	300	300	3400	7470	4	4	130	314897	-
	420	300	300	3390	7260	4	4	150	313487	-
290	390	190	190	1980	4530	2,1	2,1	67	635195	-

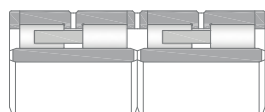

D2C

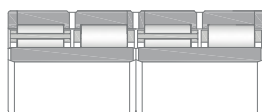

F2CII/EVO

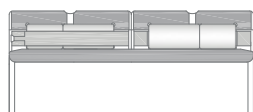

G2B

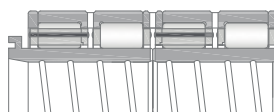

Q2AC

Main dimensions				Basic load ratings		Dimensions		Mass	Designation	
d	D	B	C	Dynamic C	Static C ₀	r _{1,2min}	r _{3,4min}		Cylindrical bore	Tapered bore
[mm]				[kN]		[mm]		[kg]	-	
300	420	300	300	3610	8670	7x20°	1,5	130	314484	-
	420	320	300	3610	8680	4	1,5	135	319129	-
320	460	240	240	2820	7160	3	3	140	322216	
	480	350	350	4770	10750	10x20°	1,5	220	314274	
	480	350	350	4450	10930	1,5	1,5	215	-	316345
330	460	340	340	4080	10080	10,5x20°	1,5	175	313445	-
340	480	350	350	4430	10990	8x20°	1,5	205	314485	-
	480	370	350	4380	10890	4	1,5	200	319040	-
	500	370	370	5070	11680	13x20°	3	260	322261	-
	520	300	300	4180	8870	2	5	215	-	315767
	560	380	380	6570	12820	5	4	350	313404	-
350	500	380	380	4840	11270	5	5	240	314563	-
	500	410	410	5640	13670	11,5x20°	3	285	322777	-
	520	300	300	4160	8920	5	5	220	319878	-
	520	300	300	4160	8920	8x20°	5	220	326909	-
	520	320	300	4150	8880	8x20,5°	5	240	326858	-
356,670	550	400	400	5150	14780	3,2	4x45°	335	-	457939
360	500	250	250	3500	7270	3	3	145	320075	-
	500	250	250	3340	8350	3	3	140	322217	-
	510	400	380	5070	12090	4	1,5	260	316890	-
365	540	300	300	4860	10790	2	2	230	-	313041
370	520	380	380	5290	12970	10x20°	1,5	255	314486	-
380	520	280	280	2780	7080	4	4	185	NUU 4976	-
	540	260	260	3300	8630	4	4	205	326131	-
	540	300	300	4860	10800	8,5x20°	2	220	313030	-
	540	400	380	5840	13800	4	1,5	300	320989	-
	540	400	380	5510	13480	4	1,5	295	315606	-
	540	400	400	5690	13950	10x20°	2	295	313511	-
	540	400	400	6010	14940	10x20°	2	305	326366	-
	560	300	300	4830	9510	13,5x20°	2	260	322189	-
	560	325	325	5090	10540	13,5x20°	5	265	322264	-

Multi row cylindrical roller bearings

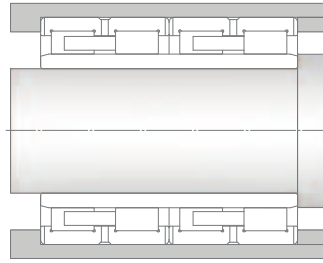
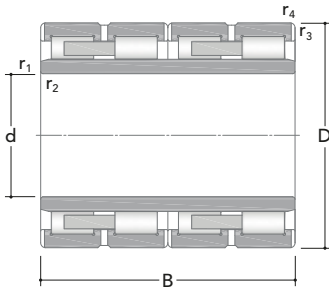

AF2D/A2D

Main dimensions				Basic load ratings		Dimensions		Mass	Designation	
d	D	B	C	Dynamic C	Static C ₀	r _{1,2min}	r _{3,4min}		Cylindrical bore	Tapered bore
[mm]				[kN]		[mm]		[kg]	-	
382,500	590	450	450	6650	15980	5	6,4x45°	425	-	319352
390	540	320	320	5140	12010	10x20°	2	230	322498	-
	550	310	310	4930	11120	11x20°	4	240	313190	-
399,930	590	440	440	8350	20060	10x20°	5	420	313038	-
400	560	410	410	6030	15330	13,5x20°	2	315	313015	-
	590	440	440	7100	16330	5	5	415	315802	-
410	560	400	400	6240	15920	11x20°	2	290	316689	-
	560	400	400	5300	15920	14x20°	2	295	322038	-
	560	420	400	5700	14320	13x20°	2	275	320612	-
	600	440	440	7340	17120	5	5	425	313877	-
412,335	650	488	480	7180	21000	5	4,5x45°	565	-	467373
	650	488	488	8100	18660	4	4	575	-	314964
412,500 420	630	450	450	6450	18760	1,5	4,5x45°	490		457945
	580	260	260	3620	9630	4	4	210	320074	-
	580	320	320	4570	10770	4	4	250	313555	-
	600	440	440	7030	17520	8x20°	2	400	313513	-
	620	400	400	6740	15490	4	4	430	314391	-
431,500	571,500	300	300	4320	9990	10,5x20°	4	210	326361	-
440	620	450	450	7540	19310	12x20°	2	440	314554	-
	620	470	450	6930	17270	14x20°	2	420	320608	-
	650	355	355	6530	13770	12,5x20°	4	420	316899	-
	650	355	355	6050	14540	3	3	400	-	313032
	660	340	340	6480	13650	6	6	430	635043	-
447,295	635,176	463,550	463,550	7950	19690	13,5x20°	5	460	314792	-
450	590	300	300	3810	11930	12x45°	4	245	315811	-
459,950	760	600	600	13530	30390	15x20°	6	1160	312980	-
460	650	355	355	6060	14420	12x20°	3	380	313031	-
	650	424	424	7510	18160	12x20°	3	450	315196	-
	650	460	424	7590	17980	12x20°	3	490	322993	-

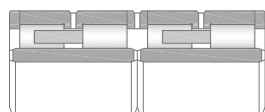
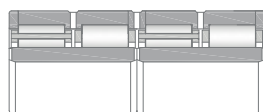
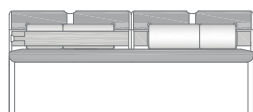
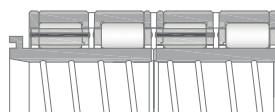
D2C

F2CII/EVO

G2B

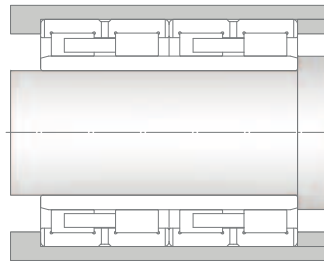
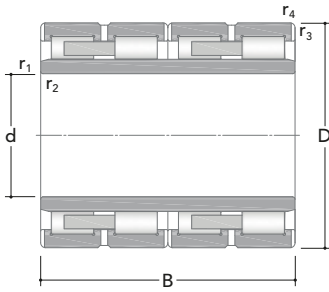
Q2AC

Main dimensions				Basic load ratings		Dimensions		Mass	Designation	
d	D	B	C	Dynamic C	Static C ₀	r _{1,2min}	r _{3,4min}		Cylindrical bore	Tapered bore
[mm]				[kN]		[mm]		[kg]	–	
460	650	470	470	8480	22270	12x20°	3	510	314560	–
	650	470	470	8480	22270	3	3	510	319155	–
	680	400	400	7910	17080	6	6	640	322374	–
475	600	368	368	5330	14590	3	3	235	326261	–
480	650	450	450	8000	20780	12,5x20°	2	440	316690	–
	680	420	420	8150	19070	12x20°	3	515	319320	–
	680	500	500	8890	21650	13x20°	3	605	316624	–
	680	500	500	9240	23530	13x20°	3	585	313516	–
485	740	540	540	10750	28150	5	5	830	–	315523
487,980	637,045	350	350	4920	15170	10,5x20°	4	300	326196	–
500	650	260	260	3890	10090	5	5	225	319254	–
	670	450	450	8070	21970	12,5x20°	5	460	316083	–
	670	480	450	7950	21880	12,5x20°	5	485	322039	–
	680	450	450	8020	21610	5	2	500	316515	–
	710	480	480	8480	21460	18x20°	5	610	316968	–
	720	400	400	7660	17570	6	3	530	322066	–
	720	530	530	10390	28000	13x20°	5	730	314441	–
	738	500	500	10390	23030	1E0(20°	6	735	326853	–
510	680	500	500	8610	25480	7,5x20°	5	522	319411	–
511,584	760	560	580	11640	34290	3	5,8x45°	915	–	457956
529,910	870	670	670	15340	33400	7,5	7,5	1660	312844	–
530	760	520	520	11430	28120	12x20°	5	775	314886	–
	780	500	500	8990	20030	6	6	805	315040	–
	780	570	570	12460	31970	14x20°	3	960	314517	–
536,176	762,030	558,800	558,800	10990	28540	16x20°	4	830	313535	–
	762,030	558,800	558,800	10780	29470	16x20°	4	820	322142	–
549,850	740	510	510	9780	26690	15x20°	2	615	326897	–
550	740	510	510	9730	26570	15x20°	2	615	316691	–

Multi row cylindrical roller bearings



AF2D/A2D

Main dimensions				Basic load ratings		Dimensions		Mass	Designation	
d	D	B	C	Dynamic C	Static C ₀	r _{1,2min}	r _{3,4min}		Cylindrical bore	Tapered bore
[mm]				[kN]		[mm]		[kg]	-	-
550	800	520	520	11310	26160	10x20°	6	895	316115	-
	800	560	560	11670	27580	18,5x20°	6	930	322719	-
551,667	830	580	580	11930	32170	3	6,1x45°	1070	-	457960
559,840	920	710	710	19300	44600	20x20°	4	2000	313189	-
560	820	600	600	13650	33720	20x20°	3	1080	322930	-
571,100	812,970	594	594	13110	33120	14x20°	5	1000	313499	-
571,627	870	640	640	13120	40070	3	4	1335	-	319446
571,667	870	640	640	17330	49430	4	6,4x45°	1170	-	457962
580	780	521	486	9690	26990	12x20°	2	700	326140	-
600	820	575	575	12620	35790	15x20°	3	910	315175	-
	870	540	540	12730	31330	22x20°	4	1100	315068	-
	870	578	540	12780	31440	19,5x20°	4	1150	322497	-
	870	640	640	14660	39700	17x20°	4	1300	314317	-
	870	640	640	15270	39700	20x20°	4	1340	315513	-
606,667	920	640	640	15880	44660	4	5	1525	-	315526
610	820	430	430	9090	23430	19x20°	3	650	315257	-
628	922	600	600	15850	38640	17,5x20°	6	1420	315071	-
633,334	960	680	680	14140	44330	4	6,4x45°	1675	-	457969
634,500	901,870	674	674	16270	44480	18x20°	4	1400	313705	-
650	920	670	670	16590	46250	17x20°	4	1450	313007	-
658	1075	650	650	20000	42820	22x20°	75	2490	320525	-
660	820	440	440	7230	22500	7,5	4	530	239509	-
	880	450	450	6940	23200	6	6	785	313477	-
680	980	640	640	16660	43510	20x20°	4	1590	313154	-

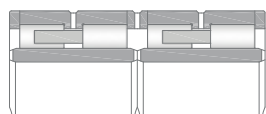

D2C

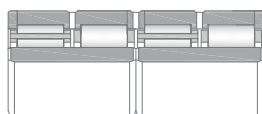

F2CII/EVO

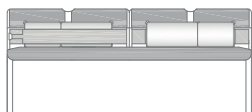

G2B

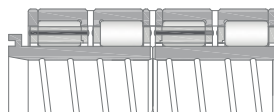

Q2AC

Main dimensions				Basic load ratings		Dimensions		Mass	Designation	
d	D	B	C	Dynamic C	Static C ₀	r _{1,2min}	r _{3,4min}		Cylindrical bore	Tapered bore
[mm]				[kN]		[mm]		[kg]	–	
690	980	715	715	19120	53780	20x20°	4	1780	313008	–
700	930	620	620	14690	42700	18x20°	3	1180	316967	–
710	1000	715	715	19300	54900	17x20°	4	1860	313403	–
730	960	620	620	15060	44920	20x20°	3	1220	315982	–
	1030	750	750	20220	57760	21x20°	6	2040	314518	–
748	1135	690	690	21280	50880	21x20°	4	2635	420625	–
750	1000	500	500	11850	32950	6	6	1150	314420	–
	1000	670	670	17160	49260	20x20°	3	1480	315973	–
759	1210	740	740	24680	83980	4	4	3480	313685	–
760	1080	790	790	23280	64730	7,5	7,5	2440	312979	–
761,425	1079,602	787,400	787,400	23010	65310	19x20°	7,5	2400	312967	–
	1079,602	787,400	787,400	22770	65330	19x20°	75	2410	322143	–
773,334	1120	800	800	23010	64650	4	8,5x45°	2715	–	319991
799	1080	700	700	19100	57610	20x20°	3	1955	326892	–
800	1080	700	700	19050	58060	20x20°	3	1950	315599	–
811,692	1180	850	850	24430	66860	1,5	8,5x45°	2980	–	457984
820	1100	745	720	19120	56190	22x20°	3	2000	316341	–
	1130	800	800	23570	67600	23x20°	6	2540	320455	–
820	1130	825	800	23320	66900	23x20°	6	2570	319313	–
850	1150	840	840	24740	74630	23x20°	4	2570	315826	–
862,980	1219,302	876,300	889	29560	85370	7,5	4	3470	312966	–
865	1180	750	750	22720	66020	20x20°	8,5x45°	2520	319668	–
900	1220	840	840	25790	78970	24x24°	4	3060	316043	–

Multi row cylindrical roller bearings

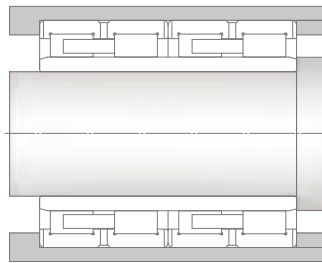
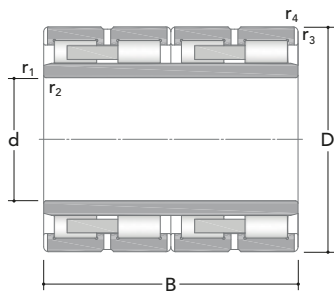

AF2D/A2D

Main dimensions				Basic load ratings		Dimensions		Mass	Designation	
d	D	B	C	Dynamic C	Static C ₀	r _{1,2min}	r _{3,4min}		Cylindrical bore	Tapered bore
[mm]				[kN]		[mm]		[kg]	–	–
900	1280	930	930	32190	91670	25x20°	4	4080	313528	–
918,354	1330	950,125	950	25410	84380	6	6x45°	4380	–	457995
937,500	1270,250	825,500	825,500	27500	82070	27x20°	4	3160	315265	–
950	1360	975	975	32920	98550	26x20°	6	4900	319862	–
	1360	1000	1000	37090	109500	22x20°	5	5020	314520	–
	1360	1000	1000	37090	109500	4	5	4830	–	314520 K30
980	1310	880	880	27760	84840	20x20°	14x45°	3310	319303	–
1000	1360	800	800	26930	82950	23x20°	4	3560	316234	–
1200	1590	1050	1050	40940	132600	30x20°	6	5970	315494	–

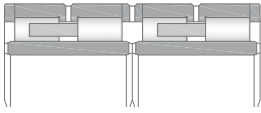

D2C

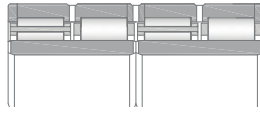

F2CII/EVO

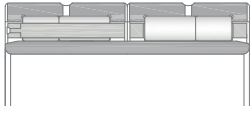

G2B

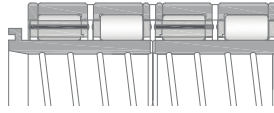

Q2AC



Tapered roller bearings

Tapered roller bearings	145
Single row tapered roller bearings.....	145
Internal clearance and preload	145
Adjustment and running in	145
Misalignment.....	146
Minimum load	146
Designs and variants	148
Type TS.....	148
Type DB.....	148
Type DF	148
Suffixes.....	149
Part numbering.....	150
Inch size.....	150
Metric size	153
Product tables.....	155
Double row tapered roller bearings.....	183
Misalignment.....	183
Minimum load.....	183
Designs and variants	184
Type TDO.....	184
Type TDI	184
Type TDONSAW.....	184
Type TDIS.....	184
Type TDISS.....	185
Suffixes.....	186
Part numbering.....	187
First system	187
Second system.....	189
Product tables.....	191
Four-row tapered roller bearings.....	207
Bearing internal clearance.....	207
Minimum load.....	207

Designs and variants	208
Type TQO ₁	208
Type TQO ₂	208
Type TQO ₃	208
Type SET2xTDI.....	208
Type TQIT.....	209
Type TQOT	209
Type TQOS ₁	209
Type TQOS ₂	209
Type TQOS ₃	210
Suffixes.....	211
Part numbering.....	213
First system	213
Second system.....	215
Product tables	217

RKB
BEARING INDUSTRIES
SWITZERLAND

Tapered roller bearings

The tapered roller bearings manufactured by RKB are engineered to withstand combined radial and thrust loads. Available in a rich portfolio of designs and sizes, in standardized and non-standardized dimensional series, RKB tapered roller bearings can be in metric or inch measurements and represent the state of the art. Manufactured from high hardness materials, featuring unparalleled fatigue strength and resistance to wear, RKB TRBs provide excellent performance even under severe operating conditions.

RKB's single row, matched pair, double and four-row tapered roller bearings are optimized to ensure increased load carrying capacities and high stiffness in special applications. RKB Bainite Hardening Treatment (HB) and High Temperature Dimensional Stabilization (S) can be applied on bearing rings and rollers.

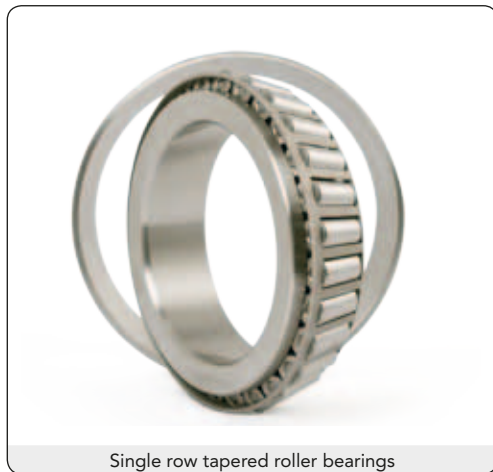

Single row tapered roller bearings

RKB single row and matched pair tapered roller bearings (SRTRBs) are widely used in all industrial segments, in standard and critical applications. The tighter dimensional tolerances, obtained through an extremely high precision manufacturing technology, and the optimized inner geometry (E-Type class) make of such bearings a reliable solution to improve the performance of any machine. Naturally, the matched pairs can be assembled according to the customer's special needs (e.g. a given axial internal clearance). The bearing dimensional and running accuracy conforms to ISO/ABMA/GOST specifications.

Internal clearance and preload

The internal axial load or preload of the single row taper roller bearing can be obtained only during the mounting by adjusting one bearing against to the second one, which guarantees the location on the opposite side.

For standard internal clearance of paired metric single row tapered roller bearings in face-to-face or back-to-back arrangement please see **Tab. 1 page 147**.

Adjustment and running in

Before adjusting the taper roller bearings against each other, it is mandatory to rotate them in order to permit the rollers to find their final position. During the running-in, the working temperature of the taper roller bearings will increase rapidly due to the high frictional moment, but when the running-in period will be completed the temperature becomes stable and the thermal equilibrium takes place.

Misalignment

The permissible misalignment between the shaft and seat of the single row tapered roller bearing is restricted to a few minutes of arc, approximately from 2 to 4 minutes of arc.

These values can be considered valid if the shaft and housing axes remain unchanged. Larger values of misalignment may be used, but with negative consequences regarding the bearing life. For additional information, please consult the RKB application engineering service.

Minimum load

A minimum radial load is requested for single tapered roller bearings, like for all ball and roller bearings, in order to guarantee an adequate operation condition, especially in critical working conditions: high speed ($n > 0.5$ reference speed), high acceleration and sudden changes of rotating direction. In these operating conditions a sliding movement between the rollers and raceways can be generated by the inertial forces, influencing negatively the bearing life. Minimum radial load can be calculated using the following formula:

$$\frac{F_{rm}}{C_r} > 0,02$$

Where

- F_{rm} minimum radial load, [kN];
- C_r basic dynamic radial load, [kN].

Usually, the minimum radial load is reached or surpassed by the weight of the components supported by the bearing and the loads acting on it, otherwise supplementary radial load must be applied on the single row tapered roller bearing. In application where a starting up at low temperature is planned or a lubricant with high viscosity is used, a greater minimum radial load is required.

Tapered roller bearings

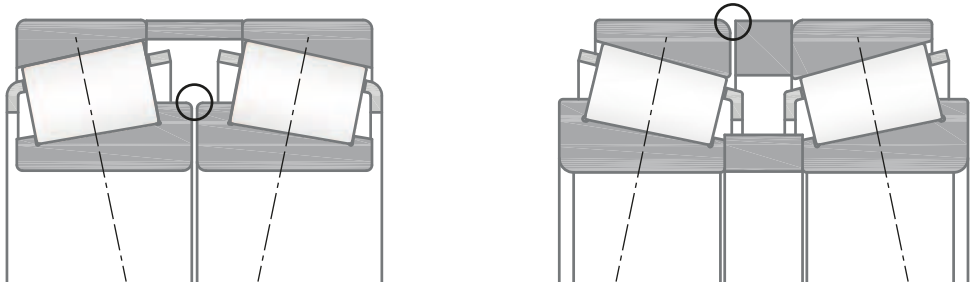

Bore diameter		Axial internal clearance of matched bearings in the series											
d		329		320		330		331, 302, 322, 332		303, 323		313	
over	incl.	high	low	high	low	high	low	high	low	high	low	high	low
[mm]		[μm]											
-	30	-	-	80	120	-	-	100	140	130	170	60	100
30	40	-	-	100	140	-	-	120	160	140	180	70	110
40	50	-	-	120	160	180	220	140	180	160	200	80	120
50	65	-	-	140	180	200	240	160	200	180	220	100	140
65	80	-	-	160	200	250	290	180	220	200	260	110	170
80	100	270	310	190	230	350	390	210	270	240	300	110	170
100	120	270	330	220	280	340	400	220	280	280	340	130	190
120	140	310	370	240	300	340	400	240	300	330	390	160	220
140	160	370	430	270	330	340	400	270	370	370	430	180	240
160	180	370	430	310	370	-	-	310	370	390	450	-	-
180	190	370	430	340	400	-	-	340	400	440	500	-	-
190	200	390	450	340	400	-	-	340	400	440	500	-	-
200	225	440	500	390	450	-	-	390	450	490	550	-	-
225	250	440	500	440	500	-	-	440	500	540	600	-	-
250	280	540	600	490	550	-	-	490	550	-	-	-	-
280	300	640	700	540	600	-	-	540	600	-	-	-	-
300	340	640	700	590	650	-	-	590	650	-	-	-	-

Tab. 1 - Axial internal clearance of paired metric single row tapered roller bearings in face-to-face or back-to-back arrangement

Designs and variants

Type TS

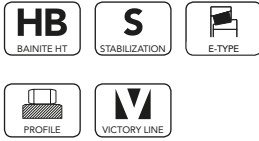
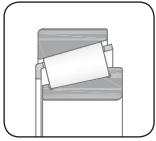

- Ribless outer ring (cup)
- Inner ring with two integral ribs (cone)
- One-piece window type pressed steel cage
- Supports radial and axial loads in one direction
- Suitable for medium to high operating speeds
- Separable design
- Optimized geometry (E-Type)
- Optimized roller profile
- Available in metric and inch sizes

Type DF

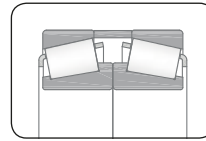

- Matched set of single row TRBs (face-to-face arrangement)
- Available with cup and cone spacers (plain or with lubrication holes)
- Supports radial and axial loads in both directions
- Low arrangement stiffness
- Increased angular misalignment
- Optimized geometry (E-Type)
- Optimized roller profile
- Preset or adjusted BEP on customer's request
- Available in metric and inch sizes

Type DB

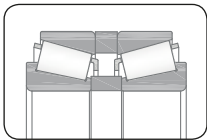

- Matched set of single row TRBs (back-to-back arrangement)
- Available with cup and cone spacers (plain or with lubrication holes)
- Supports radial and axial loads in both directions
- High arrangement stiffness
- Reduced angular misalignment
- Optimized geometry (E-Type)
- Optimized roller profile
- Preset or adjusted BEP on customer's request
- Available in metric and inch sizes

Tapered roller bearings

Suffixes	Internal design
A	Standard contact angle
B	Steep contact angle
SP	Special or non-standard bearing
BT1B	Single row tapered roller bearing
C	Cone with boundary dimensions same as basic part number but modified inner geometry
E	Optimized inner geometry
DRW	Special or non-standard bearing
ZB	Optimized roller profile for improved load distribution. It is not necessarily stated in the bearing code

Suffixes	Cage
J	Pressed steel cage

Suffixes	Accuracy, clearance, running
CL0 or CLN	Dimensional and running accuracy to ISO tolerance class 0 or normal
CL2	Dimensional and running accuracy to ISO tolerance class 2
CL3	Dimensional and running accuracy to ISO tolerance class 3
CL4	Dimensional and running accuracy to ISO tolerance class 4

Suffixes	External design
N1 or W	One locating slot in cup
N2 or W	Two locating slots in cup

Suffixes	Set
DB	Two bearings matched for mounting back-to-back
DF	Two bearings matched for mounting face-to-face
DT	Two bearings matched for mounting in tandem
DB...	Two bearings matched for mounting back-to-back. The number immediately following the DB identifies the design of the spacers
DF...	Two bearings matched for mounting face-to-face. The number immediately following the DF identifies the design of the spacers

Suffixes	Alternative designation
TS	Out of standard single row tapered roller bearing followed by drawing number

Part numbering

Several part-numbering systems have been developed in the last 70 years for tapered roller bearings. Inch size bearings are usually given individual part numbers for the cone and the cup, while ISO metric bearings are identified by means of a unique part number for the bearing assembly as a whole.

Inch size

Original system

	Section 1	Section 2	Section 3
	Prefix	Numerical code	Suffix
Example	EE	107060/107105	C

Tab. 2 - Original system: structure

Prefix	Component	Description
-	Cone and cup	-
A	Cone and cup	Part of the standard basic series number
EE	Cone	Large and small ribs close guided rollers. It was originally used to designate close guided rollers. Even if this designation is no longer in use, the prefix has been maintained on existing part numbers
NA	Cone	Non-adjustable. Two single cones with front faces contacting, mated with a double cup to form a double row bearing with internal clearances preset
J	Cone and cup	A J preceding the prefix or numerical code indicates a metric design bearing component

Tab. 3 - Original system: prefixes

ABMA system

	Section 1	Section 2	Section 3	Section 4	Section 5
	Duty class	Angularity	Basic series	Component	Suffix
Example	HM	3	226	49	C

Tab. 4 - ABMA system: structure

Tapered roller bearings

Prefix	Component
EL	Extra Light
LL	Lighter than Light
L	Light
LM	Light Medium
M	Medium
HM	Heavy Medium
H	Heavy
HH	Heavier than Heavy
EH	Extra Heavy
T	Thrust only
J	Metric size
-	Different prefixes or absence of prefixes indicates original inch part numbering system

Tab. 5 - ABMA system: duty class

Cup angle		Code
over	incl.	
0	to 23° 59' 59,99"	1
24°	to 25° 29' 59,99"	2
25° 30'	to 26° 59' 59,99"	3
27°	to 28° 29' 59,99"	4
28° 30'	to 30° 29' 59,99"	5
30° 30'	to 32° 29' 59,99"	6
32° 30'	to 35° 59' 59,99"	7
36°	to 44° 59' 59,99"	8
45°	Up, but not thrust only	9
90°	Thrust only	0

Tab. 6 - ABMA system: angularity

Series indication	Maximum bore range [mm]		Maximum bore range [inches]	
	over	incl.	over	incl.
0-9 incl.	Extremely small tapered roller bearings			
00-19 incl.	0	25,4	0	1
20-99 incl.	25,4	50,8	1	2
000-029 incl.				
039-129 incl.	50,8	76,2	2	3
130-189 incl.	76,2	101,6	3	4
190-239 incl.	101,6	127,0	4	5
240-289 incl.	127,0	152,4	5	6
290-339 incl.	152,4	177,8	6	7
340-389 incl.	177,8	203,2	7	8
390-429 incl.	203,2	228,6	8	9
430-469 incl.	228,6	254,0	9	10
470-509 incl.	254,0	279,4	10	11
510-549 incl.	279,4	304,8	11	12

Tab. 7 (1 of 2) - ABMA system: basic series

Series indication	Maximum bore range [mm]		Maximum bore range [inches]	
	over	incl.	over	incl.
550-579 incl.	304,8	330,2	12	13
580-609 incl.	330,2	355,6	13	14
610-639 incl.	355,6	381,0	14	15
640-659 incl.	381,0	406,4	15	16
660-679 incl.	406,4	431,8	16	17
680-699 incl.	431,8	457,2	17	18
695-709 incl.	457,2	482,6	18	19
710-724 incl.	482,6	508,0	19	20
725-739 incl.	508,0	534,4	20	21
740-754 incl.	534,4	558,8	21	22
755-769 incl.	558,8	584,2	22	23
770-784 incl.	584,2	609,6	23	24
785-799 incl.	609,6	635,0	24	25
800-829 incl.	635,0	762,0	25	30
830-859 incl.	762,0	889,0	30	35
860-879 incl.	889,0	1016,0	35	40
880-889 incl.	1016,0	1270,0	40	50
890-899 incl.	1270,0	1841,5	50	72,5
900-999 incl.	Extremely large tapered roller bearings			

Tab. 7 (2 of 2) - ABMA system: basic series

Component	Component number
Cups	10-19 (maximum section)
Cones	30-49 (minimum section)

Tab. 8 - Component

Tapered roller bearings

Metric size

First system

The J prefix placed at the beginning of an ABMA bearing code identifies metric dimensioned and toleranced cones and cups.

	Section 0	Section 1	Section 2	Section 3	Section 4	Section 5
	Prefix	Duty class	Angularity	Basic series	Component	Suffix
Example	J	HM	3	226	49	C

Tab. 9 - Metric system: structure

ISO 15 system

	Section 1	Section 2	Section 3	Section 4	Section 5
	Bearing type	Width series	Diameter series	Bore indication	Suffix
Example	3	2	2	18	C

Tab. 10 - ISO 15 system: structure

ISO 355 system

	Section 1	Section 2	Section 3	Section 4	Section 5	Section 6
	Prefix (none or T)	Contact angle series (alpha)	Diameter series	Width series	Bore diameter	Suffix
Example	T	4	E	B	240	C

Tab. 11 - ISO 15 system: structure

Designation of contact angle series (alpha)	Alpha	
	over	incl.
1	Reserved for future use	
2	10°	13° 52'
3	13° 52'	15° 59'
4	15° 59'	18° 55'
5	18° 55'	23°
6	23°	27°
7	27°	30°

Tab. 12 - ISO 355 system: contact angle series (alpha)

Designation of diameter series	D/d ^{0,77}	
	over	incl.
A	Reserved for future use	
B	3,4	3,8
C	3,8	4,4
D	4,4	4,7
E	4,7	5
F	5	5,6
G	5,6	7

Tab. 13 - ISO 355 system: diameter series

Designation of width series	T/(D-d) ^{0,95}	
	over	incl.
A	Reserved for future use	
B	0,5	0,68
C	0,68	0,8
D	0,8	0,88
E	0,88	1

Tab. 14 - ISO 355 system: width series

Optimized bearing system

The J prefix identifies metric dimensioned and toleranced cones and cups.

	Section 0	Section 1	Section 2	Section 3	Section 4
	Prefix	Duty class	Bore diameter	Component	Suffix
Example	J	P	130	49	A

Tab. 15 - Optimized bearing system: structure

Duty class	Application
C, D, F	General purpose
N	Combination of general purpose and pinion
P	High speed
S, T	Pinion
W	High axial loads

Tab. 16 - Optimized bearing system: duty class

Single row tapered roller bearings - Metric

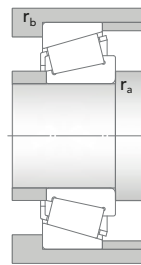
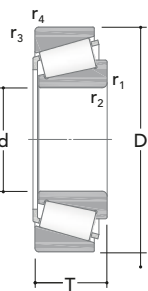

TS

Main dimensions			Basic load ratings		Speed ratings		Dimensions				Mass	Designation
d	D	T	Dynamic C	Static C ₀	Reference	Limiting	r _{1,2min}	r _{3,4min}	r _{amax}	r _{bmax}		
[mm]			[kN]		[rpm]		[mm]				[kg]	-
15	42	14,25	21,7	20,0	12500	15200	1	1	1	1	0,094	30302
17	40	13,25	18,6	18,4	12700	15600	1	1	1	1	0,079	30203
	47	15,25	27,1	24,8	11500	13600	1	1	1	1	0,13	30303
	47	20,25	33,9	33,4	10700	13400	1	1	1	1	0,17	32303
20	42	15	23,7	26,7	11700	13200	0,6	0,6	0,6	0,6	0,098	32004
	47	15,25	26,9	27,6	10700	12800	1	1	1	1	0,12	30204
	52	16,25	32,8	32,2	10500	11600	1,5	1,5	1,5	1,5	0,17	30304
	52	22,25	42,5	44,8	9600	11900	1,5	1,5	1,5	1,5	0,23	32304
22	44	15	24,4	28,5	10700	12900	0,6	0,6	0,6	0,6	0,1	320/22
25	47	15	26,2	32,2	10600	11700	0,6	0,6	0,6	0,6	0,11	32005
	52	16,25	29,9	33,5	9600	11000	1	1	1	1	0,15	30205
	52	19,25	34,8	43,2	9200	11200	1	1	1	1	0,19	32205
	52	22	46,2	55,3	8700	10800	1	1	1	1	0,22	33205
	62	18,25	43,5	42,8	8700	10100	1,5	1,5	1,5	1,5	0,26	30305
	62	18,25	37,2	39,5	7300	9200	1,5	1,5	1,5	1,5	0,27	31305
28	62	25,25	58,9	62,0	7700	10200	1,5	1,5	1,5	1,5	0,36	32305
	52	16	30,8	37,5	9100	10700	1	1	1	1	0,14	320/28
	58	17,25	36,6	41,2	8600	10300	1	1	1	1	0,2	302/28
30	58	20,25	40,6	49,5	8200	10300	1	1	1	1	0,25	322/28
	55	17	35,0	43,5	8800	10000	1	1	1	1	0,17	32006
	62	17,25	38,8	43,8	8200	9500	1	1	1	1	0,23	30206
	62	21,25	48,7	55,9	8200	9400	1	1	1	1	0,29	32206
	62	25	62,0	75,2	7200	9000	1	1	1	1	0,35	33206
	72	20,75	54,0	55,5	7200	8400	1,5	1,5	1,5	1,5	0,38	30306
	72	20,75	45,8	49,9	6400	7800	1,5	1,5	1,5	1,5	0,39	31306
32	72	28,75	73,9	83,8	6700	8600	1,5	1,5	1,5	1,5	0,55	32306
	53	14,5	26,4	35,5	8800	10700	3,6	1,3	3	1,3	0,11	JL 26749 F/710
	58	17	36,0	45,8	8200	9200	1	1	1	1	0,19	320/32
35	62	18	35,9	48,1	7600	9100	1	1	1	1	0,23	32007
	72	18,25	49,8	55,0	6800	8000	1,5	1,5	1,5	1,5	0,33	30207
	72	24,25	64,1	76,5	6700	7900	1,5	1,5	1,5	1,5	0,44	32207
	72	28	81,7	105	6100	8100	1,5	1,5	1,5	1,5	0,53	33207
	80	22,75	69,7	72,5	6400	7400	2	1,5	2	1,5	0,51	30307

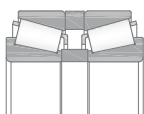
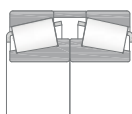

DB

DF

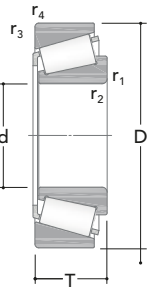
Main dimensions			Basic load ratings		Speed ratings		Dimensions				Mass	Designation
d	D	T	Dynamic C	Static C ₀	Reference	Limiting	r _{1,2min}	r _{3,4min}	r _{amax}	r _{bmax}		
[mm]			[kN]		[rpm]		[mm]				[kg]	-
35	80	22,75	59,4	66,0	5700	7000	2	1,5	2	1,5	0,52	31307
	80	32,75	90,6	114	5800	7200	2	1,5	2	1,5	0,8	32307
37	80	32,75	90,2	112	6000	7800	2	1,5	2	1,5	0,77	32307/37
38	63	17	35,4	51,0	7200	9200	1,3	1,3	1,3	1,3	0,21	JL 69349 A/310
	68	19	51,6	70,8	6800	8300	1	1	1	1	0,3	32008/38
40	68	19	50,8	70,4	6700	7800	1	1	1	1	0,28	32008
	75	26	76,9	102	6500	7400	1,5	1,5	1,5	1,5	0,5	33108
	80	19,75	59,5	67,0	6000	7100	1,5	1,5	1,5	1,5	0,42	30208
	80	24,75	73,3	86,5	6100	7300	1,5	1,5	1,5	1,5	0,53	32208
	80	32	101	130	5300	7300	1,5	1,5	1,5	1,5	0,73	33208
	85	33	118	147	5800	7400	1	2	1	2	0,9	T2EE 040
	90	25,25	83,7	93,7	5800	6600	2	1,5	2	1,5	0,73	30308
	90	25,25	81,6	80,7	5300	6400	2	1,5	2	1,5	0,72	31308
45	90	35,25	113	139	5100	6900	2	1,5	2	1,5	1,05	32308
	75	20	56,6	79,3	6100	7000	1	1	1	1	0,34	32009
	80	26	92,8	112	6400	6800	1,5	1,5	1,5	1,5	0,55	33109
	85	20,75	63,6	76,0	5700	6500	1,5	1,5	1,5	1,5	0,47	30209
	85	24,75	89,6	97,9	6100	6900	1,5	1,5	1,5	1,5	0,58	32209
	85	32	104	142	5000	6200	1,5	1,5	1,5	1,5	0,79	33209
	95	29	86,2	110	4600	5800	2,5	2,5	2,5	2,5	0,93	T7FC 045
	95	36	143	183	5100	6900	2,5	2,5	2,5	2,5	1,2	T2ED 045
	100	27,25	105	118	5100	6000	2	1,5	2	1,5	0,97	30309
	100	27,25	103	101	4800	5500	2	1,5	2	1,5	0,95	31309
46	100	38,25	137	168	4600	5900	2	1,5	2	1,5	1,4	32309
	75	18	49,0	70,1	6100	8200	2,3	1,6	2,3	1,5	0,3	LM 503349/310
50	80	20	58,8	87,3	5800	6500	1	1	1	1	0,38	32010
	80	24	67,8	102	5800	6800	1	1	1	1	0,45	33010
	82	21,5	70,6	99,9	5800	7000	3,6	1,2	3,4	1,2	0,43	JLM 104948 AA/910
	85	26	82,6	120	5300	6400	1,5	1,5	1,5	1,5	0,58	33110
	90	21,75	74,6	91,0	5400	6400	1,5	1,5	1,5	1,5	0,54	30210
	90	24,75	80,5	99,5	5400	6300	1,5	1,5	1,5	1,5	0,62	32210
	90	28	104	138	5100	6800	3	2,5	2,5	0,8	0,75	JM 205149/110
	90	32	112	158	4800	5900	1,5	1,5	1,5	1,5	0,86	33210
	100	36	149	198	4800	6200	2,5	2,5	2,5	2,5	1,3	T2ED 050
	105	32	105	136	4100	5400	3	3	2,5	2,5	1,25	T7FC 050

Single row tapered roller bearings - Metric

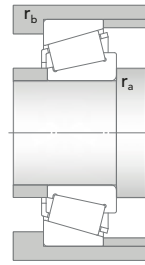

TS



Main dimensions			Basic load ratings		Speed ratings		Dimensions				Mass	Designation
d	D	T	Dynamic C	Static C ₀	Reference	Limiting	r _{1,2min}	r _{3,4min}	r _{amax}	r _{bmax}		
[mm]			[kN]		[rpm]		[mm]				[kg]	-
50	110	29,25	138	138	5100	5400	2,5	2	2,5	2	1,25	30310
	110	29,25	118	118	4300	5100	2,5	2	2,5	2	1,2	31310
	110	42,25	178	215	4300	5000	2,5	2	2,5	2	1,95	32310
55	90	23	77,8	114	5000	5800	1,5	1,5	1,5	1,5	0,56	32011
	90	27	101	135	5400	5900	1,5	1,5	1,5	1,5	0,66	33011
	95	30	108	156	4800	5500	1,5	1,5	1,5	1,5	0,85	33111
	100	22,75	100	105	5000	5500	2	1,5	2	1,5	0,7	30211
	100	26,75	103	127	4800	5500	2	1,5	2	1,5	0,84	32211
	100	35	135	188	4300	5300	2	1,5	2	1,5	1,15	33211
	110	39	175	232	4400	5700	2,5	2,5	2,5	2,5	1,7	T2ED 055
	115	34	121	161	3800	4600	3	3	2,5	2,5	1,6	T7FC 055
	120	31,5	160	160	4600	4700	2,5	2	2,5	2	1,55	30311
	120	31,5	118	137	3700	4600	2,5	2	2,5	2	1,55	31311
	120	45,5	212	260	4200	4800	2,5	2	2,5	2	2,5	32311
60	95	23	91,6	121	5100	5600	1,5	1,5	1,5	1,5	0,59	32012
	95	27	104	141	5100	5800	1,5	1,5	1,5	1,5	0,7	33012
	100	30	113	169	4600	5100	1,5	1,5	1,5	1,5	0,92	33112
	110	23,75	108	112	4800	4900	2	1,5	2	1,5	0,88	30212
	110	29,75	121	159	4300	5100	2	1,5	2	1,5	1,15	32212
	110	38	163	233	3800	5000	2	1,5	2	1,5	1,55	33212
	115	40	187	256	4100	5300	2,5	2,5	2,5	2,5	1,85	T2EE 060
	125	37	150	202	3400	4500	3	3	2,5	2,5	2,05	T7FC 060
	130	33,5	163	192	3800	4400	3	2,5	3	2,5	1,95	30312
	130	33,5	141	163	3500	4300	3	2,5	3	2,5	1,9	31312
	130	48,5	213	301	3400	4100	3	2,5	3	2,5	3,1	32312
65	100	23	93,1	125	4800	5000	1,5	1,5	1,5	1,5	0,63	32013
	100	27	108	152	4800	5400	1,5	1,5	1,5	1,5	0,75	33013
	110	28	119	183	4100	5300	3	2,5	2,8	2,5	1,05	JM 511946/910
	110	31	135	190	4100	5300	2	2	2	2	1,15	T2DD 065
	110	34	138	208	4100	4800	1,5	1,5	1,5	1,5	1,3	33113
	120	24,75	129	132	4300	4700	2	1,5	2	1,5	1,1	30213
	120	32,75	147	192	3900	4700	2	1,5	2	1,5	1,5	32213
	120	41	186	267	3600	4500	2	1,5	2	1,5	2	33213
	130	37	153	215	3300	4200	3	3	2,5	2,5	2,2	T7FC 065
	140	36	188	227	3400	4100	3	2,5	3	2,5	2,45	30313
	140	36	162	191	3100	4000	3	2,5	3	2,5	2,35	31313
140	51	240	340	3100	4100	3	2,5	3	2,5	3,75	32313	

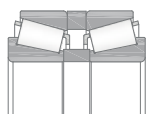

DB

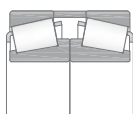

DF

Main dimensions			Basic load ratings		Speed ratings		Dimensions				Mass	Designation
d	D	T	Dynamic C	Static C ₀	Reference	Limiting	r _{1,2min}	r _{3,4min}	r _{amax}	r _{bmax}		
[mm]			[kN]		[rpm]		[mm]				[kg]	-
70	110	25	97,8	153	4100	4800	1,5	1,5	1,5	1,5	0,85	32014
	110	31	127	194	4200	4800	1,5	1,5	1,5	1,5	1,05	33014
	120	37	167	247	3800	4500	2	1,5	2	1,5	1,7	33114
	125	26,25	122	154	3800	4300	2	1,5	2	1,5	1,25	30214
	125	33,25	152	205	3600	4400	2	1,5	2	1,5	1,6	32214
	125	41	197	282	3500	4100	2	1,5	2	1,5	2,1	33214
	130	43	228	322	3700	4700	8	2,5	7	2,5	2,45	T2ED 070
	140	39	172	239	3100	3800	3	3	2,5	2,5	2,65	T7FC 070
	150	38	183	218	2900	3700	3	2,5	3	2,5	2,9	31314
	150	38	213	257	3200	3700	3	2,5	3	2,5	2,95	30314
	150	54	270	396	2800	3600	3	2,5	3	2,5	4,55	32314
75	105	20	67,9	115	4100	5200	1	1	1	1	0,48	32915
	115	25	102	162	3800	4500	1,5	1,5	1,5	1,5	0,91	32015
	115	31	131	228	3900	4400	1,5	1,5	1,5	1,5	1,15	33015
	120	31	134	213	3600	4800	2,5	2,5	2,5	2	1,3	JM 714249/210
	125	37	170	262	3600	4100	2	1,5	2	1,5	1,8	33115
	130	27,25	136	176	3600	4200	2	1,5	2	1,5	1,4	30215
	130	33,25	156	212	3400	4100	2	1,5	2	1,5	1,65	32215
	130	41	202	298	3200	4000	2	1,5	2	1,5	2,2	33215
	145	52	288	441	3300	4100	11	3	11	3	3,9	T3FE 075VB481
	150	42	197	280	2900	3600	3	3	2,5	2,5	3,25	T7FC 075
	160	40	238	289	3000	3500	3	2,5	3	2,5	3,5	30315
	160	40	204	242	2700	3500	3	2,5	3	2,5	3,5	31315
	160	58	327	472	2700	3200	3	2,5	3	2,5	5,55	32315
80	125	29	135	215	3500	4200	1,5	1,5	1,5	1,5	1,3	32016
	125	36	162	283	3400	4300	1,5	1,5	1,5	1,5	1,65	33016
	130	35	172	275	3500	4400	3	2,5	2,8	2,5	1,75	JM 515649/610
	130	37	173	277	3400	4000	2	1,5	2	1,5	1,85	33116
	140	28,25	145	179	3200	4000	2,5	2	2,5	2	1,6	30216
	140	35,25	180	243	3200	3800	2,5	2	2,5	2	2,05	32216
	140	46	242	369	3000	3800	2,5	2	2,5	2	2,9	33216
	160	45	221	311	2700	3300	3	3	2,5	2,5	4	T7FC 080
	170	42,5	216	261	2700	3300	3	2,5	3	2,5	4,05	31316
	170	42,5	260	318	2800	3500	3	2,5	3	2,5	4,15	30316
	170	61,5	369	495	2900	3500	3	2,5	3	2,5	6,2	32316
	85	130	29	136	222	3200	3900	1,5	1,5	1,5	1,5	1,35
130		36	179	309	3500	4000	1,5	1,5	1,5	1,5	1,75	33017
140		41	214	334	3300	3700	2,5	2	2,5	2	2,45	33117

Single row tapered roller bearings - Metric

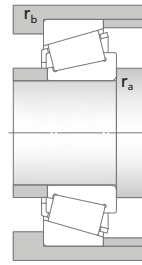
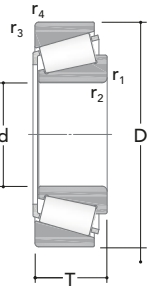

TS

Main dimensions			Basic load ratings		Speed ratings		Dimensions				Mass	Designation
d	D	T	Dynamic C	Static C ₀	Reference	Limiting	r _{1,2min}	r _{3,4min}	r _{amax}	r _{bmax}		
[mm]			[kN]		[rpm]		[mm]				[kg]	-
85	150	30,5	170	218	3000	3500	2,5	2	2,5	2	2,05	30217
	150	38,5	207	284	3100	3500	2,5	2	2,5	2	2,6	32217
	150	49	278	422	2900	3600	2,5	2	2,5	2	3,55	33217
	180	44,5	293	360	2700	3300	4	3	4	3	4,85	30317
	180	44,5	235	280	2500	3200	4	3	4	3	4,6	31317
	180	63,5	381	552	2700	3300	4	3	4	3	7,6	32317
90	140	32	164	266	3100	3500	2	1,5	2	1,5	1,75	32018
	140	39	211	354	3100	3700	2	1,5	2	1,5	2,2	33018
	150	45	241	386	2800	3600	2,5	2	2,5	2	3,1	33118
	160	32,5	190	245	2900	3400	2,5	2	2,5	2	2,5	30218
	160	42,5	243	337	2900	3300	2,5	2	2,5	2	3,35	32218
	190	46,5	319	395	2500	3400	4	3	4	3	5,65	30318
	190	46,5	255	311	2300	2800	4	3	4	3	5,4	31318
	190	67,5	447	608	2500	3300	4	3	4	3	8,4	32318
95	145	32	164	269	3100	3700	2	1,5	2	1,5	1,85	32019
	145	39	212	368	3000	3700	2	1,5	2	1,5	2,3	33019
	170	34,5	209	274	2700	3200	3	2,5	3	2,5	3	30219
	170	45,5	274	384	2700	3200	3	2,5	3	2,5	4,1	32219
	180	49	266	394	2300	2800	4	4	3	3	5,25	T7FC 095/VQ051
	200	49,5	318	384	2500	2800	4	3	4	3	6,45	30319
	200	49,5	283	355	2300	2900	4	3	4	3	6,3	31319
	200	71,5	487	665	2300	2900	4	3	4	3	9,8	32319
100	140	25	115	201	3000	3900	1,5	1,5	1,5	1,5	1,15	32920
	145	24	120	189	3000	3700	3	3	2,5	2,5	1,2	T4CB 100
	150	32	167	278	2900	3200	2	1,5	2	1,5	1,9	32020
	150	39	218	387	2900	3400	2	1,5	2	1,5	2,4	33020
	155	32	168	276	1900	2500	2,5	2,5	2,5	2,5	2,20	332118
	157	42	239	393	2900	3600	8	3,5	7	3,3	2,9	HM 220149/110
	157	42	237	393	2800	3700	3	3,5	3	3	2,95	328115
	160	41	239	386	2700	3500	3	2,5	2,8	2,5	3,05	JHM 720249/210
	165	47	302	471	2600	3600	3	3	2,5	2,5	3,9	T2EE 100
	180	37	237	318	2600	3000	3	2,5	3	2,5	3,6	30220
	180	49	309	440	2500	3000	3	2,5	3	2,5	4,95	32220
	180	63	414	645	2300	3100	3	2,5	3	2,5	6,7	33220
	215	45	245	310	1400	1700	3	3	2,5	2,5	6,50	BT1B 328180
	215	51,5	389	488	2300	2700	4	3	4	3	7,95	30320
	215	56,5	363	456	2100	2400	4	3	4	3	8,6	31320J2
215	77,5	553	770	2100	2700	4	3	4	3	12,5	32320	

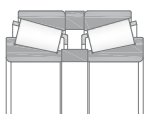

DB

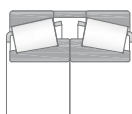

DF

Main dimensions			Basic load ratings		Speed ratings		Dimensions				Mass	Designation
d	D	T	Dynamic C	Static C ₀	Reference	Limiting	r _{1,2min}	r _{3,4min}	r _{amax}	r _{bmax}		
[mm]			[kN]		[rpm]		[mm]				[kg]	-
105	160	35	195	329	2700	3100	2,5	2	2,5	2	2,45	32021
	160	43	240	428	2700	3100	2,5	2	2,5	2	3	33021
	160	43	237	427	1800	2300	2,5	2	2	2	3,05	33021
	190	39	263	353	2500	2800	3	2,5	3	2,5	4,3	30221
	190	53	348	505	2500	2800	3	2,5	3	2,5	6,05	32221
	225	53,5	413	526	1500	1800	4	3	2,5	2,5	9,15	30321
	225	81,5	591	804	1900	2500	4	3	4	3	14	32321
106	160	35	193	332	1800	2300	6,4	2	6	2	2,30	331974
110	150	25	121	223	2900	3700	1,5	1,5	1,5	1,5	1,25	32922
	160	27	147	230	1800	2300	3	3	2,5	2,5	1,60	T4CB 110
	170	38	227	385	2500	3100	2,5	2	2,5	2	3,05	32022
	170	47	275	494	2500	3000	2,5	2	2,5	2	3,85	33022
	180	47	308	518	1700	2200	3	2,5	2,5	2	4,65	JHM 522649/JHM 522610
	180	56	356	620	2500	2800	2,5	2	2,5	2	5,5	33122
	200	41	300	399	2300	2700	3	2,5	3	2,5	5,05	30222
	200	56	393	563	2300	2700	3	2,5	3	2,5	7,1	32222
	240	48	285	362	1300	1500	3	3	2,5	2,5	8,45	BT1B 328164
	240	54,5	456	576	2100	2300	4	3	4	3	11	30322
	240	63	440	580	1800	2300	4	3	4	3	12	31322J2
240	84,5	604	824	1800	2300	4	3	4	3	16,5	32322	
120	165	29	161	303	2500	3200	1,5	1,5	1,5	1,5	1,8	32924
	170	27	151	248	2500	3200	3	3	2,5	2,5	1,75	T4CB 120
	170	27	130	224	1600	2000	5	2,5	4	2,5	1,80	BT1B 328031
	180	38	237	410	2300	2900	2,5	2	2,5	2	3,3	32024
	180	48	286	534	2500	2800	2,5	2	2,5	2	4,15	33024
	215	43,5	330	460	2100	2500	3	2,5	3	2,5	6,1	30224
	215	61,5	457	693	2100	2400	3	2,5	3	2,5	9,05	32224
	260	59,5	539	696	1900	2100	4	3	4	3	13,5	30324
	260	68	525	690	1600	1900	4	3	4	3	15,5	31324
	260	90,5	761	1090	1700	2200	4	3	4	3	21,5	32324
	130	180	32	193	362	2300	2900	2	1,5	2	1,5	2,4
185		29	187	310	1600	2000	3	3	2	2,5	2,25	T4CB 130
200		45	304	539	2100	2500	2,5	2	2,5	2	4,95	32026
220		64	477	745	1500	1800	3	3	2,5	2,5	9,40	BT1B 442768
230		43,75	362	485	1900	2300	4	3	4	3	6,85	30226
230		64	497	721	1400	1700	3	2,5	2,5	2,5	10,50	BT1B 443742
230		67,75	537	827	1900	2300	4	3	4	3	11	32226

Single row tapered roller bearings - Metric

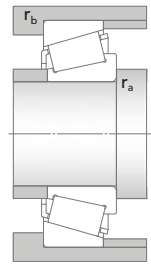
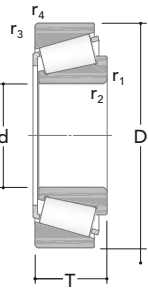

TS

Main dimensions			Basic load ratings		Speed ratings		Dimensions				Mass	Designation
d	D	T	Dynamic C	Static C ₀	Reference	Limiting	r _{1,2min}	r _{3,4min}	r _{amax}	r _{bmax}		
[mm]			[kN]		[rpm]		[mm]				[kg]	-
130	280	63,75	606	797	1700	1900	5	4	5	4	17	30326
	280	72	582	773	1500	2000	5	4	5	4	18,5	31326
	280	98,75	838	1160	1000	1300	5	4	3	3	30,50	32326
140	190	32	200	388	2100	2800	2	1,5	2	1,5	2,55	32928
	195	29	187	323	2100	2700	3	3	2,5	2,5	2,4	T4CB 140
	210	45	319	582	2100	2300	2,5	2	2,5	2	5,25	32028
	250	45,75	409	564	1800	2100	4	3	4	3	8,7	30228
	250	71,75	630	988	1800	2200	4	3	4	3	14	32228
	300	63,5	624	1000	1000	1300	7	3,3	6	3	21,50	440740
	300	67,75	717	934	1100	1400	5	4	3	3	21,00	30328
	300	77	669	896	1400	1800	5	4	5	4	22,00	31328
150	210	32	227	384	1900	2500	3	3	2,5	2,5	3,1	T4DB 150
	225	48	355	643	1900	2100	3	2,5	3	2,5	6,4	32030
	225	59	444	849	1900	2200	3	2,5	3	2,5	8,05	33030
	270	49	412	555	1700	1900	4	3	4	3	10,5	30230
	270	77	714	1120	1600	2000	4	3	4	3	18	32230
	320	72	806	1050	1000	1300	5	4	3	3	28,50	30330
	320	82	753	1010	1300	1600	5	4	5	4	27	31330
	320	114	1120	1640	910	1100	5	4	3	3	46,00	32330
	160	220	32	234	414	1900	2400	3	3	2,5	2,5	3,25
240		51	417	773	1700	2000	3	2,5	3	2,5	7,85	32032
245		61	508	973	1700	2100	3	2	3	2	10,5	T4EE 160
290		52	512	720	1500	1800	4	3	4	3	13	30232
290		84	848	1370	1500	1800	4	3	4	3	23	32232
340		75	886	1160	1400	1600	5	4	5	4	29	30332
165	290	63500	626	981	1000	1300	7	3,3	6,5	3	17,50	BT1B 440771
170	230	32	245	434	1800	2300	3	3	2,5	2,5	3,45	T4DB 170
	230	38	278	581	1800	2300	2,5	2	2,5	2	4,5	32934
	240	46	377	739	1200	1500	3	2,5	2,5	2,5	6,50	JM 734449/JM 734410
	260	57	500	903	1600	1800	3	2,5	3	2,5	10,5	32034
	310	57	597	855	1400	1600	5	4	5	4	16,5	30234
	310	91	972	1610	1400	1600	5	4	5	4	28,5	32234
180	360	80	982	1330	910	1200	5	4	3	3	35,00	30334
	240	32	244	446	1700	2200	3	3	2,5	2,5	3,6	T4DB 180
	250	45	345	727	1600	2200	2,5	2	2,5	2	6,65	32936

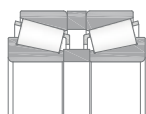

DB

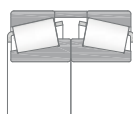

DF

Main dimensions			Basic load ratings		Speed ratings		Dimensions				Mass	Designation
d	D	T	Dynamic C	Static C ₀	Reference	Limiting	r _{1,2min}	r _{3,4min}	r _{amax}	r _{bmax}		
[mm]			[kN]		[rpm]		[mm]				[kg]	-
180	250	47	359	683	1100	1400	3	2,5	2,5	2,5	6,65	JM 736149/JM 736110
	280	64	625	1140	1500	1800	3	2,5	3	2,5	14	32036
	320	57	561	800	1400	1700	5	4	5	4	17	30236
	320	91	978	1610	1300	1600	5	4	5	4	29,5	32236
190	260	45	348	752	1500	1900	2,5	2	2,5	2	7	32938
	260	46	349	752	1500	2000	3	4	2,8	2,5	7	JM 738249/210
	260	46	347	764	1000	1300	3	2,5	2,5	2	7,20	332265
	280	50	456	809	1000	1300	3	4	2,5	3	10,70	BT1B 328166
	290	64	643	1190	1400	1700	3	2,5	3	2,5	15	32038
	340	60	697	996	1300	1500	5	4	5	4	20,5	30238
	340	97	1140	1900	1200	1400	5	4	5	4	36	32238
200	260	28	192	411	1000	1300	1	1,5	1	1,5	4,00	BT1B 329053
	270	37	317	594	1500	1900	3	3	2,5	2,5	5,5	T4DB 200
	270	45	371	761	1000	1300	2,5	2	2	2	7,00	331473
	280	51	456	944	1400	1800	3	2,5	3	2,5	9,5	32940
	300	54,5	538	989	970	1200	4	3	3	2,5	12,70	330710
	300	65	639	1230	910	1100	3,5	2,5	3	2	15,50	JHM 840449/JHM 840410
	310	70	724	1360	1300	1600	3	2,5	2,5	2,5	19	32040
	317,5	70	698	1300	920	1200	3,5	3,5	3	3	20,30	440408
	360	64	772	1110	1200	1400	5	4	5	4	24,5	30240
	360	104	1170	1960	1200	1300	5	4	5	4	42,5	32240
	210	260	30	189	459	1000	1300	2	1,5	2	1,5	3,40
300		54,5	538	999	970	1200	4	3	4	2,5	11,40	332284
215	340	76	876	1650	870	1100	4	3	3	2,5	25,50	332110
220	285	41	382	817	960	1200	4	3	3	2,5	6,45	T2DC 220
	300	51	471	992	1300	1700	3	2,5	3	2,5	10	32944
	340	76	864	1640	1200	1400	4	3	4	3	24,5	32044
	340	90,475	1010	2060	870	1100	4	3	3	2,5	30,30	BT1B 328144
	400	72	966	1390	1100	1300	5	4	4	3	34,5	30244
	400	90	1040	1740	720	860	5	5	4	4	45,50	332348
	400	114	1570	2680	1000	1200	5	4	4	3	59,5	32244
240	320	42	419	805	1200	1500	3	3	2,5	2,5	8,45	T4EB 240
	320	51	499	1070	1200	1500	3	2,5	3	2,5	11	32948
	320	57	597	1300	1200	1500	3	2	3	2	12,5	T2EE 240/VB406
	360	76	900	1780	1100	1300	4	3	4	3	26,5	32048

Single row tapered roller bearings - Metric

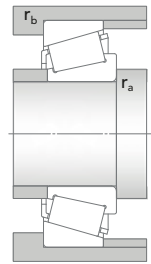
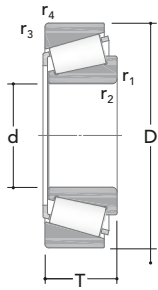

TS

Main dimensions			Basic load ratings		Speed ratings		Dimensions				Mass	Designation
d	D	T	Dynamic C	Static C ₀	Reference	Limiting	r _{1,2min}	r _{3,4min}	r _{amax}	r _{bmax}		
[mm]			[kN]		[rpm]		[mm]				[kg]	-
240	440	127	1720	3290	960	1000	5	4	4	3	83,5	32248
242	406	97	1370	2490	770	940	4	4	3	3	49,00	332255
255	560	123	1760	2660	540	620	6	6	5	5	123,00	BT1B 328213
260	400	87	1130	2170	1000	1200	5	4	5	4	38	32052
	400	98	1360	2570	760	940	4	1,5	3	-	42,50	BT1B 329066
	410	95	1380	2590	780	920	5	5	4	4	45,50	BT1B 332551
	480	137	2120	3630	860	1000	6	5	5	4	105	32252
	540	109	2060	3000	610	710	6	6	5	5	107,00	BT1B 332973
540	113	2040	3000	820	1000	6	6	5	5	110	30352	
280	380	63,5	745	1630	770	950	3	2,5	2,5	2,5	20,00	32956
	420	87	1160	2340	960	1100	5	4	5	4	40,5	32056
300	420	76	1010	2230	920	1200	4	3	4	3	31,5	32960
	460	100	1490	2990	870	990	5	4	5	4	58	32060
	540	149	2680	4680	780	950	6	5	5	4	140	32260
320	440	76	1040	2310	870	1000	4	3	4	3	33,5	32964
	480	100	1500	3090	830	930	5	4	5	4	64	32064
	620	141	2740	4590	510	590	7,5	7,5	7	7	180,00	332303
340	460	76	1030	2350	810	1100	4	3	4	3	35	32968
360	480	76	1080	2540	770	1000	4	3	4	3	37	32972
	680	165	3540	6180	460	530	7,5	7,5	6	6	260,00	332302
460	860	210	5400	10130	340	400	7,5	7,5	6	6	510,00	332304
560	1080	265	8740	15910	180	230	9,5	9,5	8	8	1060,00	BT1B 334018
680	1000	190	5470	12650	250	300	6	6	5	5	485,00	BT1B 332787
710	950	113	2770	6490	250	310	6	6	5	5	200,00	BT1B 332890
900	1180	122	3800	8970	170	210	6	6	5	5	340,00	BT1B 328214

Single row tapered roller bearings - Inch

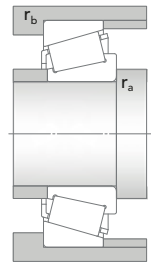
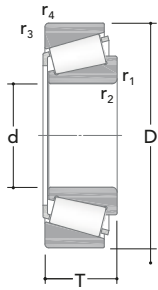

TS

Main dimensions			Basic load ratings		Speed ratings		Dimensions				Mass	Designation
d	D	T	Dynamic C	Static C ₀	Reference	Limiting	r _{1,2min}	r _{3,4min}	r _{amax}	r _{bmax}		
[mm/in]			[kN]		[rpm]		[mm]				[kg]	-
14,989 0.5901	34,988 1.3775	10,998 0.433	13,0	13,0	15500	18900	0,8	1,3	0,8	1,3	0,051	A 4059/A 4138
15,875 0.625	41,275 1.625	14,288 0.5625	21,5	21,1	19500	17100	1,3	2	1,3	2	0,095	03062/03162
	42,862 1.6875	14,288 0.5625	17,0	17,5	11500	14300	1,5	1,5	1,5	1,5	0,1	11590/11520
17,462 0.6875	39,878 1.57	13,843 0.545	20,8	20,8	12700	16500	1,3	1,3	1,3	1,3	0,082	LM 11749/710
19,05 0.75	45,237 1.781	15,494 0.61	26,8	27,4	11700	15200	1,3	1,3	1,3	1,3	0,12	LM 11949/910
	49,225 1.938	18,034 0.71	45,6	51,7	10700	14700	1,3	1,3	1,3	1,3	0,17	09067/09195
	49,225 1.938	19,845 0.7813	38,3	40,0	10700	14700	1,5	1,3	1,5	1,3	0,19	09074/09195
21,43 0.8437	45,237 1.781	15,492 0.6099	26,9	30,6	10700	14700	1,3	1,3	1,3	1,3	0,12	LM 12748/710
21,986 0.8656	45,237 1.781	15,494 0.61	26,9	30,9	10700	14500	1,3	1,3	1,3	1,3	0,12	LM 12749/710
	45,974 1.81	15,494 0.61	26,9	30,9	10700	14500	1,3	1,3	1,3	1,3	0,12	LM 12749/711
25,4 1	50,292 1.98	14,224 0.56	25,1	29,9	9600	12500	1,3	1,3	1,3	1,3	0,13	L 44643/610
	50,8 2	15,011 0.591	27,4	30,4	14000	12500	1,5	1,5	1,5	1,5	0,13	07100/07210
	57,15 2.25	17,462 0.6875	39,3	45,4	8800	10800	1,3	1,5	1,3	1,5	0,22	15578/15520
	57,15 2.25	19,431 0.765	38,3	44,4	8800	10800	1,5	1,5	1,5	1,5	0,24	M 84548/2/510/2
	62 2.4409	19,05 0.75	46,6	56,1	7700	9800	0,8	1,3	0,8	1,3	0,31	15101/15245
26,162 1.03	61,912 2.4375	19,05 0.75	46,7	56,1	7700	10200	0,8	2	0,8	2	0,29	15103 S/15243
	62 2.4409	19,05 0.75	46,7	56,1	7700	10200	0,8	1,3	0,8	1,3	0,29	15103 S/15245

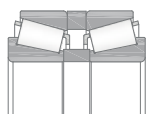

DB

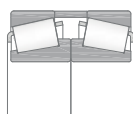

DF

Main dimensions			Basic load ratings		Speed ratings		Dimensions				Mass	Designation
d	D	T	Dynamic C	Static C ₀	Reference	Limiting	r _{1,2min}	r _{3,4min}	r _{amax}	r _{bmax}		
[mm/in]			[kN]		[rpm]		[mm]				[kg]	-
26,988 1.0625	50,292 1.98	14,224 0.56	25,1	29,9	9600	12600	3,5 0.14	1,3 0.05	3,3	1,3	0,11	L 44649/610
27,5 1.0827	57,15 2.25	19,845 0.7813	44,4	50,5	8700	11000	2,5 0.1	0,8 0.03	2,5	0,8	0,22	1982 F/1924 A
28,575 1.125	57,15 2.25	19,845 0.7813	46,0	54,6	8700	10900	0,8 0.03	1,5 0.06	0,8	1,5	0,23	1985/1922
	57,15 2.25	19,845 0.7813	46,0	54,6	8700	10900	3,5 0.14	1,5 0.06	3,3	1,5	0,22	1988/1922
	64,292 2.5312	21,433 0.8438	47,9	60,9	7700	9100	1,5 0.06	1,5 0.06	1,5	1,5	0,35	M 86647/610
	73,025 2.875	22,225 0.875	55,8	68,4	6800	8300	0,8 0.03	3,3 0.13	0,8	3,1	0,49	02872/02820
29 1.1417	50,292 1.98	14,224 0.56	25,1	32,1	9100	11900	3,5 0.14	1,3 0.05	3,3	1,3	0,11	L 45449/410/Q
30,162 1.1875	64,292 2.5312	21,433 0.8438	48,1	59,9	7700	9260	1,5 0.06	1,5 0.06	1,5	1,5	0,33	M 86649/2/610/2
	68,262 2.6875	22,225 0.875	53,5	69,0	7200	9100	2,3 0.09	1,5 0.06	2,3	1,5	0,41	M 88043/010/2
31,75 1.25	59,131 2.328	15,875 0.625	33,9	41,4	8300	10100	3,6 0.14	1,3 0.05	3,4	1,3	0,18	LM 67048/010
	61,912 2.4375	18,161 0.715	47,4	57,0	7800	10100	4 0.16	2 0.08	3,8	2	0,24	15123/15243
	62 2.4409	18,161 0.715	47,4	57,0	7800	10100	4 0.16	1,3 0.05	3,8	1,3	0,24	15123/15245
	73,025 2.875	29,37 1.1563	68,6	93,5	6500	8300	1,3 0.05	3,3 0.13	1,3	3,1	0,62	HM 88542/510
33,338 1.3125	68,262 2.6875	22,225 0.875	53,8	68,7	7300	9100	0,8 0.03	1,5 0.06	0,8	1,5	0,38	M 88048/2/010/2
34,925 1.375	65,088 2.5625	18,034 0.71	45,8	56,3	7200	9400	0,8 0.03	1,3 0.05	0,8	1,3	0,26	LM 48548 A/510
	65,088 2.5625	18,034 0.71	45,8	56,3	7200	9400	3,5 0.14	1,3 0.05	3	1,3	0,25	LM 48548/510
	69,012 2.717	19,845 0.7813	51,8	66,4	7200	9100	1,5 0.06	1,3 0.05	1,5	1,3	0,34	14137 A/14276

Single row tapered roller bearings - Inch

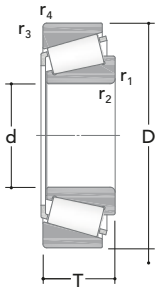

TS

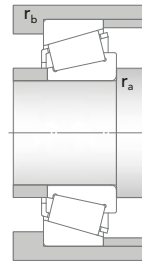

Main dimensions			Basic load ratings		Speed ratings		Dimensions				Mass	Designation
d	D	T	Dynamic C	Static C ₀	Reference	Limiting	r _{1,2min}	r _{3,4min}	r _{amax}	r _{bmax}		
[mm/in]			[kN]		[rpm]		[mm]				[kg]	-
34,925 1.375	72,233 2.8438	25,4 1	64,7	88,5	6400	8300	2,3 0.09	2,3 0.09	2,3	2,3	0,5	HM 88649/2/610/2
	73,025 2.875	23,812 0.9375	69,6	86,7	6800	8600	1,5 0.06	0,8 0.03	1,5	0,8	0,47	25877/2/25821/2
	73,025 2.875	26,988 1.0625	74,8	92,8	6800	8600	3,5 0.14	1,5 0.06	3,3	1,5	0,52	23690/23620
	76,2 3	29,37 1.1563	80,2	99,2	6500	8300	1,5 0.06	3,3 0.13	1,5	3,1	0,63	31594/31520
	76,2 3	29,37 1.1563	75,1	105	6000	7900	3,5 0.14	3,3 0.13	3,3	3,1	0,66	HM 89446/2/410/2
34,988 1.3775	59,131 2.328	15,875 0.625	32,0	44,0	7700	10300	3,5 0.14	1,3 0.05	3,3	1,3	0,17	L 68149/110
36,512 1.4375	76,2 3	29,37 1.1563	75,6	105	6000	8200	3,5 0.14	3,3 0.13	3,3	3,1	0,64	HM 89449/2/410/2
38,1 1.5	65,088 2.5625	18,034 0.71	41,3	56,6	7300	9500	2,3 0.09	1,3 0.05	2,3	1,3	0,23	LM 29748/710
	65,088 2.5625	18,034 0.71	41,3	56,6	7300	9500	2,3 0.09	1,3 0.05	2	1,3	0,24	LM 29749/710
	65,088 2.5625	18,034 0.71	41,3	56,6	7300	9500	2,3 0.09	1,3 0.05	2,3	1,3	0,24	LM 29749/711
	76,2 3	23,812 0.9375	73,1	92,8	6500	8600	3,5 0.14	3,3 0.13	3,3	3,1	0,5	2788/2720
	79,375 3.125	29,37 1.1563	88,7	108	6500	7800	3,5 0.14	3,3 0.13	3,3	3,1	0,67	3490/3420
	82,55 3.25	29,37 1.1563	83,2	116	5800	7000	2,3 0.09	3,3 0.13	2,3	3,1	0,78	HM 801346 X/2/310
	82,55 3.25	29,37 1.1563	83,2	116	5800	7000	0,8 0.03	3,3 0.13	0,8	3,1	0,78	HM 801346/310
	88,5 3.4842	26,988 1.0625	97,3	112	6000	7700	3,5 0.14	1,5 0.06	3,3	1,5	0,83	418/414
41,275 1.625	73,431 2.891	19,558 0.77	53,9	68,0	6500	8500	3,5 0.14	0,8 0.03	3,3	0,8	0,34	LM 501349/310
	73,431 2.891	21,43 0.8437	53,9	68,0	6500	8500	3,5 0.14	0,8 0.03	3,3	0,8	0,36	LM 501349/314
	76,2 3	18,009 0.709	44,7	55,9	6500	7900	0,8 0.03	1,5 0.06	0,8	1,5	0,34	11163/11300

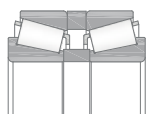

DB

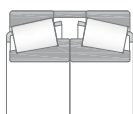

DF

Main dimensions			Basic load ratings		Speed ratings		Dimensions				Mass	Designation
d	D	T	Dynamic C	Static C ₀	Reference	Limiting	r _{1,2min}	r _{3,4min}	r _{amax}	r _{bmax}		
[mm/in]			[kN]		[rpm]		[mm]				[kg]	-
41,275 1.625	76,2 3	18,009 0.709	44,7	55,9	6500	7900	1,5 0.06	1,5 0.06	1,5	1,5	0,34	11162/11300
	76,2 3	22,225 0.875	65,9	86,1	6400	7800	3,5 0.14	0,8 0.03	3,3	0,8	0,43	24780/24720
	82,55 3.25	26,543 1.045	71,7	89,9	5800	7600	3,5 0.14	3,3 0.13	3,3	3,1	0,62	M 802048/011
	88,9 3.5	30,162 1.1875	115	172	5300	6600	3,5 0.14	3,3 0.13	3	3	0,9	HM 803146/110
42,875 1.688	82,931 3.265	23,812 0.9375	78,5	104	5800	7700	3,5 0.14	0,8 0.03	3,3	0,8	0,57	25577/2/25520/2
	83,058 3.27	26,998 1.0629	78,5	104	5800	7700	3,5 0.14	2,3 0.09	3,3	2,3	0,57	25577/2/25523/2
44,45 1.75	82,931 3.265	23,812 0.9375	78,8	105	5800	7700	3,5 0.14	0,8 0.03	3,3	0,8	0,57	25580/25520
	83,058 3.27	23,876 0.94	78,8	105	5800	7700	3,5 0.14	2 0.08	3,3	2	0,57	25580/25522
	83,058 3.27	26,988 1.0625	78,8	105	5800	7700	3,5 0.14	2,3 0.09	3,3	2,3	0,57	25580/25523
	88,9 3.5	30,162 1.1875	91,7	126	5300	6500	3,5 0.14	3,3 0.13	3,3	3,1	0,85	HM 803149/110
	95,25 3.75	30,958 1.2188	86,0	96,3	4800	5900	2 0.08	2,3 0.09	2	2,3	0,93	53178/53377
	95,25 3.75	30,958 1.2188	97,2	120	4600	5800	3,5 0.14	0,8 0.03	3,3	0,8	1	HM 903249/2/210/2
	104,775 4.125	36,512 1.4375	147	214	4300	5500	3,5 0.14	3,3 0.13	3,3	3,1	1,5	HM 807040/010
	107,95 4.25	36,512 1.4375	145	189	4600	5900	3,5 0.14	3,3 0.13	3,3	3,1	1,7	535/532 X
	111,125 4.375	38,1 1.5	145	189	4600	5900	3,5 0.14	3,3 0.13	3,3	3,1	1,85	535/532 A
45,237 1.781	87,312 3.4375	30,162 1.1875	99,5	130	5800	7100	3,5 0.14	3,3 0.13	1,5	3	0,85	3585/3525/Q
45,242 1.7812	73,431 2.891	19,558 0.77	52,3	74,3	6500	7900	3,5 0.14	0,8 0.03	3,3	0,8	0,31	LM 102949/910
	77,788 3.0625	19,842 0.7812	52,1	68,5	6000	7700	3,5 0.14	0,8 0.03	3,3	0,8	0,37	LM 603049/011

Single row tapered roller bearings - Inch

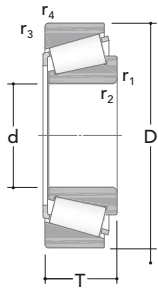

TS

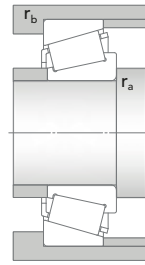

Main dimensions			Basic load ratings		Speed ratings		Dimensions				Mass	Designation
d	D	T	Dynamic C	Static C ₀	Reference	Limiting	r _{1,2min}	r _{3,4min}	r _{amax}	r _{bmax}		
[mm/in]			[kN]		[rpm]		[mm]				[kg]	-
45,618 1.796	82,931 3.265	26,988 1.0625	78,2	105	5700	7600	3,5 0.14	2,3 0.09	3,3	2,3	0,59	25590/25523
	83,058 3.27	23,876 0.94	78,2	105	5700	7600	3,5 0.14	2 0.08	3,3	2	0,55	25590/25522
46,038 1.8125	79,375 3.125	17,462 0.6875	48,0	61,3	6100	7600	2,8 0.11	1,5 0.06	2,6	1,5	0,33	18690/18620
	85 3.3465	20,638 0.8125	68,6	80,2	5800	7000	2,3 0.09	1,5 0.06	2,3	1,5	0,49	359 S/354 X
47,625 1.875	88,9 3.5	20,638 0.8125	73,8	90,2	5400	6900	2,3 0.09	1,3 0.05	2,3	1,3	0,55	369 S/2/362 A/2/
	95,25 3.75	30,162 1.1875	105	143	4800	6300	3,5 0.14	3,3 0.13	3,3	3,1	0,95	HM 804846/2/810/2
	101,6 4	34,925 1.375	147	187	4800	6300	8 0.31	3,3 0.13	7	3,1	1,25	528 R/522
49,212 1.9375	114,3 4.5	44,45 1.75	177	223	4300	5800	3,5 0.14	3,3 0.13	3,3	3,1	2,2	65390/65320
50,8 2	88,9 3.5	20,638 0.8125	74,4	90,9	5400	6900	3,5 0.14	1,3 0.05	3,3	1,3	0,5	368 A/362 A
	90 3.5433	25 0.9843	74,4	90,9	5400	6900	3,5 0.14	2 0.08	3,3	2	0,58	368 A/362 X
	93,264 3.6718	30,162 1.1875	106	146	5100	6100	3,5 0.14	3,3 0.13	3,3	3,1	0,87	3780/3720
	104,775 4.125	36,512 1.4375	141	203	4300	5700	3,5 0.14	3,3 0.13	3,3	3,1	1,5	HM 807046/010
	104,775 4.125	39,688 1.5625	182	280	4600	5800	3,5 0.14	3,3 0.13	3,3	3,1	1,65	4580/2/4535/2
53,975 2.125	88,9 3.5	19,05 0.75	57,1	77,1	5100	6600	2,3 0.09	2 0.08	2,3	2	0,44	LM 806649/610
	95,25 3.75	27,783 1.0938	102	136	5100	6400	1,5 0.06	2,3 0.09	1,5	2,3	0,8	33895/33821
	95,25 3.75	27,783 1.0938	101	136	5100	6400	1,5 0.06	0,8 0.03	1,5	0,8	0,81	33895/33822
	107,95 4.25	36,512 1.4375	148	188	4600	5900	3,5 0.14	3,3 0.13	3,3	3,1	1,45	539/532 X
	111,125 4.375	38,1 1.5	147	192	4600	5900	3,5 0.14	3,3 0.13	3,3	3,1	1,55	539/532 A

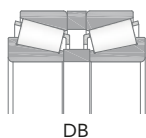

DB

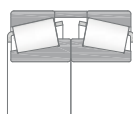

DF

Main dimensions			Basic load ratings		Speed ratings		Dimensions				Mass	Designation
d	D	T	Dynamic C	Static C ₀	Reference	Limiting	r _{1,2min}	r _{3,4min}	r _{amax}	r _{bmax}		
[mm/in]			[kN]		[rpm]		[mm]				[kg]	-
53,975 2.125	123,825 4.875	36,512 1.4375	137	159	3800	4700	3,5 0.14	3,3 0.13	3,3	3,1	2	72212/2/72487/2
57,15 2.25	96,838 3.8125	21 0.8268	77,9	100	4800	6200	3,5 0.14	0,8 0.03	3,3	0,8	0,59	387 A/382 A
	104,775 4.125	30,162 1.1875	118	159	4600	5700	2,3 0.09	3,3 0.13	2,3	3,1	1,05	462/453 X
	112,712 4.4375	30,162 1.1875	139	204	4200	5300	8 0.31	3,3 0.13	7	3,1	1,35	39581/39520
	119,985 4.7238	32,75 1.2894	139	204	4200	5300	3,5 0.14	0,8 0.03	3,3	0,8	1,75	39580/39528
	119,985 4.7238	32,75 1.2894	138	203	4100	5100	8 0.31	0,8 0.03	7	0,8	1,75	39581/39528
60,325 2.375	130,175 5.125	36,512 1.4375	145	177	3400	4100	5 0.2	3,3 0.13	4,6	3,1	2,1	HM 911245/W/210
61,912 2.4375	146,05 5.75	41,275 1.625	192	233	3000	3800	3,5 0.14	3,3 0.13	3,3	3,1	3,2	H 913842/810
	146,05 5.75	41,275 1.625	192	233	3000	3800	7 0.28	3,3 0.13	6,6	3,1	3,15	H 913843/810
63,5 2.5	112,712 4.4375	30,162 1.1875	121	183	4200	5400	3,5 0.14	3,3 0.13	3,3	3,1	1,25	3982/3920
65,088 2.5625	135,755 5.3447	53,975 2.125	277	396	3600	4700	3,5 0.14	3,3 0.13	3,3	3,1	3,7	6379/K-6320
66,675 2.625	112,712 4.4375	30,162 1.1875	138	201	4100	5400	3,5 0.14	3,3 0.13	3,3	3,1	1,15	39590/39520
	112,712 4.4375	30,162 1.1875	119	180	4100	5400	3,5 0.14	3,3 0.13	3,3	3,1	1,15	3984/2/3920/2
	119,985 4.7238	32,75 1.2894	138	201	4100	5400	3,5 0.14	0,8 0.03	3,3	0,8	1,2	39590/39528
	135,755 5.3447	53,975 2.125	277	395	3600	4600	4,3 0.17	3,3 0.13	3,9	3,1	3,65	6386/K-6320
69,85 2.75	120 4.7244	32,545 1.2813	151	227	3900	5100	3,5 0.14	0,5 0.02	3	0,5	1,5	47487/47420 A
	127 5	36,512 1.4375	170	254	3600	4600	3,5 0.14	3,3 0.13	3,3	3,1	1,9	566/563

Single row tapered roller bearings - Inch

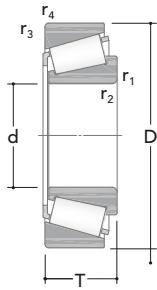

TS

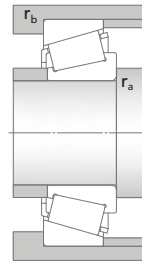

Main dimensions			Basic load ratings		Speed ratings		Dimensions				Mass	Designation
d	D	T	Dynamic C	Static C ₀	Reference	Limiting	r _{1,2min}	r _{3,4min}	r _{amax}	r _{bmax}		
[mm/in]			[kN]		[rpm]		[mm]				[kg]	-
73,025 2.875	127 5	36,512 1.4375	170	252	3600	4800	3,5 0.14	3,3 0.13	3,3	3,1	1,8	567/563
76,2 3	109,538 4.3125	19,05 0.75	56,9	101	3900	4900	1,5 0.06	1,5 0.06	1,5	1,5	0,6	L 814749/710
	127 5	30,163 1.1875	133	201	3600	4400	3,5 0.14	3,3 0.13	3,3	3,1	1,45	42687/42620
	133,35 5.25	33,338 1.3125	160	255	3300	4100	6,4 0.25	3,3 0.13	6	3,1	1,95	47678/47620
	139,992 5.5115	36,512 1.4375	182	275	3300	4100	3,5 0.14	3,3 0.13	3,3	3,1	2,45	575/572
	161,925 6.375	49,212 1.9375	250	329	2600	3300	3,5 0.14	3,3 0.13	3,3	3,1	4,4	9285/9220
77,788 3.0625	127 5	30,163 1.1875	134	203	3700	4500	3,5 0.14	3,3 0.13	3	3	1,45	42690/42620
82,55 3.25	139,992 5.5115	36,512 1.4375	182	278	3300	4200	3,5 0.14	3,3 0.13	3,3	3,1	2,2	580/572
92,075 3.625	152,4 6	39,688 1.5625	190	305	2900	3800	3,5 0.14	3,3 0.13	3,3	3,1	2,7	598/592 A
95,25 3.75	152,4 6	39,688 1.5625	188	299	2900	3700	3,5 0.14	3,3 0.13	3,3	3,1	2,55	594/592 A
	168,275 6.625	41,275 1.625	225	364	2700	3300	3,5 0.14	3,3 0.13	3,3	3,1	3,75	683/672
100,012 3.9375	157,162 6.1875	36,512 1.4375	194	330	1800	2300	3,5	3,3	3	3	2,45	52393/52618
	161,925 6.375	36,512 1.4375	196	334	1800	2300	3,5	3,3	3	3	2,80	52393/52637
101,6 4	146,05 5.75	21,433 0.8438	79,0	151	1900	2400	1,5	1,5	1,5	1,5	1,15	L 521945/L 521910
	157,162 6.1875	36,512 1.4375	196	333	1800	2300	3,5	3,3	3	3	2,45	52400/52618
	157,162 6.1875	36,512 1.4375	196	333	1800	2300	8	3,3	7	3	2,45	52401/52618
	161,925 6.375	36,512 1.4375	196	333	1800	2300	3,5	3,3	3	3	2,65	52400/52637

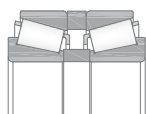

DB

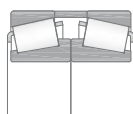

DF

Main dimensions			Basic load ratings		Speed ratings		Dimensions				Mass	Designation
d	D	T	Dynamic C	Static C ₀	Reference	Limiting	r _{1,2min}	r _{3,4min}	r _{amax}	r _{bmax}		
[mm/in]			[kN]		[rpm]		[mm]				[kg]	-
109,538 4,3125	158,75 6,25	23,02 0,9063	98,3	160	1800	2400	5	3,3	3	3	1,35	BT1B 332727
109,974 4,3297	177,8 7	41,275 1,625	246	415	1700	2200	3,5	3,3	3	3	3,70	64432/64700
	180 7,0866	41,275 1,625	246	415	1700	2200	3,5	3,3	3	3	3,90	64432/64708
109,987 4,3302	159,987 6,2987	34,925 1,375	149	343	1800	2400	7,9	3,3	7	3	2,20	LM 522548/LM 522510
	159,987 6,2987	34,925 1,375	149	343	1800	2400	3,5	3,3	3	3	2,30	LM 522549/LM 522510
109,992 4,3304	177,8 7	41,275 1,625	243	415	1700	2200	3,5	3,3	3	3	3,70	64433/64700
	180 7,0866	41,275 1,625	243	415	1700	2200	3,5	3,3	3	3	3,90	64433/64708
114,3 4.5	177,8 7	41,275 1,625	246	410	2500	3200	3,5 0,14	3,3 0,13	3,3	3,1	3,6	64450/64700
	180 7,0866	41,275 1,625	246	410	2500	3200	3,5	3,3	3	3	3,80	64450/64708
	180,975 7,125	34,925 1,375	177	277	2500	3100	3,5 0,14	3,3 0,13	3,3	3,1	2,95	68450/68712
	190,5 7,5	47,625 1,875	307	511	1600	1900	3,5	3,3	3	3	5,25	71450/71750
	192 7,5591	47,625 1,875	310	516	1600	1900	3,5	3,3	3	3	5,40	71450/71753
	212,725 8,375	66,675 2,625	492	750	1600	1900	7	3,3	6	3	10,00	938/932
	212,725 8,375	66,675 2,625	624	1260	1600	1900	7	3,3	6	3	10,50	HH 224346/HH 224310
	228,6 9	53,975 2,125	711	945	1200	1500	3,5	3,3	3	3	9,65	HM 926740/HM 926710
114,976 4,5266	177,8 7	41,275 1,625	245	414	1700	2100	9	3,3	8	3	3,55	64452 A/64700
	180 7,0866	41,275 1,625	245	414	1700	2100	9	3,3	8	3	3,75	64452 A/64708
	212,725 8,375	66,675 2,625	550	1070	1000	1300	7	3,3	6	3	10,50	HH 224349/HH 224310

Single row tapered roller bearings - Inch

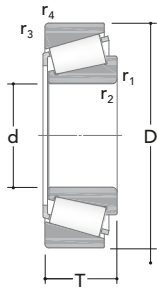

TS

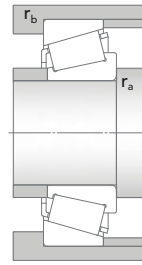

Main dimensions			Basic load ratings		Speed ratings		Dimensions				Mass	Designation
d	D	T	Dynamic C	Static C ₀	Reference	Limiting	r _{1,2min}	r _{3,4min}	r _{amax}	r _{bmax}		
[mm/in]			[kN]		[rpm]		[mm]				[kg]	-
117,475 4,625	180,975 7,125	34,925 1,375	179	279	1700	2100	3,5	3,3	3	3	2,80	68462/68712
	180,975 7,125	34,925 1,375	179	279	1700	2100	8	3,3	7	3	2,80	68463/68712
120,65 4,75	169,862 6,6875	25,4 1	127	261	1700	2100	1,5	1,5	1	1	1,85	L 225842/L 225810
	190,5 7,5	46,038 1,8125	308	540	1600	2000	3,5	1,5	3	1	4,85	HM 624749/HM 624710
	254 10	77,788 3,0625	712	1060	1300	1500	9,7	6,4	9	6	19,50	HH 228340/HH 228310
127 5	169,862 6,6875	25,4 1	129	265	1700	2100	1,5	1,5	1	1	1,60	L 225849/L 225810
	182,562 7,1875	39,688 1,5625	224	435	1600	1900	3,5	3,3	3	3	3,30	48290/48220
	196,85 7,75	46,038 1,8125	310	580	2100	2800	3,5	3,3	3,3	3,1	5,15	67388/67322
	215,9 8,5	47,625 1,875	334	600	1400	1600	3,5	3,3	3	3	7,00	74500/74850
	228,6 9	53,975 2,125	409	619	1400	1600	3,5	3,3	3	3	8,90	HM 926747/HM 926710
	254 10	77,788 3,0625	718	1060	1300	1500	9,7	6,4	9	6	18,50	HH 228349/HH 228310
133,35 5.25	177,008 6,9688	25,4 1	131	277	2300	3000	1,5	1,5	1,5	1,5	1,75	L 327249/210
	190,5 7,5	39,688 1,5625	237	492	1600	2000	3,5	3,3	3	3	3,55	48385/48320
	196,85 7,75	46,038 1,8135	312	583	1500	1800	3,5	3,3	3	3	4,70	67390/67322
	196,85 7,75	46,038 1,8125	312	583	1500	1800	8	3,3	7	3	4,65	67391/67322
	215,9 8,5	47,625 1,875	334	599	1400	1700	3,5	3,3	3	3	6,50	74525/74850
	234,95 9,25	63,5 2,5	533	900	1400	1700	9,7	3,3	9	3	11,50	95525/95925
	234,95 9,25	63,5 2,5	533	900	1400	1700	4,8	3,3	4	3	11,50	95528/95925

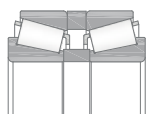
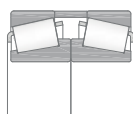

DB

DF

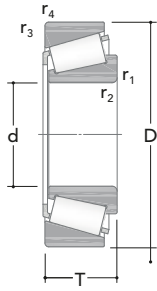
Main dimensions			Basic load ratings		Speed ratings		Dimensions				Mass	Designation
d	D	T	Dynamic C	Static C ₀	Reference	Limiting	r _{1,2min}	r _{3,4min}	r _{amax}	r _{bmax}		
[mm/in]			[kN]		[rpm]		[mm]				[kg]	-
136,525 5,375	190,5 7,5	39,688 1,5625	239	500	1600	2000	5,5	3,3	5	3	3,30	48393 A/48320
	190,5 7,5	39,688 1,5625	239	500	1600	2000	3,5	3,3	3	3	3,30	48393/48320
139,7 5,5	215,9 8,5	47,625 1,875	336	603	1400	1700	3,5	3,3	3	3	6,00	74550/74850
	236,538 9,3125	57,15 2,25	500	838	1300	1600	3,5	3,3	3	3	10,00	HM 231132/HM 231110
142,875 5,625	200,025 7,875	41,275 1,625	244	511	1500	1800	3,5	3,3	3	3	3,80	48685/48620
146,05 5,75	193,675 7,625	28,575 1,125	170	358	1500	1900	1,5	1,5	1	1	2,30	36690/36620
	193,675 7,625	28,575 1,125	170	358	1500	1900	4,8	1,5	4	1	2,30	36691/36620
	200,025 7,874	41,275 1,625	241	515	1500	1900	3,5	3,3	3	3	3,75	BT1B 332808
	241,3 9,5	57,15 2,25	463	828	1300	1500	3,5	3,3	3	3	10,00	82576/82950
	304,8 12	88,9 3,5	809	1130	910	1100	6,4	6,4	6	6	28,00	HH 932145/HH 932110
149,225 5,875	236,538 9.3125	57,15 2.25	492	834	1800	2300	6,4 0.25	3,3 0.13	6	3,1	9,05	HM 231148/110
152,4 6	222,25 8.75	46,83 1.8437	322	621	1900	2500	3,5 0.14	1,5 0.06	3,3	1,5	5,85	M 231649/610
	254 10	66,675 2,625	561	972	1200	1400	7	3,3	6	3	12,50	99600/99100
155,575 6,125	336,55 13,25	85,725 3,375	797	1180	860	1100	6,4	6,4	6	6	33,50	BT1B 328833
158,75 6.25	205,583 8.0938	23,812 0.9375	134	278	1900	2500	4,8 0.19	1,5 0.06	4,4	1,5	1,9	L 432348/310
	225,425 8,875	41,275 1,625	257	581	1300	1600	3,5	3,3	3	3	5,30	46780/46720

Single row tapered roller bearings - Inch

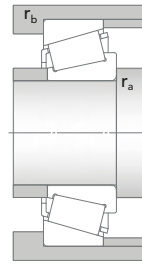

TS



Main dimensions			Basic load ratings		Speed ratings		Dimensions				Mass	Designation
d	D	T	Dynamic C	Static C ₀	Reference	Limiting	r _{1,2min}	r _{3,4min}	r _{amax}	r _{bmax}		
[mm/in]			[kN]		[rpm]		[mm]				[kg]	-
165,1 6,5	225,425 8,875	41,275 1,625	258	584	1300	1600	3,5	3,3	3	3	4,75	46790/46720
	336,5 13,25	92,075 3,625	1070	1680	910	1100	3,3	6,4	3	6	37,00	HH 437549/HH 437510
177,8 7	227,012 8,9375	30,162 1,1875	181	424	1700	2400	1,5	1,5	1,5	1,5	2,95	36990/36920
	260,35 10,25	53,975 2,125	474	899	1100	1400	3,5	3,3	3	3	9,35	M 236849/M 236810
178,595 7.0313	265,112 10.4375	51,595 2.0313	482	866	1600	2000	3,3	3,3	3,1	3,1	9,55	M 336948/912
							0,13	0,13				
179,934 7.084	265,112 10.4375	51,595 2.0313	476	873	1600	2000	3,3	3,3	3,1	3,1	9,4	M 336949/912
							0,13	0,13				
184,15 7,25	266,7 10,5	47,625 1,875	366	798	1000	1300	3,5	3,3	3	3	8,20	67883/67820
187,325 7,375	269,875 10,625	55,562 2,1875	456	936	1000	1300	3,5	3,3	3	3	9,85	M 238849/M 238810
	282,575 11.125	50,8 2	387	683	1500	1800	3,5	3,3	3,3	3,1	9,95	87737/87111
							0,14	0,13				
189,738 7,47	279,4 11	52,388 2,0625	512	970	1000	1300	3,3	3,3	3	3	11,00	M 239447/M 239410
190,475 7.5	279,4 11	52,388 2,0625	504	964	1500	1800	3,3	3,3	3,1	3,1	9,5	M 239449/410
							0,13	0,13				
190,5 7,5	266,7 10,5	47,625 1,875	366	791	1000	1300	3,5	3,3	3	3	8,20	67885/67820
	282,575 11.125	50,8 2	394	688	1500	1900	3,5	3,3	3,3	3,1	9,55	87750/87111
							0,14	0,13				
191,237 7.529	279,4 11	52,388 2,0625	506	967	1500	1800	3,3	3,3	3,1	3,1	9,2	M 239448 A/410
							0,13	0,13				
196,85 7.75	241,3 9.5	23,812 0.9375	149	311	1600	2200	1,5	1,5	1,5	1,5	2,1	LL 639249/210
							0,06	0,06				

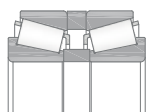

DB

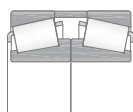

DF

Main dimensions			Basic load ratings		Speed ratings		Dimensions				Mass	Designation
d	D	T	Dynamic C	Static C ₀	Reference	Limiting	r _{1,2min}	r _{3,4min}	r _{amax}	r _{bmax}		
[mm/in]			[kN]		[rpm]		[mm]				[kg]	-
196,85 7.75	257,175 10.125	39,688 1.5625	266	653	1500	2000	3,5 0.14	3,3 0.13	3,3	3,1	5,35	LM 739749/710
200,025 7.875	276,225 10.875	42,862 1.6875	378	778	1400	1900	3,5 0.14	3,3 0.13	3,3	3,1	7,7	LM 241147/110
203,2 8	261,142 10,2812	28,575 1,125	208	433	1000	1300	1,5	1,5	1,5	1,5	3,75	LL 641149/LL 641110
	282,575 11,125	46,038 1,8125	368	821	960	1300	3,5	3,3	3	3	8,95	67983/67920
203,987 8.031	276,225 10.875	42,862 1.6875	377	776	1400	1800	3,5 0.14	3,3 0.13	3,3	3,1	7,2	LM 241148/110
206,375 8.125	282,575 11.125	46,038 1.8125	216	409	1400	1800	3,5 0.14	3,3 0.13	3,3	3,1	8,6	67985/67920/HA3VQ117
	282,575 11.125	46,038 1.8125	368	821	960	1300	3,5 0.14	3,3 0.13	3	3	8,60	67985/67920
	336,55 13,25	98,425 3,875	1100	2140	870	1000	3,3	3,3	3	3	34,00	H 242649/H 242610
212,725 8.375	285,75 11,25	46,038 1,8125	339	767	960	1200	3,5	3,3	3	3	8,00	LM 742745/LM 742710
215,9 8,5	285,75 11,25	46,038 1,8125	341	771	960	1200	3,5	3,3	3	3	7,90	LM 742749/LM 742710
216,408 8.52	285,75 11,25	46,038 1,8125	368	848	1400	1800	3,5 0.14	3,3 0.13	3,3	3,1	7,9	LM 742747/710
	285,75 11,25	46,038 1,8125	323	687	970	1200	3,5	3,3	3	3	7,85	BT1B 443786
216,713 8.532	285,75 11,25	46,038 1,8125	369	834	1400	1800	3,5 0.14	3,3 0.13	3,3	3,1	7,85	LM 742747 A/710
220,116 8,666	317,5 12,5	47,625 1,875	508	972	870	1000	3,3	3,3	3	3	12,50	LM 245832/LM 245810
220,878 8,696	317,5 12,5	47,625 1,875	504	964	860	1100	3,3	3,3	3	3	12,50	LM 245833/LM 245810

Single row tapered roller bearings - Inch

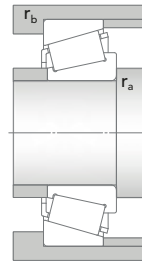
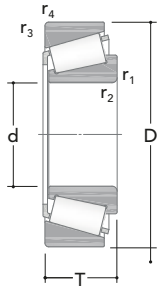

TS

Main dimensions			Basic load ratings		Speed ratings		Dimensions				Mass	Designation
d	D	T	Dynamic C	Static C ₀	Reference	Limiting	r _{1,2min}	r _{3,4min}	r _{amax}	r _{bmax}		
[mm/in]			[kN]		[rpm]		[mm]				[kg]	-
230,188 9,0625	317,5 12,5	47,625 1,875	506	968	870	1000	3,3	3,3	3	3	11,00	LM 245846/LM 245810
231,775 9.125	300,038 11.8125	33,338 1.3125	211	419	1300	1600	3,5 0.14	3,3 0.13	3,3	3,1	5,3	544091/2B/118 A/2B
	317,5 12,5	47,625 1,875	507	969	870	1100	3,3	3,3	3	3	10,50	LM 245848/LM 245810
247,65 9,75	406,4 16	115,888 4,5625	1570	3140	780	940	6,4	6,4	6	6	60,00	HH 249949/HH 249910
254 10	533,4 21	133,35 5,25	2040	2860	580	660	6,4	6,4	6	6	120,00	BT1B 332901
	533,4 21	133,35 5,25	1790	2690	570	680	6,4	6,4	6	6	121,00	HH 953749/HH 953710
255,6 10.063	342,9 13.5	57,15 2.25	639	1380	1100	1400	1,5 0.06	3,3 0.13	1,5	3	15	M 349547/510
255,625 10.064	342,945 13,5012	57,15 2,25	643	1370	820	1000	6,4	3,3	6	3	14,00	BT1B 417708
	342,945 13,5012	57,15 2,25	643	1370	820	1000	6,4	3,3	6	3	14,40	BT1P-255-417054
257,175 10.125	342,9 13.5	57,15 2.25	643	1370	820	1000	6,4 0.25	3,3 0.13	6	3	14	M 349549/510
	358,775 14.125	71,438 2.8125	813	1730	1100	1400	1,5 0.06	3,3 0.13	1,5	3	21,5	M 249747/710
263,525 10.375	325,438 12.8125	28,575 1.125	213	548	1200	1400	1,5 0.06	1,5 0.06	1,5	1,5	5,3	38880/38820
265 10,4331	355,6 14	57,15 2,25	620	1390	810	1000	3,5	3,3	3	3	16,00	LM 451347/LM 451310
266,56 10,4995	325,438 12,8125	29,5 1,1614	205	475	880	1100	1	1,5	1	1,5	5,10	BT1B 446356
266,7 10,5	325,438 12,8125	27,755 1,0927	201	466	860	1000	1,5	1,5	1,5	1,5	5,10	BT1B 443884

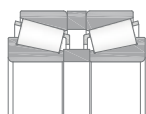
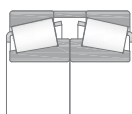

DB

DF

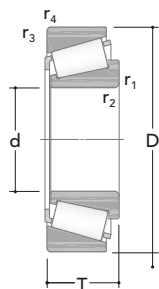
Main dimensions			Basic load ratings		Speed ratings		Dimensions				Mass	Designation
d	D	T	Dynamic C	Static C ₀	Reference	Limiting	r _{1,2min}	r _{3,4min}	r _{amax}	r _{bmax}		
[mm/in]			[kN]		[rpm]		[mm]				[kg]	-
266,7 10,5	355,6 14	57,15 2,25	631	1390	830	990	3,5	3,3	3	3	15,50	LM 451349/LM 451310
292,1 11,5	374,65 14,75	47,625 1,875	489	1130	1000	1300	3,5 0,14	3,3 0,13	3,3	3,1	12,5	L 555249/210
300 11,811	495,3 19,5	141,288 5,5625	2260	4470	610	700	6,4	6,4	6	6	107,00	HH 258248/HH 258210
304,8 12	393,7 15,5	50,8 2	309	610	960	1200	6,4 0,25	3,3 0,13	6	3,1	14,5	L 357049/010
	546,1 21,5	171,053 6,7344	2960	5590	580	670	8	8	7	7	170,00	BT1B 617089
330,2 13	415,925 16,375	47,625 1,875	386	946	670	810	3,5	3,5	3	3	14,30	BT1B 440009
	482,6 19	85,725 3,375	1170	2460	610	720	6,4	3,3	6	3	48,50	EE 526130/526190
333,375 13,125	469,9 18,5	90,488 3,5625	1290	2830	600	730	6,4	3,3	6	3	47,00	HM 261049/HM 261010
343,154 13,51	450,85 17,75	66,675 2,625	913	2190	870	1100	8,5 0,33	3,5 0,14	7,5	3,3	28	LM 361649 A/610
346,075 13,625	488,95 19,25	95,25 3,75	1370	3140	820	1100	6,4 0,25	3,3 0,13	6	3,1	55	HM 262749/710
355,6 14	482,6 19	60,32 2,3748	551	1190	600	700	7	7	6,5	6,5	26,50	431884 A
380,1 14,9606	480 18,8976	50 1,9685	575	1480	580	690	6	4	5	3,5	20,50	BT1B 380-332420
381 15	479,425 18,875	49,213 1,9375	574	1490	770	1000	6,4 0,25	3,3 0,13	6	3,1	20	L 865547/512
384,175 15,125	546,1 21,5	104,775 4,125	1810	4120	720	910	6,4 0,25	6,4 0,25	6	6	77	HM 266449/410

Single row tapered roller bearings - Inch

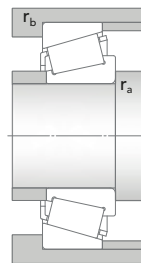

TS



Main dimensions			Basic load ratings		Speed ratings		Dimensions				Mass	Designation
d	D	T	Dynamic C	Static C ₀	Reference	Limiting	r _{1,2min}	r _{3,4min}	r _{amax}	r _{bmax}		
[mm/in]			[kN]		[rpm]		[mm]				[kg]	-
403,225 15,875	460,375 18,125	28,575 1,125	240	762	780	1000	3,5 0,14	3,3 0,13	3,3	3,1	6,7	LL 566848/810
406,4 16	508 20	61,912 2,4375	796	2080	540	640	3,3	3,3	3	3	26,50	L 467549/L 467510
	549,275	85,725	1340	3030	680	850	6,4 0,25	3,3 0,13	6	3,1	53,5	LM 567949/910
	574,675	76,2	906	2030	510	600	6,8	3,3	6	3	53,50	EE 285160/285226
	22,625	3										
	762	180,975	3590	6010	370	430	12,7	12,7	12	12	320,00	H 969249/H 969210
	30	7,125										
415,925 16,375	590,55 23,25	114,3 4,5	2050	4740	480	570	6,4 0,25	6,4 0,25	6	6	120,00	M 268749/M 268710
430,212 16,9375	603,25 23,75	76,2 3	1060	2270	480	560	6,4 0,25	6,4 0,25	6	6	59,00	EE 241693/242375
431,8 17	571,5 22,5	89,694 3,5313	1390	3420	480	560	6,4 0,25	6,4 0,25	6	6	60,00	BT1B 328284
431,902 17,004	685,698 26,996	177,8 7	3760	8510	410	480	6,4 0,25	6,4 0,25	6	6	253,00	BT1B 332900
447,675 17,625	635 25	120,65 4,75	2300	5430	430	490	6,4 0,25	6,4 0,25	6	6	120,00	M 270749/M 270710
457,2 18	573,088 22,5625	74,612 2,9375	1080	2940	480	550	6,4 0,25	6,4 0,25	6	6	43,50	L 570649/L 570610
	603,25	85,725	1400	3330	610	770	6,4 0,25	3,3 0,13	6	3,1	61,5	LM 770949/910
	23,75	3,375										
	615,95	85,725	1430	3740	440	520	6,4	6,4	6	6	72,00	LM 272235/LM 272210
	24,25	3,375										
	660,4	91,28	1750	3610	440	520	10,5	6,4	10	6	91,00	EE 737181/737260
	26	3,5937										
479,425 18,875	679,45 26,75	128,588 5,0625	2680	6270	410	460	6,4	6,4	6	6	145,00	BT1B 332529
480 18,8976	950 37,4016	240 9,4488	6820	12500	310	360	9,5	9,5	9	9	760,00	332263

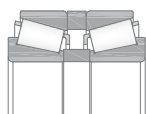
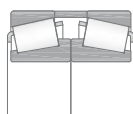

DB

DF

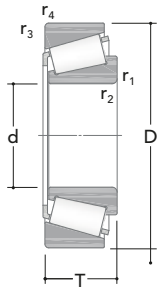
Main dimensions			Basic load ratings		Speed ratings		Dimensions				Mass	Designation
d	D	T	Dynamic C	Static C ₀	Reference	Limiting	r _{1,2min}	r _{3,4min}	r _{amax}	r _{bmax}		
[mm/in]			[kN]		[rpm]		[mm]				[kg]	-
482,6 19	634,873 24,995	80,962 3,1875	1430	3640	440	520	6,4 0,25	3,3 0,13	6	3	67,50	EE 243190/243250
488,95 19,25	634,873 24,995	84,138 3,3125	1400	3580	580	700	6,4 0,25	3,3 0,13	6	3,1	63,5	LM 772748/710
498,399 19,622	634,873 24,995	80,962 3,1875	1430	3600	430	490	6,4	3,3	6	3	60,00	EE 243196 AX/243250
498,475 19,625	634,873 24,995	80,962 3,1875	1430	3630	580	700	6,4 0,25	3,3 0,13	6	3,1	59,5	EE 243196/243250
498,653 19,632	634,873 24,995	80,962 3,1875	1410	3590	430	510	6,4 0,25	3,3 0,13	6	3	59,50	EE 243196 AS/243250
520,7 20,5	736,6 29	88,9 3,5	1600	3320	380	430	6,4 0,25	3,3 0,13	6	3	100,00	EE 982051/982900
536,575 21,125	761,873 29,995	146,05 5,75	3240	7970	360	430	6,4 0,25	6,4 0,25	6	6	208,00	M 276449/M 276410
	820 32,2835	152 5,9842	3800	7750	350	400	6	5	5	4	272,00	BT1B 328017
539,75 21,25	635 25	50,8 2	759	2110	410	470	6,4 0,25	6,4 0,25	6	6	27,00	LL 575349/LL 575310
549,275 21,625	692,15 27,25	80,963 3,1875	800	2090	540	640	6,4 0,25	6,4 0,25	6	6	67,00	L 476549/L 476510
558,8 22	736,6 29	88,108 3,4688	1760	4120	480	650	6,4 0,25	6,4 0,25	6	6	92,5	EE 843220/290
	736,6 29	104,775 4,125	2250	5690	480	650	6,4 0,25	6,4 0,25	6	6	115	LM 377449/410
607,72 23,926	787,4 31	93,662 3,6875	2100	5270	330	380	6,4 0,25	6,4 0,25	6	6	110,00	EE 649239/649310
609,6 24	787,4 31	93,662 3,6875	2090	5280	320	370	6,4 0,25	6,4 0,25	6	6	110,00	EE 649240/649310
	787,4 31	93,662 3,6875	2090	5280	430	550	6,4 0,25	6,4 0,25	6	6	110	EE 649240/310

Single row tapered roller bearings - Inch

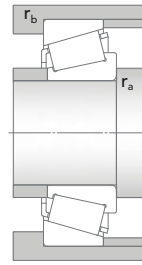

TS

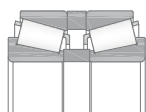
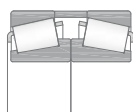

Main dimensions			Basic load ratings		Speed ratings		Dimensions				Mass	Designation
d	D	T	Dynamic C	Static C ₀	Reference	Limiting	r _{1,2min}	r _{3,4min}	r _{amax}	r _{bmax}		
[mm/in]			[kN]		[rpm]		[mm]				[kg]	-
635 25	736,6 29	57,15 2,25	825	2620	340	390	3,3 0,13	3,3 0,13	3	3	37,00	EK-80780/EK-80720
660,4 26	812,8 32	95,25 3,75	1870	5530	300	360	6,4 0,25	6,4 0,25	6	6	105,00	L 281147/L 281110
	939,8	136,525	3640	8090	270	320	6,4 0,25	6,4 0,25	6	6	287,00	332383
	1000	152,4	4220	9410	240	300	6,4 0,25	6,4 0,25	6	6	410,00	BT1B 334140
	39,3701	6										
679,45 26,75	901,7 35,5	142,875 5,625	3450	8870	270	310	9,7	6,4	9	6	242,00	LM 281849/LM 281810
682,625 26,875	965,2 38	185,738 7,3125	4920	12400	250	310	6,4 0,25	6,4 0,25	6	6	420,00	332283
	1080	200	6530	12900	210	270	12	12	11	11	640,00	BT1B 332705
	42,5197	7,874										
685,8 27	876,3 34,5	93,662 3,6875	2050	5440	290	320	6,4 0,25	6,4 0,25	6	6	130,00	EE 655270/655345
711,2 28	939,8 37	120,65 4,75	2540	6100	230	290	6,4 0,25	6,4 0,25	6	6	206,00	BT1B 328068
723,9 28,5	914,4 36	84,138 3,3125	1970	4820	270	320	5,5	6,4 0,25	5	6	115,00	EE 755285/755360
736,6 29	825,5 32,5	31,75 1,25	414	1360	280	330	3,5	3,3	3	3	22,50	LL 582949/LL 582910
749,3 29.5	990,6 39	159,5 6.2795	4410	11800	320	420	6,4 0,25	6,4 0,25	6	6	330	LM 283649/610
759,925 29,9183	889 35	69,85 2,75	1190	3780	270	320	3,3 0,13	3,3 0,13	3	3	67,50	LL 483448/LL 483418
	889 35	88,9 3,5	1870	6170	250	300	3,3 0,13	3,3 0,13	3	3	94,00	L 183448/L 183410
760 29.9212	889 35	69,85 2.75	1190	3770	540	480	3,3 0,13	3,3 0,13	3,1	3,1	67,5	LL 483448/418

DB

DF

Main dimensions			Basic load ratings		Speed ratings		Dimensions				Mass	Designation
d	D	T	Dynamic C	Static C ₀	Reference	Limiting	r _{1,2min}	r _{3,4min}	r _{amax}	r _{bmax}		
[mm/in]			[kN]		[rpm]		[mm]				[kg]	-
760 29.9212	889 35	88,9 3.5	1800	5800	340	440	3,3 0.13	3,3 0.13	3,1	3,1	94	L 183448/410
762 29.9999	889 35	69,85 2,75	1200	3750	370	480	3,3 0.13	3,3 0.13	3	3	66,50	LL 483449/LL 483418
	889 35	88,9 3.5	1820	5760	350	440	3,3 0.13	3,3 0.13	3,1	3,1	94	L 183449/410
774,7 30,5	965,2 38	93,662 3,6875	1880	4810	230	280	6,4 0.25	3,3 0.13	6	3	131,00	EE 752305/752380
801,688 31,5625	914,4 36	58,738 2,3125	1060	3500	250	310	3,5	3,3	3	3	53,50	LL 584449/LL 584410
838,2 33	1041,4 41	93,662 3,6875	1850	4770	210	260	6,4 0.25	6,4 0.25	6	6	160,00	EE 763330/763410
857,25 33,75	1092,2 43	120,65 4,75	2720	7280	190	240	19	6,4	18	6	245,00	EE 157337/157430
928 36,5354	1060 41,7323	92 3,622	2150	7980	180	230	3,3 0.13	3,3 0.13	3	3	119,00	JL 286948/JL 286910
930 36,6142	1060 41,7323	92 3,622	2140	7960	180	230	3,3 0.13	3,3 0.13	3	3	117,00	JL 286949/JL 286910
977,9 38,5	1130,3 44,5	66,675 2,625	1390	4330	170	220	6,4 0.25	6,4 0.25	6	6	100,00	LL 687949/LL 687910
1016 40	1270 50	101,6 4	2660	7480	160	200	9,7	9,7	9	9	275,00	EE 168400/168500

Double row tapered roller bearings

RKB double row tapered roller bearings are produced in several configurations (TDO, TDONSAW, TDI, TDIS) to support combined forces and locate the shaft in both directions. Manufactured with a given axial clearance (BEP), RKB double row tapered roller bearings can fully exploit their potential in a variety of industries and applications. In order to manufacture products with the highest possible resistance to fatigue and wear, RKB makes use of different bearing steel grades and special heat treatments. The bearing dimensional and running accuracy conforms to ISO/ABMA/GOST specifications.



Misalignment

Angular misalignment lead to uneven load distribution among rollers and rows as well as local overloading. Thus reduction in terms of bearing life expectation may appear.

Minimum load

In order to get a correct functioning double row tapered roller bearings have to be always loaded with a minimum value, in particular in case of application featuring high speed, high acceleration and/or quick variation of load direction. According to the above condition the minimum required load can be evaluated as following:

$$\frac{F_{rm}}{C} > 0,02$$

where:

- F_{rm} minimum radial load, [kN];
- C dynamic load rating, [kN].

Designs and variants

Type TDO

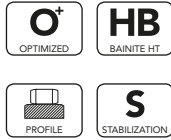
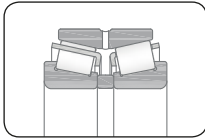

- One ribless outer ring (one double cup)
- Two inner rings with two ribs each (two single cones)
- Two one-piece window type pressed steel cages
- One single spacer between inner rings (plain or with lubrication grooves and holes)
- Supports radial and axial loads in both directions
- High arrangement stiffness
- Reduced angular misalignment
- Optimized roller profile
- Preset or adjusted BEP on customer's request
- Available in metric and inch sizes

Type TDONSAW

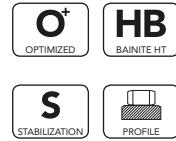
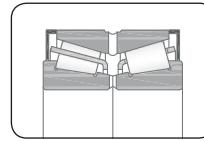

- One ribless outer ring (one double cup)
- Two inner rings with two ribs each (two single cones)
- Two one-piece window type pressed steel cages
- Lubrication grooves in cones internal side face
- Lateral shields or seals for contaminant exclusion
- Execution without spacer
- Supports radial and axial loads in both directions
- High arrangement stiffness
- Optimized roller profile
- Preset or adjusted BEP on customer's request
- Available in metric and inch sizes

Type TDI

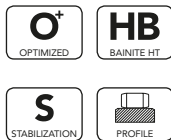
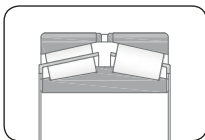

- Two ribless outer rings (two single cups)
- One inner ring with three ribs (one double cone)
- Two one-piece window type pressed steel cages
- One single spacer between outer rings (plain or with lubrication grooves and holes)
- Supports radial and axial loads in both directions
- Optimized roller profile
- Preset or adjusted BEP on customer's request
- Available in metric and inch sizes

Type TDIS

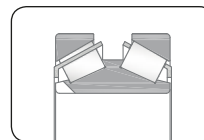

- Two ribless outer rings (two single cups)
- One inner ring with three ribs (one double cone)
- Two one-piece window type pressed steel cages
- Supports axial loads in both directions
- Designed with increased contact angle
- Suitable for high axial load carrying capacity
- Available with steel pin type cage and pierced roller design
- Available with one or more antirotation keyway slots on each side of double cone
- Available in metric and inch sizes

Double row tapered roller bearings

Type TDISS

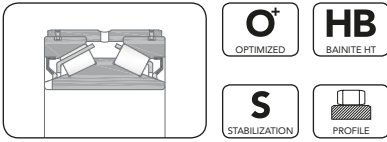

- Two ribless outer rings (two single cups)
- One inner ring with three ribs (one double cone)
- Two one-piece window type pressed steel cages
- Lateral seals for contaminant exclusion
- Preset or adjusted BEP on customer's request
- Designed with increased contact angle
- Suitable for high axial load carrying capacity
- Available with one or more antirotation keyway slots on each side of double cone
- Outer bush with annular groove and lubrication holes
- Available in metric and inch sizes

Suffixes	Internal design
B	In TDI bearings, special double cone width. The number immediately following the B gives the double cone width in mm (decimals excluded)
C	In TDO bearings, special double cup width. The number immediately following the C gives the double cone width in mm (decimals excluded)
ZB	Optimized roller profile for improved load distribution. It is not necessarily stated in the bearing code
SP	Special or non-standard bearing
BT2B	Double row tapered roller bearing

Suffixes	Accuracy, clearance, running
HP	High precision (better than P6)

Suffixes	External design
FF/1	FKM seal on both sides
FF	NBR seal on both sides

Part numbering

First system

	Section 1	Section 2	Section 3	Section 4	Section 5
	Configuration	Boundary dimensions	Execution	Material and heat treatment of bearing components	Special surface treatment
	TDO, TDI, TDONA, TDIS, TDISS, TDIT, TDOS, TDONASW, TDONASWE, TDONASWB	dxDxT/DxTxd	A1...An, AA, AB, AD, AC1, A1B etc. indicating major or minor revision based on: customer's request, application requirement, technology or design advancement, presence of special features. The meaning of such combination of characters and numbers may vary from bearing to bearing	HB1...HB7 HA1...HA7	PT1...PT7 AWT1...AWT7 ACT1...ACT3
Example	TDO	020503/519395	AA3	HA4	PT4
	One double cup, two single cones, and two one-piece window type pressed steel cages, one cone single spacer between cones.	d: 02,95 inches = 74,93 mm D: 05,51 inches = 139,95 mm T: 03,93 inches = 99,82 mm	As basic TDO configuration, but with counterbored hole for locking pin and special bench end play	Cones, cup and rollers in case hardening steel	Phosphate treated cones, cup and rollers

Tab. 17 (1 of 2) - First system: structure

Section 6	Section 7	Section 8	Section 9	Section 10
Roller features	Final bearing specification	K	$r_{1,2 \text{ min}}$ $r_{3,4 \text{ min}}$	Suffix
ZB	BT2B	The three figures immediately following the K indicates the K thrust value without a decimal mark	The four figures immediately following the three digits of the K value indicate the minimum values in mm of radii 1,2 and 3,4 without decimal marks	Different features from standard version
ZB	BT2B	K136	3506	VL
Optimized roller profile for improved load distribution	Double row tapered roller bearing	K: 1,36	$r_{1,2 \text{ min}}$: 3,5 mm $r_{3,4 \text{ min}}$: 0,6 mm	Victory Line

Tab. 17 (2 of 2) - First system: structure

Second system

	Section 1	Section 2	Section 3	Section 4
	Configuration	Boundary dimensions	Execution	Material and heat treatment of bearing components
	TDO, TDI, TDONA, TDIS, TDISS, TDIT, TDOS, TDONASW, TDONASWE, TDONASWB	Up to six digits	A1...An, AA, AB, AD, AE1, A1B etc. indicating major or minor revision based on: customer's request, application requirement, technology or design advancement, presence of special features. Typically the meaning of such combination of alphabetical and numerical characters vary from bearing to bearing.	HB1...HB7 HA1...HA7
Example	TDI	331792	A9	HB1
	Double row tapered roller bearing with one double cone, two one-piece window type pressed steel cages with rollers, two single cups, and one cup spacer. X configuration	No dimension indication	As basic TDI configuration, but with lubrication grooves in side faces of double cone	Cone and cups in through hardening steel with bainitic treatment

Tab. 18 (1 of 2) - Second system: structure

Section 5	Section 6	Section 7	Section 8
Configuration	Boundary dimensions	Execution	Material and heat treatment of bearing components
PT1...PT7 AWT1...AWT7 ACT1...ACT3	ZB	BT2B	Different features from standard version
ACT1	ZB	BT2B	VL
Anticorrosion treated cone and cups	Optimized roller profile for improved load distribution	Double row tapered roller bearing	Victory Line

Tab. 18 (2 of 2) - Second system: structure

Double row tapered roller bearings

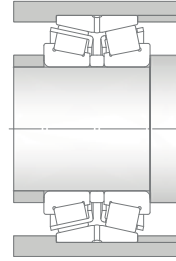
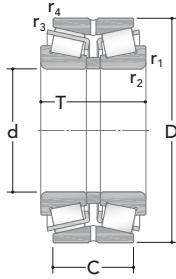

TDO

Main dimensions				Basic load ratings		Dimensions		Mass	Designation
d	D	T	C	Dynamic C	Static C ₀	r _{1,2min}	r _{3,4min}		(AFBMA part number)
[mm/in]				[kN]		[mm]		[kg]	-
100 3,937	150 5,9055	55 2,1653	39,05 1,5374	212	354	2,5	0,8	3,00	TDO 332759
	150 5,9055	76,2 3	61,976 2,44	289	538	3,5	0,6	4,25	TDO 328818
	180 7,0866	80 3,1496	64 2,5197	446	638	3	0,8	7,65	TDO 617335
101,6 4	146,05 5,75	49,212 1,9375	38,94 1,5331	210	373	1,5	0,8	2,45	TDO 332767 (L 521945-910D)
107,95 4,25	146,05 5,75	49,212 1,9375	39,688 1,5625	147	305	1,5	0,8	2,25	TDO 331392 (L 521949-910D)
	146,05 5,75	49,212 1,9375	39,688 1,5625	146	306	1,5	0,8	2,25	TDO 331571 (L 521949-910DC)
	158,75 6,25	53,978 2,1251	39,688 1,5625	124	321	3,5	0,8	3,00	TDO 614018 (37425-626D)
110 4,3307	200 7,874	90 3,5433	72 2,8346	544	784	3	1	11,00	TDO 328947
114,3 4,5	177,8 7	92,075 3,625	69,85 2,75	451	825	3,5	0,8	7,75	TDO 612700 (64450-700D)
120 4,7244	180 7,0866	86 3,3858	68 2,6772	405	829	2,5	0,8	7,10	TDO 331181
130 5,1181	230 9,0551	146 5,748	118,5 4,6677	915	1680	4	1,5	23,50	TDO 330431
133,35 5,25	215,9 8,5	106,362 4,1875	80,962 3,1875	618	1190	3,5	1,5	14,50	TDO 332160 (NA 74525-851D)
139,7 5,5	254 10	149,225 5,875	111,125 4,375	1030	1940	7	1,5	31,00	TDO 332750 (99550-102D)
140 5,5118	200 7,874	93,665 3,6876	73,025 2,875	452	1030	5	1	9,30	TDO 442210
146,05 5,75	193,675 7,625	65,085 2,5624	53,975 2,125	308	686	1,5	0,8	5,00	TDO 331943 (36690-620D)

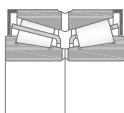

TDONASW

Main dimensions				Basic load ratings		Dimensions		Mass	Designation (AFBMA part number)
d	D	T	C	Dynamic C	Static C ₀	r _{1,2min}	r _{3,4min}		
[mm/in]				[kN]		[mm]		[kg]	-
150 5,9055	225 8,8583	107 4,2126	78 3,0709	663	1310	5	1	14,50	TDO 442211
152,4 6	222,25 8,75	100,01 3,9374	76,2 3	585	1230	3,5	0,8	12,00	TDO 613328 (M 231649-610D)
155 6,1024	200 7,874	66 2,5984	54 2,126	245	609	1,5	0,6	4,85	TDO 328957
160 6,2992	240 9,4488	114 4,4882	84 3,3071	771	1530	5	1	16,50	TDO 442212
	270 10,6299	150 5,9055	120 4,7244	1170	2240	4	1	32,50	TDO 332758
165,1 6,5	225,425 8,875	85,725 3,375	69,85 2,75	481	1170	8	0,8	10,00	TDO 331792 (46790-720D)
	288,925 11,375	142,875 5,625	111,125 4,375	1130	2240	7	1,5	38,00	TDO 328697 (94649-114CD)
177,8 7	269,875 10,625	119,062 4,6875	93,662 3,6875	847	1880	3,5	1,5	23,00	TDO 332585 (M 238840-810D)
180 7,0866	270 10,6299	109,538 4,3125	84,138 3,3125	664	1570	5	1	22,50	TDO 442213
187,325 7,375	269,875 10,625	119,062 4,6875	93,662 3,6875	845	1880	3,5	1,5	21,00	TDO 328698 (M 238849-810D)
200 7,874	290 11,4173	121 4,7638	88 3,4646	1340	2690	5	1	24,00	TDO 442214
200,025 7,875	317,5 12,5	146,05 5,75	111,125 4,375	1130	2390	4,3	1,5	41,50	TDO 332459 (93787-127D)
203,2 8	317,5 12,5	120,65 4,7635	88,9 3,5	975	1970	6,4	1,5	34,00	TDO 331785 (NA 132083-126D)
206,375 8,125	336,55 13,25	211,138 8,3125	169,862 6,6875	2060	4230	3,3	1,5	70,00	TDO 328270 (H 242649-610D)

Double row tapered roller bearings

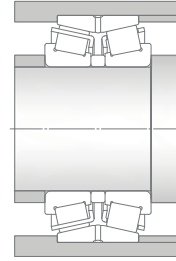
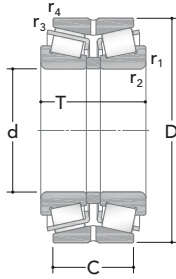

TDO

Main dimensions				Basic load ratings		Dimensions		Mass	Designation
d	D	T	C	Dynamic C	Static C ₀	r _{1,2min}	r _{3,4min}		(AFBMA part number)
[mm/in]				[kN]		[mm]		[kg]	-
220	340	164	130	1600	3280	4	1	50,00	TDO 332473
8,6614	13,3858	6,4567	5,1181						
	370	120	107	1250	2260	5	1,5	49,00	TDO 328794
	14,567	4,7244	4,2126						
228,6	327,025	114,3	82,55	814	2110	6,4	1,5	30,00	TDO 332584
9	12,875	4,5	3,25						(8573-8520D)
	358,775	152,4	117,475	1480	3530	3,5	1,5	57,00	TDO 332766
	14,125	6	4,628						(M 249732-710D)
	488,95	254	152,4	2840	4420	6,4	1,5	205,00	TDO 331945
	19,25	10	6						(HH 949549-510D)
241,3	368,3	120,65	85,725	970	2020	6,4	1,5	39,50	TDO 331783
9,5	14,5	4,75	3,375						(EE 170950-451D)
247,65	406,4	247,65	203,2	2850	6250	6,4	1,5	120,00	TDO 332443
9,75	16	9,75	8						(HH 249949-910D)
254	422,275	173,038	128,66	2170	4010	6,8	1,5	87,50	TDO 328615
10	16,625	6,8125	5,0653						
	422,275	178,592	139,7	2170	3970	6,8	1,5	97,50	TDO 331782
	16,625	7,0312	5,5						(HM 252343-310D)
	533,4	276,225	165,1	3340	5400	6,4	1,5	260,00	TDO 331781
	21	10,875	6,5						(HH 953749-710D)
260	360	105	76	950	1960	3	1	28,00	TDO 328027
	14,1732	4,1339	2,9921						
	400	104	92	1080	2050	5	1,5	44,00	TDO 328795
	15,748	4,0945	3,622						
	440	144	128	1800	3390	5	1,5	86,50	TDO 617479
	17,3228	5,6693	9,0394						
	480	284	220	3870	7230	5	1,5	210,00	TDO 328130
	18,8976	11,1811	8,6614						
260,35	422,275	178,592	139,7	2150	3980	6,8	1,5	86,50	TDO 328187
10,25	16,625	7,0312	5,5						(HM 252349-310D)
280	470	250	180	3380	6310	6,4	1,5	155,00	TDO 331717
11,0236	18,5039	9,8425	7,0866						

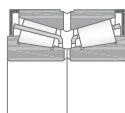

TDONASW

Main dimensions				Basic load ratings		Dimensions		Mass	Designation (AFBMA part number)
d	D	T	C	Dynamic C	Static C ₀	r _{1,2min}	r _{3,4min}		
[mm/in]				[kN]		[mm]		[kg]	-
285,75 11,25	380,898 14,996	139,7 5,5	107,95 4,25	1180	3170	3,5	1,5	42,00	TDO 332449 (LM 654648-610D)
288,925 11,375	406,4 16	165,1 6,5	130,175 5,125	1890	4430	6,4	1,5	63,00	TDO 332503 (M 255449-410CD)
300 11,811	500 19,685	203 7,9921	152 5,9843	2740	5040	5	1,5	140,00	TDO 328383
300,038 11,8125	422,275 16,625	174,625 6,875	136,525 5,375	1990	4720	6,4	1,5	71,50	TDO 332504 (HM 256849-810CD)
317,5 12,5	447,675 17,625	180,975 7,125	146,05 5,75	2240	5320	3,5	1,5	84,00	TDO 615058 (HM 259049-010D)
	447,675 17,625	180,975 7,125	146,05 5,75	2250	5330	3,5	1,5	84,00	TDO 332516 (HM 259049-010CD)
330,2 13	482,6 19	177,8 7	127 5	2150	4960	3,3	1,5	100,00	TDO 332845 (EE 526132/191D)
333,375 13,125	469,9 18,5	190,5 7,5	152,4 6	2390	5670	6,4	1,5	98,00	TDO 331775 (HM 261049-0100C)
340 13,3858	460 18,1102	160 6,2992	128 5,0394	1980	4880	3	1	71,00	TDO 332830
342,9 13,5	533,4 21	174,625 6,875	123,825 4,875	2310	4310	4,8	1,5	130,00	TDO 332802 (EE 971354-103D)
346,075 13,625	488,95 19,25	200,025 7,875	158,75 6,25	2560	6240	6,4	1,5	110,00	TDO 331981 (HM 262749-710D)
355,6 14	444,5 17,5	136,525 5,375	111,125 4,375	1210	3590	3,5	1,5	46,00	TDO 332505 (L 163149-110CD)
	501,65 19,75	155,575 6,125	107,95 4,25	1780	4240	6,4	1,5	87,00	TDO 332506 (EE 231400-976D)
360 14,1732	480 18,8976	160 6,2992	128 5,0394	1990	4950	3	1	73,00	TDO 332831

Double row tapered roller bearings

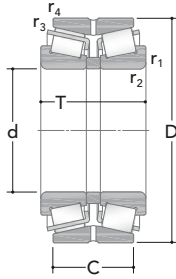

TDO

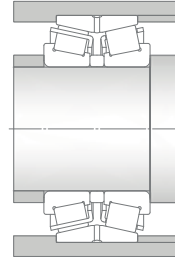

Main dimensions				Basic load ratings		Dimensions		Mass	Designation
d	D	T	C	Dynamic C	Static C ₀	r _{1,2min}	r _{3,4min}		(AFBMA part number)
[mm/in]				[kN]		[mm]		[kg]	-
368,249 14,498	523,875 20,625	214,312 8,4375	169,862 6,6875	3030	7480	6,4	1,5	140,00	TDO 332603 (HM 265049-010D)
368,3 14,5	596,9 23,5	203,2 8	133,35 5,25	2970	5810	9,7	2,3	188,00	TDO 332754 (EE 181453-351DC)
371,475 14,625	501,65 19,75	155,575 6,125	107,95 4,25	1750	4210	6,4	1,5	76,50	TDO 331606 (EE 231462-976CD)
380 14,9606	520 20,4724	148 5,8268	112 4,4095	2110	4450	4	1,5	80,20	TDO 328020
	660 25,9843	380 14,9606	310 12,2046	7370	15900	14	3,5	520,00	TDO 332823 (HH 267648-610D)
381 15	508 20	139,7 5,5	88,9 3,5	1330	3210	6,4	1,5	67,00	TDO 332507 (EE 192150-201CD)
384,175 15,125	546,1 21,5	222,25 8,75	177,8 7	3120	7340	6,4	1,6	161,00	TDO 331197 (HM 266449-410D)
406,4 15	539,75 21,25	142,875 5,625	101,6 4	1640	4350	6,4	1,5	82,40	TDO 328389 (EE 234160-213CD)
415,925 16,375	590,55 23,25	244,475 9,625	193,675 7,625	3760	9580	6,4	1,5	205,00	TDO 331656 (M 268749-710CD)
431,8 17	571,5 22,5	155,575 6,125	111,125 4,375	1920	5050	3,3	1,5	100,00	TDO 332604 (LM 869449-410D)
	571,5 22,5	192,088 7,5625	146,05 5,75	2560	6900	6,4	1,5	125,00	TDO 332237 (LM 769349-310DC)
440 17,3228	650 25,5906	196 7,7165	157 6,1811	3610	7570	6	3	203,00	TDO 328796
447,675 17,625	635 25	257,175 10,125	206,375 8,125	4300	10990	6,4	1,5	245,00	TDO 332176 (M 270749-710DC)
457,2 18	596,9 23,5	165,1 6,5	120,65 4,75	2080	5460	9,7	1,5	110,00	TDO 328980 (EE 244180-236CD)

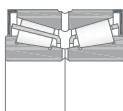

TDONASW

Main dimensions				Basic load ratings		Dimensions		Mass	Designation
d	D	T	C	Dynamic C	Static C ₀	r _{1,2min}	r _{3,4min}		(AFBMA part number)
[mm/in]				[kN]		[mm]		[kg]	-
479,425 18,875	679,45 26,75	276,225 10,875	222,25 8,75	4900	12670	6,4	1,5	302,00	TDO 331657 (M 272749-710DC)
489,026 19,253	634,873 24,995	177,8 7	142,875 5,625	2660	7270	6,4	1,5	130,00	TDO 331776 (EE 243192-251D)
498,475 19,625	634,873 24,995	177,8 7	142,875 5,625	2640	7280	6,4	1,5	125,00	TDO 331605 (EE 243196-251D)
	634,873 24,995	177,8 7	142,875 5,625	2650	7310	6,4	1,5	125,00	TDO 331605 (EE 243196-251CD)
501,65 19,75	711,2 28	292,1 11,5	231,775 9,125	5320	13530	6,4	1,5	343,00	TDO 332605 (M 274149-110CD)
508 20	838,2 33	304,8 12	222,25 8,75	6180	13870	9,7	3,3	630,00	TDO 614995 (EE 426200-331D)
520,7 20,5	736,6 29	186,502 7,3426	114,3 4,5	2950	6600	6,4	1,5	210,00	TDO 332761 (EE 982051-901CD)
536,575 21,125	761,873 29,995	311,15 12,25	247,65 9,75	6140	15990	6,4	1,5	430,00	TDO 332446 (M 276449-410CD)
558,8 22	736,6 29	187,328 7,375	138,112 5,4375	3300	8280	6,4	1,5	190,00	TDO 331790 (EE 843220-291D)
	736,6 29	225,425 8,875	177,8 7	4120	11380	6,4	1,5	150,00	TDO 331640 (LM 377449-410CD)
571,5 22,5	812,8 32	333,375 13,125	263,525 10,375	6230	15980	6,4	1,5	520,00	TDO 332447 (M 278749-710CD)
602,945 23,738	787,4 31	206,375 8,125	158,75 6,25	3900	10510	6,4	1,5	180,00	TDO 331576
609,6 24	812,8 32	190,5 7,5	146,05 5,75	3480	8650	6,4	3,3	250,00	TDO 614609 (EE 649240-311CD)
	787,4 31	206,375 8,125	158,75 6,25	3920	10440	6,4	1,5	232,00	TDO 332448
	820 32,2835	206,375 8,125	158,75 6,25	3920	10550	6,4	1,5	292,00	TDO 331500

Double row tapered roller bearings

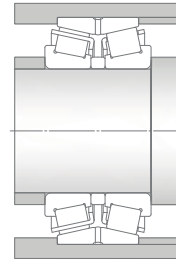
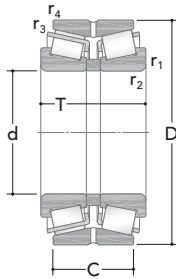

TDO

Main dimensions				Basic load ratings		Dimensions		Mass	Designation
d	D	T	C	Dynamic C	Static C ₀	r _{1,2min}	r _{3,4min}		(AFBMA part number)
[mm/in]				[kN]		[mm]		[kg]	-
635 25	990,6 39	339,725 13,375	212,725 8,375	7820	15950	6,4	6,4	840,00	TDO 332493
685,8 27	876,3 34,5	200,025 7,875	152,4 6	3790	10900	6,4	1,5	270,00	TDO 331290
711,2 28	914,4 36	190,5 7,5	139,7 5,5	3690	9480	6,4	1,5	265,00	TDO 328028 (EE 755280-361D)
723,9 28,5	914,4 36	187,325 7,375	139,7 5,5	3660	9490	3,3	1,5	250,00	TDO 331554 (EE 755285-361CD)
762 30	965,2 38	187,325 7,375	133,35 5,25	3490	9670	6,4	1,5	290,00	TDO 331780 (EE 752300-381D)
774,7 30,5	965,2 38	187,325 7,375	133,35 5,25	3470	9720	6,4	1,5	265,00	TDO 332764 (EE 752305-381D)
774,962 30,5103	1016 40	266,7 10,5	209,55 8,25	6210	16920	8	2,5	525,00	TDO 332625
812,8 32	1016 40	190,5 7,5	146,05 5,75	3490	10040	6,4	1,5	350,00	TDO 331291 (EE 762320-401D)
	1066,8 42	190,5 7,5	146,05 5,75	3440	10020	6,4	1,5	445,00	TDO 328371 (EE 762320-420XD)
863,6 34	1371,6 54	469,9 18,5	285,75 11,25	14180	31520	28	2	2250,00	TDO 332494
914,4 36	1066,8 42	139,7 5,5	101,6 4	2500	7850	6,4	3,3	190,00	TDO 332501 (LL 686947-910D)
	1066,8 42	139,7 5,5	101,6 4	2530	7890	6,4	3,3	190,00	TDO 332501 (LL 686947-910DC)
939,8 37	1270 50	547,2 18	317,5 12,5	9460	28940	12,7	3,3	1540,00	TDO 328304
1120 44,0945	1480 58,2677	400 15,748	296 11,6535	12870	37280	12	4	1760,00	TDO 332756

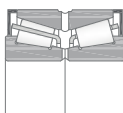

TDONASW

Main dimensions				Basic load ratings		Dimensions		Mass	Designation
d	D	T	C	Dynamic C	Static C ₀	r _{1,2min}	r _{3,4min}		(AFBMA part number)
[mm/in]				[kN]		[mm]		[kg]	-
1160 45,6693	1540 60,6299	400 15,748	290 11,4173	13820	37750	12	4	1900,00	TDO 332780
1250 49,2126	1500 59,0551	250 9,8425	190 7,4803	7160	22230	6	1,5	795,00	TDO 328339
1320,8 52	1727,2 68	412,75 16,25	254 10	13580	40090	28	2	2325,00	TDO 332495
1562,1 61,5	1806,575 71,125	279,4 11	196,85 7,75	7010	27800	9,7	3,3	1045,00	TDO 328310 (EE 299615-711D)
1778 70	2159 5	393,7 15,5	266,7 10,5	15010	52710	12,7	3	2750,00	TDO 332496
2133,6 84	2819,4 111	742 29,2126	457,2 18	33720	107000	15x45°	3,5	11600,00	TDO 332497
2184,4 86	2527,3 99,5	304,8 12	165,1002 6,5	9060	37490	16	5	2230,00	TDO 332673
2616,2 103	3048 120	381 15	209,5502 8,25	11800	52470	25,4	6,4	4485,00	BT2-8020
3378,2 133	3835,4 151	393,7 15,5	203,2003 8	14760	62240	25,4	6,4	6380,00	BT2-8019
3811 150	4216,4 166	419,1 16,5	274,7004 10,815	18940	107600	9,7	6,4	6315,00	TDO 334004

Double row tapered roller bearings

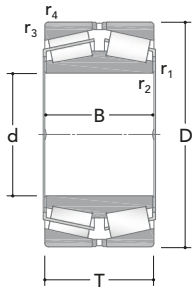

TDI

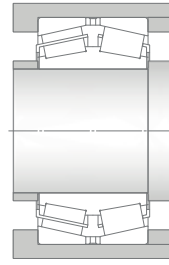

Main dimensions				Basic load ratings		Dimensions		Mass	Designation
d	D	T	B	Dynamic C	Static C ₀	r _{1,2min}	r _{3,4min}		(AFBMA part number)
[mm/in]				[kN]		[mm]		[kg]	-
152,4 6	222,25 8,75	84,138 3,3125	84,138 3,3125	583	1240	1,5	1,5	11,5	TDI 331387 (M 231649DW-610)
177,8 7	247,65 9,75	90,488 3,5625	90,488 3,5625	641	1480	1,5	3,3	13,0	TDI 331814 (67790DW-720)
	288,925	123,825	123,825	1260	2230	1,5	3,3	31,5	TDI 332534 (HM 237546DW-510)
	11,375	4,875	4,875						
203,2 8	317,5 12,5	133,35 5,25	133,35 5,25	1130	2390	6,4	3,3	40,0	TDI 332799 (93801D-125)
	368,3	158,75	152,4	1810	3320	3,3	3,3	75,0	TDI 332683 (EE 420800DW-450)
	14,5	6,25	6						
206,375 8,125	282,575 11,125	87,312 3,4375	87,312 3,4375	683	1640	0,8	3,3	17,0	TDI 331388 (67985DW-920)
	336,55	180,975	184,15	2050	4250	1,5	3,3	66,5	TDI 328834 (H 242649D-610/CL2)
	13,25	7,125	7,25						
220 8,6614	340 13,3858	140 5,5118	200 7,874	1610	3300	1,5	3	50,5	TDI 332873
234,95 9,25	327,025 12,875	93,662 3,6875	93,662 3,6875	821	2110	1,5	3,3	25,5	TDI 332492 (8576DW-8500)
240 9,4488	480 18,8976	220 8,6814	200 7,874	3260	5460	2,5	5	183,0	TDI 332931
254 10	358,775 14,125	130,175 5,125	130,175 5,125	1490	3510	1,5	3,3	43,5	TDI 332296 (M 249749D-710)
	438,15	165,1	165,1	2410	4170	3,3	6,4	100,0	TDI 332536 (EE 738101DW-172)
	17,25	6,5	6,5						
269,875 10,625	381 15	136,525 5,375	136,525 5,375	1590	3700	3,3	3,3	51,0	TDI 331223 (M 252349DW-310)
279,587 11,007	380,898 14,996	117,475 4,625	117,475 4,625	1180	3180	1,5	3,3	41,5	TDI 332899 (LM 654644D-610)
288,925 11,375	406,4 16	165,1 6,5	234,95 9,25	2160	4830	1,6	3,2	73,0	TDI 332870

Main dimensions				Basic load ratings		Dimensions		Mass	Designation
d	D	T	B	Dynamic C	Static C ₀	r _{1,2min}	r _{3,4min}		(AFBMA part number)
[mm/in]				[kN]		[mm]		[kg]	-
300,038 11,8125	422,275 16,625	150,812 5,9375	150,812 5,9375	1980	4690	3,3	3,3	70,0	TDI 331951 (HM 256849DW-810)
303,212 11,9375	495,3 19,5	263,525 10,375	263,525 10,375	4470	9790	3,3	6,4	212,0	TDI 332685 (HH 258249TD-210)
317,5 12,5	422,275 16,625	128,588 5,0625	128,588 5,0625	1630	4080	1,5	3,3	51,5	TDI 328699 (LM 528648DW-610)
333,375 13,125	469,9 18,5	166,688 6,5625	166,688 6,5625	2370	5600	3,3	3,3	92,5	TDI 328695 (HM 261049TD-010)
	469,9 18,5	166,688 6,5625	231,775 9,125	2370	5600	1,6	3,3	98,0	TDI 332871
342,9 13,5	533,4 21	139,7 5,5	146,05 5,75	2300	4380	3,3	3,3	115,0	TDI 331713 (EE 971355DW-100)
343,052 13,506	457,098 17,996	122,238 4,8125	122,238 4,8125	1460	3370	1,5	3,3	54,0	TDI 332240 (LM 761649DW-600)
346,075 13,625	488,95 19,25	104,775 4,125	95,25 3,75	1140	2710	1,5	6,4	62,0	TDI 332913 (EE 161362D-925)
	488,95 19,25	174,625 6,875	174,625 6,875	2490	5980	3,3	3,3	110,0	TDI 331527 (HM 262749D-710)
	488,95 19,25	174,625 6,875	174,625 6,875	2540	6180	3,3	3,3	113,0	TDI 328410 (HM 262749TD-710)
360 14,1732	680 26,7717	330 12,9921	300 11,811	7060	13200	4	7,5	540,0	TDI 331729
368,3 14,5	523,875 20,625	185,738 7,3125	185,738 7,3125	3030	7410	3,3	6,4	133,0	TDI 331836 (HM 265049D-010)
	523,875 20,625	185,738 7,3125	185,738 7,3125	3030	7410	3,3	6,4	140,0	TDI 332468 (HM 265049TD-010)
	596,9 23,5	165,1 6,5	158,75 6,25	2960	5740	6,4	6,4	160,0	TDI 331905
384,175 15,125	546,1 21,5	193,675 7,625	193,675 7,625	3370	8290	3,3	6,4	152,0	TDI 331158 (HM 266449DW-410)
	546,1 215000	193,675 7,625	193,675 7,625	3370	8290	3,3	6,4	166,0	TDI 328580 (HM 266449TD-410)

Double row tapered roller bearings

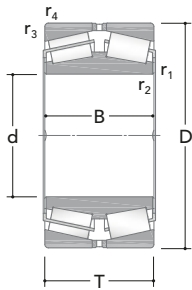

TDI

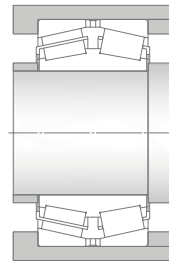

Main dimensions				Basic load ratings		Dimensions		Mass	Designation
d	D	T	B	Dynamic C	Static C ₀	r _{1,2min}	r _{3,4min}		(AFBMA part number)
[mm/in]				[kN]		[mm]		[kg]	-
546,1 21,5	193,675 7,625	193,675 7,625		3370	8290	3,3	6,4	152,0	TDI 331837 (HM 266449D-410)
390 15,3543	546,1 21,5	141,288 5,5625	141,288 5,5625	2120	5080	3,3	6,4	102,0	TDI 328705
406,4 16	546,1 21,5	138,113 5,4375	138,113 5,4375	2150	5090	1,5	6,4	89,0	TDI 331840 (LM 767749DW-710)
408,4 16,0787	546,1 21,5	120 4,7244	98 3,8583	1470	3400	1	3	76,5	TDI 328874
	546,1 21,5	150 5,9055	125 4,9213	1780	4680	1,5	3,3	99,0	TDI 328466
409,575 16,125	546,1 21,5	161,925 6,375	161,925 6,375	2430	6480	1,5	6,4	110,0	TDI 331714 (M 667947DW-910)
415,925 16,375	590,55 23,25	209,55 8,25	209,55 8,25	3790	9550	3,3	6,4	192,0	TDI 328283 (M 268749TDW-710)
	590,55 23,25	209,55 8,25	209,55 8,25	3790	9550	3,3	6,4	192,0	TDI 331445 (M 268749TDW-710)
430 16,9291	535 21,063	84 3,3071	84 3,3071	1040	2970	1	3	44,5	TDI 334013
447,625 17,625	635 25	223,838 8,8125	223,838 8,8125	4300	10970	3,3	6,4	236,0	TDI 331562 (M 270749DW-710)
	635 25	223,838 8,8125	223,838 8,8125	4300	10970	3,3	6,4	246,0	TDI 332911 (M 270749TD-710)
450 17,7165	595 23,4252	178 70,0079	178 70,0079	2870	8120	3	6	140,0	TDI 328523 (M 270449DA-410)
464 18,2677	615,95 24,25	150 5,9055	136 5,3543	2070	5730	1,5	4	125,0	TDI 328361
489,026 19,253	634,873 24,995	152,4 6	152,4 6	2670	7300	3,3	3,3	130,0	TDI 331848 (EE 243193D-250)
491 19,3307	635 25	148 5,8268	128 5,0394	1830	5210	1,5	3,3	120,0	TDI 328381

Main dimensions				Basic load ratings		Dimensions		Mass	Designation (AFBMA part number)
d	D	T	B	Dynamic C	Static C ₀	r _{1,2min}	r _{3,4min}		
[mm/in]				[kN]		[mm]		[kg]	-
500 19,685	730 28,7402	280 11,0236	280 11,0236	6400	15450	3	6	420,0	TDI 331676
501,65 19,75	673,1 26,5	184,15 7,25	184,15 7,25	3810	9590	3,3	6,4	190,0	TDI 332547
	711,2 28	250,825 9,875	250,825 9,875	5290	13590	3,2	6,4	330,0	TDI 331182 (M 274149DW-110)
519,112 20,4375	736,6 29	258,762 10,1875	258,762 10,1875	5860	15580	3,3	6,4	370,0	TDI 332662 (M 275349D-310)
	736,6 29	258,762 10,1875	258,762 10,1875	5860	15580	3,3	6,4	370,0	TDI 334009 (M 275349TD-310)
522 20,5512	690 27,1653	180 7,0866	160 6,2992	2780	8170	1,5	4	190,0	TDI 328359
536,575 21,125	761,873 29,995	269,875 10,625	269,875 10,625	6090	15710	3,3	6,4	410,0	TDI 331682 (M 276448DW-410)
558,8 22	736,6 29	196,85 7,75	196,85 7,75	4180	11430	3,3	6,4	235,0	TDI 331607 (LM 377448DW-410)
560 22,0472	820 32,2835	242 9,5276	242 9,5276	4880	11230	2,5	8	425,0	TDI 332626
571,5 22,5	812,8 32	285,75 11,25	285,75 11,25	7020	17700	3,3	6,4	500,0	TDI 331476 (M 278749DW-710)
	812,8 32	285,75 11,25	285,75 11,25	6940	17690	3,3	6,4	500,0	TDI 331854 (M 278749D-710)
580 22,8346	830 32,6772	280 11,0236	280 11,0236	6620	16280	3	6	515,0	TDI 331677
609,6 24	787,4 31	171,45 6,75	171,45 6,75	3890	10590	3,3	6,4	218,0	TDI 331858 (EE 649241D-310)
	820 32,2835	171,45 6,75	171,45 6,75	3930	10460	3,3	6,4	265,0	TDI 332424
650 25,5906	1030 40,5512	270 10,6299	270 10,6299	8450	18120	15	10	900,0	TDI 328306

Double row tapered roller bearings

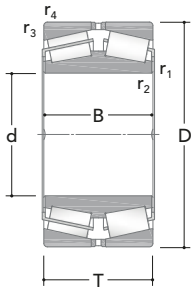

TDI

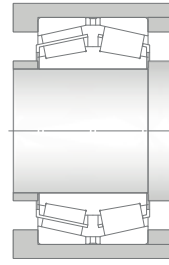

Main dimensions				Basic load ratings		Dimensions		Mass	Designation (AFBMA part number)
d	D	T	B	Dynamic C	Static C ₀	r _{1,2min}	r _{3,4min}		
[mm/in]				[kN]		[mm]		[kg]	-
660,4 26	812,8 32	176,212 6,9375	176,212 6,9375	3450	11140	3,2	6,4	195,0	TDI 331198
682,625 26,875	965,2 38	338,138 13,3125	338,138 13,3125	9200	24670	3,3	6,4	815,0	TDI 332129 (M 282249D-210)
710 27,9528	900 35,4331	197 7,7559	197 7,7559	4560	13010	3	6	325,0	TDI 331581
800 31,496	1260 49,6063	375 14,7638	375 14,7638	14240	33470	12	12	1850,0	TDI 334032
863,6 34	1130,3 44,5	323,85 12,75	323,85 12,75	10360	30610	4,8	12,7	895,0	TDI 331590 (LM 286249D-210)
901,7 35,5	1295,4 51	450,85 17,75	438,15 17,25	16250	42470	4,8	12,7	2000,0	TDI 331306 (EE 634356DGW-510)
939,8 37	1333,5 52,5	463,55 18,25	463,55 18,25	16980	48760	4,8	12,7	2230,0	TDI 331350 (LM 287849DW-810)

Double row tapered roller bearings

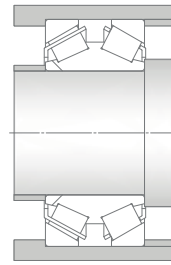
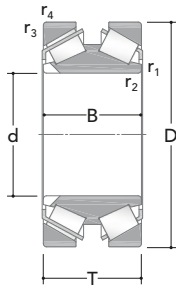

TDIS

Main dimensions				Basic load ratings		Dimensions		Mass	Designation
d	D	T	B	Dynamic C	Static C ₀	r _{1,2min}	r _{3,4min}		
[mm]				[kN]		[mm]		[kg]	-
300	440	105	105	976	2030	4	4	48,5	TDIS 332168
305,033	560	200	200	2820	5270	3,3	6,4x45°	205,0	TDIS 334087
305,07	500	200	200	2490	5190	6,4	4,8	150,0	TDIS 332169
	560	200	200	2820	5230	3,3	6	200,0	TDIS 332068
	560	200	200	2810	5210	3,3	18	200,0	TDIS 331617
360	560	160	160	2320	4630	3	5	140,0	BT2-8000
	600	200	200	2910	5790	3,0	5	220,0	BT2-8002
380	560	200	200	2720	6470	5	5	165,0	BT2-8009
	565	200	200	2740	6460	5,0	5	170,0	BT2-8003
386	574	220	220	2650	6460	3	5	185,0	BT2-8010
390	570	200	200	2670	6430	5,0	5	170,0	TDIS 328896
400	650	240	240	3790	8070	6,4	6,4	245,0	332167
	650	240	240	3790	8070	6,4	6,4	245,0	TDIS 332167
408,4	546,1	152	160	1450	3420	1	3	88,0	TDIS 334053
445	620	160	160	2040	5030	2,0	5	135,0	TDIS 334069
460	680	180	180	3070	6860	2,5	6	210,0	TDIS 328876
510	733,5	200,025	200,025	3490	8460	3,3	4,8	265,0	TDIS 617670
510,13	800	285	285	5470	12600	4,8	10	505,0	TDIS 332171
520	660	140	140	1970	5600	3	5	115,0	BT2-8001
635	939,8	304,8	304,8	6470	16300	3,3	6,4	720,0	TDIS 331555
800	1100	300	300	7350	21100	1,5	6	850,0	TDIS 332394
305,07	524	200	200	2450	5160	6,4	4,8	180,0	TDIS 334110
	524	220	220	2460	5170	6,4	4,8	195,0	BT2-8006

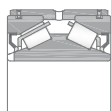
TDISS

Main dimensions				Basic load ratings		Dimensions		Mass	Designation (AFBMA part number)
d	D	T	B	Dynamic C	Static C ₀	r _{1,2min}	r _{3,4min}		
[mm]				[kN]		[mm]		[kg]	-
320	524	185	185	2460	5170	3,0	4,8	150,0	TDIS 334152
	540	160	160	2170	4360	2	5	160,0	BT2-8017
390	568	180	180	2300	5730	2,0	5	155,0	TDIS 334045
	590	200	200	2670	6500	5	5	200,0	TDIS 328934
	590	220	220	2690	6540	3,0	5	210,0	BT2-8011
	615,95	220	220	2640	6420	3	5	250,0	BT2-8014
406,4	566,1	150	150	1760	4710	1,5	3,3	120,0	TDIS 334024
	580	164,275	164,275	1780	4680	1,5	5	135,0	TDIS 334085
408,4	570,1	152	160	1470	3430	1,0	3	115,0	TDIS 334068
420	620	200	200	2880	7070	2	5	210,0	BT2-8016
440	615,95	220	220	2040	5060	2,0	5	185,0	BT2-8013
445	620	180	180	2050	5000	2	5	160,0	TDIS 334113
450	702	180	180	3030	6920	2,5	6	260,0	BT2-8018
460	702	180	180	3050	6830	2,5	6	250,0	TDIS 334030
480	660	150	150	1710	5160	2,0	5	160,0	TDIS 334100
482	640	160	160	1690	5170	2	5	145,0	TDIS 334112
	640	160	160	1660	4180	2,0	5	130,0	TDIS 334111
520	715	180	180	2750	8140	1,5	4	220,0	TDIS 334041

Four-row tapered roller bearings

RKB four-row tapered roller bearings are produced mainly in TQO and TQI configuration, in open and sealed version. Supplied with the required axial internal clearance, they are mainly employed on work rolls of rolling mill applications.

The use of high quality raw materials, special heat treatments, and innovative sealing solutions are at the base of their higher operating reliability and longer service life expectancy. The bearing dimensional and running accuracy conforms to ISO/ABMA/GOST specifications.



Bearing internal clearance

RKB four-row tapered roller bearings are normally provided in set right ready for mounting featuring a proper Bench End Play (BEP) suitable to the specific application. According to this concepts, bearing components have to be mounted strictly following a sequence and cannot be swapped each other nor used among different bearings. In order to establish the proper BEP specification for your applications, please contact the RKB application engineering services.

Minimum load

In order to get a correct functioning, double row tapered roller bearings have to be always loaded with a minimum value, in particular in case of application featuring high speed, high acceleration and/or quick variation of load direction. According to the above condition the minimum required load can be evaluated as following:

$$\frac{F_{rm}}{C} > 0,02$$

where:

- F_{rm} minimum radial load, [kN];
- C dynamic load rating, [kN].

Designs and variants

Type TQO₁

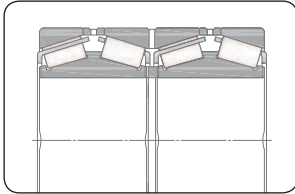

- One double cup, two single cups, plus two cup spacers (plain or with lubrication grooves and holes)
- Two double cones, plus one cone spacer (plain or with lubrication holes)
- Four one-piece window type steel cages
- Supports radial and axial loads in both directions
- Preset or adjusted BEP on customer's request
- Available with helical groove in the bore (G)
- Marked zones on cups side face to easy mounting and maintenance operations
- Available in metric and inch sizes
- Optimized roller profile

- Marked zones on cups side face to easy mounting and maintenance operations
- Available in metric and inch sizes
- Optimized roller profile

Type TQO₃

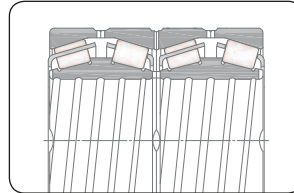

- One double cup, two single cups
- Two double cones
- Four one-piece window type pressed steel cages
- Supports radial and axial loads in both directions
- Available with helical groove in the bore (G)
- Lubrication grooves in double cone side faces
- Marked zones on cups sides face to easy mounting and maintenance operations
- Available in metric and inch sizes
- Optimized roller profile

Type TQO₂

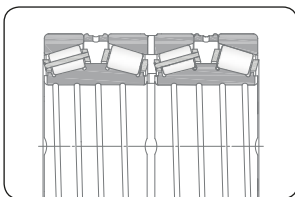

- One double cup, two single cups, plus two cup spacers (plain or with lubrication grooves and holes)
- Two double cones, plus one cone spacer (plain or with lubrication holes)
- Four two-piece steel pin type cages
- Pierced roller execution to increase load rating capacities
- Preset or adjusted BEP on customer's request
- Available with helical groove in the bore (G)

Type SET2xTDI

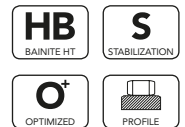
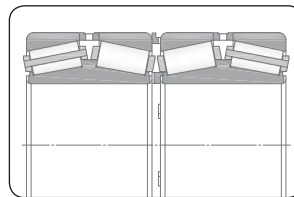

- Four ribless cups plus three spacers (plain or with lubrication grooves and holes)
- Two double cones with three ribs
- Four pin type cages
- Preset or adjusted BEP on customer's request
- Marked zones on cups side face to easy mounting and maintenance operations
- Available in metric and inch sizes
- Better internal distribution of the external

Four-row tapered roller bearings

loads due to the four single cups compared with TQO design

- Optimized roller profile

Type TQIT

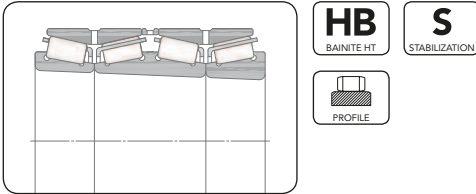

- Two double cup, plus one cup spacer (plain or with lubrication grooves and holes)
- One double cone, two single cones
- Four one-piece window type steel cages
- Preset or adjusted BEP on customer's request
- Available with helical groove in the bore (G)
- Available with cylindrical (TQI) or tapered bore (TQIT)
- Marked zones on cups side face to easy mounting and maintenance operations
- Available in metric and inch sizes
- Optimized roller profile

Type TQOT

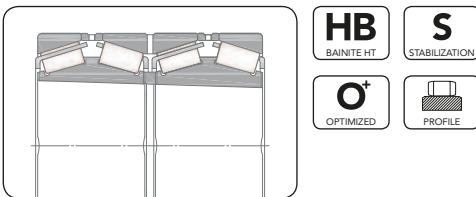

- One double cup, two single cups, plus two cup spacers (plain or with lubrication grooves and holes)
- Two two double cones, plus one cone spacer (plain or with lubrication holes)
- Four one-piece window type steel cages
- Supports radial and axial loads in both directions
- Preset or adjusted BEP on customer's request
- Tapered bore

- Marked zones on cups side face to easy mounting and maintenance operations
- Available in metric and inch sizes
- Optimized roller profile

Type TQOS₁

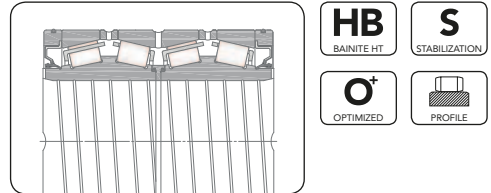

- One double cup, two single cups, plus two cup spacers (plain or with lubrication grooves and holes)
- Two double cones
- Four one-piece window type steel cages
- Preset or adjusted BEP on customer's request
- Marked zones on cups side face to facilitate mounting and maintenance operations
- Lateral flanges with lip seals and o-rings on bearing both sides
- Designed with Anti-Vortex System cone spacer seal set
- Available in metric and inch sizes
- Optimized roller profile

Type TQOS₂

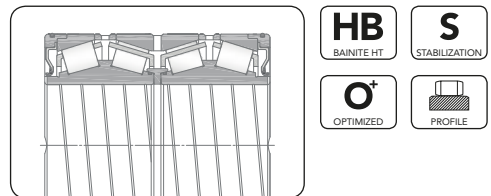

- One double cup, two single cups plus two cup spacers (plain or with lubrication grooves and holes)
- Two double cones with three ribs
- Four one-piece window type steel cages
- Preset or adjusted BEP on customer's request
- Marked zones on cups side faces to easy

mounting and maintenance operations

- Lateral flanges, concentric to the single cups, with improved seal lip and O-rings
- Designed with Anti-Vortex System cone spacer seal set
- Available in metric and inch sizes
- Optimized roller profile

Type TQOS₃

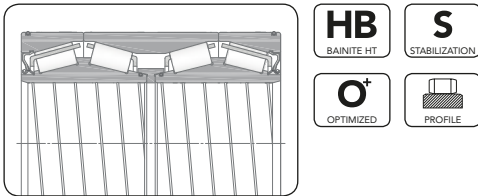

- One double cup, two single cups with integrated lateral flanges, featuring O-ring and rotating lip seals
- Two double cones with three ribs
- Four one-piece window type steel cages
- Preset or adjusted BEP on customer's request
- Marked zones on cups side face to easy mounting and maintenance operations
- Designed with Anti-Vortex System cone spacer seal set
- Available in metric and inch sizes
- Completely sealed (re-lubrication process is not possible!)
- Optimized roller profile

Four-row tapered roller bearings

Suffixes	Internal design
B	In TQO bearings, special double cones width. The number immediately following the B gives the double cones width in mm
SP	Special or non-standard bearing
BT4B	Four-row tapered roller bearing
ZB	Optimized roller profile for improved load distribution. It is not necessarily stated in the bearing code

Suffixes	Accuracy, clearance, running
HP	High precision (better than P6)
ST	Special tolerance

Suffixes	External design
AVSx	Anti-vortex system
AVSxC	Anti-vortex system with compact seals
1C	Compact seal and O-ring on both sides

Four-row tapered roller bearings

Part numbering

First system

	Section 1	Section 2	Section 3	Section 4	Section 5
	Configuration	Boundary dimensions	Execution	Material and heat treatment of bearing components	Special surface treatment
	TQO, TQI, TQIT, TQOS, TQOE, TQITE, TQOT	dxDxT/DxTxd	A1...An, AA, AB, AD, AC1, A1B etc. indicating major or minor revision based on: customer's request; application requirement, echnology or design advancement, presence of special features. The meaning of such combination of characters and numbers may vary from bearing to bearing	HB1...HB7 HA1...HA7	PT1...PT7 AWT1...AWT7 ACT1...ACT3
Example	TQO	101510/506250	AA2	PT4	HA4
		d: 10,50 inches = 266,700 mm D: 15,50 inches = 393,700 mm T: 10,62 inches = 269,748 mm	As basic TQO configuration, but with special benh end play	Phosphate treated cones, cup and rollers	Case hardened bearing components

Tab. 19 (1 of 2) - Frist system: structure

Section 6	Section 7	Section 8	Section 9	Section 10
Roller features	Final bearing specification	K	$r_{1,2 \text{ min}}$ $r_{3,4 \text{ min}}$	Suffix
ZB	BT4B	The three figures immediately following the K indicates the K thrust value without a decimal mark	The four figures immediately following the three digits of the K value indicate the minimum values in mm of radii 1,2 and 3,4 without decimal marks	Different features from standard version
ZB	BT4B	K145	3364	VL
Optimized roller profile for improved load distribution	Four-row tapered roller bearing	K: 1,45	$r_{1,2 \text{ min}}$: 3,3 mm $r_{3,4 \text{ min}}$: 6,4 mm	Victory Line

Tab. 19 (2 of 2) - First system: structure

Four-row tapered roller bearings

Second system

	Section 1 Configuration	Section 2 Drawing number	Section 3 Execution	Section 4 Material and heat treatment of bearing components
	TQO, TQI, TQIT, TQOS, TQOE, TQITE, TQOT	Up to six digits	A1...An, AA, AB, AD, AE1, A1B etc. indicating major or minor revision based on: customer's request, application requirement, technology or design advancement, presence of special features. Typically the meaning of such combination of alphabetical and numerical characters vary from bearing to bearing	HB1...HB7 HA1...HA7
Example	TQIT	101411	AA	HB4
		No dimension indication	As basic TDI configuration, but with lubrication grooves in side faces of double cone	Bainite hardened bearing components

Tab. 20 (1 of 2) - Second system: structure

Section 5	Section 6	Section 7	Section 8
Special surface treatment	Roller features	Final bearing specification	Suffix
PT1...PT7 AWT1...AWT7 ACT1...ACT3	ZB	BT4B	Different features from standard version
ACT1	ZB	BT4B	VL
Anticorrosion treated	Optimized roller profile for improved load distribution	Four-row tapered roller bearing	Victory Line

Tab. 20 (2 of 2) - Second system: structure

Four-row tapered roller bearings

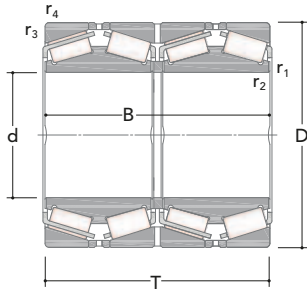

TQO1

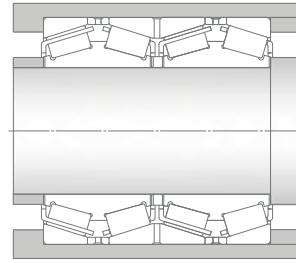

Main dimensions				Basic load ratings		Dimensions		Mass	Designation
d	D	T	B	Dynamic C	Static C ₀	r _{1,2min}	r _{3,4min}		(AFBMA part number)
[mm/in]				[kN]		[mm]		[kg]	-
120,65 4,75	174,625 6,875	139,703 5,5001	141,288 5,5625	717	1530	0,8	1,5	11	TQO 332406 (M 224749DW-710-710D)
127 5	182,562 7,1875	158,75 6,25	158,75 6,25	751	1720	1,5	3,3	14	TQO 330880 (48290DW-220-220D)
139,7 5,5	200,025 7,875	160,338 6,3125	157,162 6,1875	832	2030	0,8	3,3	15,5	TQO 331138 (48685D-620-620D)
152,4 6	222,25 8,75	174,625 6,875	174,625 6,875	1080	2460	1,5	1,5	22,5	TQO 331329 (M 231649DW-610-610D)
165,1 6,5	225,425 8,875	168,275 6,625	165,1 6,5	835	2160	0,8	3,3	20,5	TQO 330835 (46791DW-720-721D)
177,8 7	247,65 9,75	192,088 7,5625	192,088 7,5625	1180	2980	1,5	3,3	29	TQO 331480 (67790DW-720-721D)
187,325 7,375	269,875 10,625	211,138 8,3125	211,138 8,3125	1600	3760	1,5	3,3	41	TQO 331382 (M 238849DW-810-810D)
	269,875 10,625	211,138 8,3125	211,138 8,3125	1600	3760	1,5	3,3	41	TQO 328881 (M 238849DW-810-810D)
190,5 7,5	266,7 10,5	188,912 7,4375	187,325 7,375	1290	3220	1,5	3,3	33,5	TQO 331249 (67885DW-820-820D)
198,438 7,8125	284,162 11,1875	225,425 8,875	225,425 8,875	1740	4090	1,5	3,3	47,5	TQO 330899 (M 240648DW-611-611D)
205 8,0709	320 12,5984	203,5 8,0118	203,5 8,0118	1840	3640	4	3	54,5	TQO 328065
206,375 8,125	282,575 11,125	190,5 7,5	190,5 7,5	1250	3300	0,8	3,3	36,5	TQO 331486 (67985DG-920-921D)
220 8,6614	320 12,5984	200 7,874	200 7,874	1710	3980	1	3	54	TQO 328348/HA1
	340 13,3858	303,5 11,9488	303,5 11,9488	3010	6690	4	3	100	TQO 328003/HA1

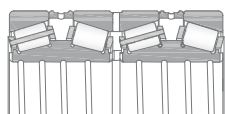
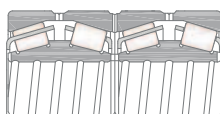
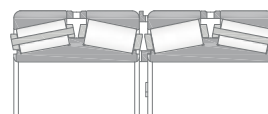

TQO2

TQO3

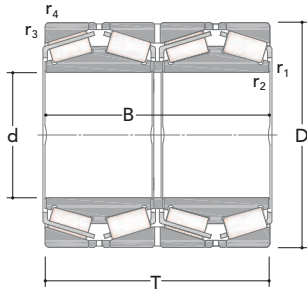
SET2xTDI

Main dimensions				Basic load ratings		Dimensions		Mass	Designation
d	D	T	B	Dynamic C	Static C ₀	r _{1,2min}	r _{3,4min}		(AFBMA part number)
[mm/in]				[kN]		[mm]		[kg]	-
220,662 8,6875	314,325 12,375	239,712 9,4375	239,712 9,4375	2140	5110	1,5	3,3	61,5	TQO 331156 (M 244249DW-210-210D)
228,6 9	311,15 12,25	200,025 7,875	200,025 7,875	1710	4020	1,5	3,3	43,5	TQO 332637 (LM 245149DW-110-110D)
234,95 9,25	327,025 12,875	196,85 7,75	196,85 7,75	1480	4160	1,5	3,3	54	TQO 331399 (8576DW-20-20D)
240 9,4488	338 13,3071	248 9,7638	248 9,7638	2320	5430	4	3	70	TQO 328015
	360 14,1732	218 8,5827	218 8,5827	2380	4700	1,5	4	75,5	TQO 328663
	360 14,1732	308,5 12,1457	308,5 12,1457	3210	7240	4	3	110	TQO 328508
241,224 9,497	355,498 13,996	228,6 9	228,6 9	2070	4950	1,5	3,3	81,5	TQO 331787 (EE 127094DW-138-139D)
241,478 9,507	349,148 13,746	228,6 9	228,6 9	2080	4920	1,5	3,3	74,5	TQO 330782 (EE 127097DW-135-136D)
244,475 9,625	327,025 12,875	193,675 7,625	193,675 7,625	1770	4290	1,5	3,3	46	TQO 330862 (LM 247748D-710-710D)
	381 15	304,8 12	304,8 12	2860	6580	3,3	4,8	130	TQO 328690/HA1 (EE 126096DW-150-151D)
245 9,6457	380 14,9606	254 10	255,5 10,0591	2560	5560	1,5	4	105	TQO 331398
247,65 9,75	400,05 15,75	253,995 9,9998	249,235 9,8124	2850	6290	1,5	6,4	120	TQO 614096 (EE 220975DW-1575-1576D)
254 10	358,775 14,125	269,875 10,625	269,875 10,625	2790	7080	1,5	3,3	88	TQO 331275 (M 249749DW-710-710D)
	358,775 14,125	269,875 10,625	339,725 13,375	2790	7080	1,5	3,3	92,5	TQO 329070
260 10,2362	440 17,3228	298,5 11,725	298,5 11,725	3820	7260	2,5	5	190	TQO 328551

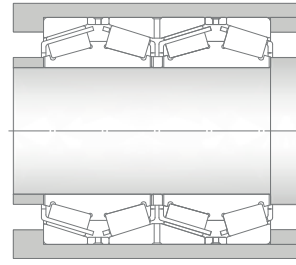
Four-row tapered roller bearings



TQO1



Main dimensions				Basic load ratings		Dimensions		Mass	Designation
d	D	T	B	Dynamic C	Static C ₀	r _{1,2min}	r _{3,4min}		(AFBMA part number)
[mm/in]				[kN]		[mm]		[kg]	-
260,35	422,275	317,5	314,325	4010	7940	6,4	3,3	180	TQO 331487
10,25	16,625	12,5	12,375						(HM 252349DGW-310-310D)
266,7	355,6	228,6	230,188	2110	5500	1,5	3,3	65,5	TQO 330822
10,5	14	9	9,0625						(76589DW-520-520D)
	355,6	228,6	230,188	2110	5500	1,5	3,3	65,5	TQO 328209
	14	9	9,0625						(LM 451349DW-310-310D)
269,875	381	282,575	282,575	3010	7410	3,3	3,3	105	TQO 331168
10,625	15	11,125	11,125						(M 252349OW-310-310O)
276,225	393,7	269,875	269,878	2860	6370	1,5	6,4	100	TQO 331288
10,875	15,5	10,625	10,6251						(EE 275109D-155-156D)
279,4	381	269,875	269,875	2800	7430	1,5	3,3	91	TQO 328293
11	15	10,625	10,625						
	393,7	269,875	269,875	2950	6990	1,5	6,4	102	TQO 332390
	15,5	10,625	10,625						(EE 135111DW-155-156D)
279,578	380,898	244,475	244,475	2200	6270	1,5	3,3	86	TQO 330540
11,007	14,996	9,625	9,625						(LM 654644DW-610-610D)
280	380	290	290	2960	7890	1	2,5	95	TQO 328613
11,0236	14,9606	11,4173	11,4173						
	380	290	290	2870	7700	2,2	4,3	95,5	TQO 328681
	14,9606	11,4173	11,4173						
	395	288	288	3390	8290	2,5	4	110	TQO 328807
	15,5512	11,3386	11,3386						
	395	288	288	2820	7470	2	6	115	TQO 328882
	15,5512	11,3385	11,3385						
	420	250	250	3070	6500	2	5	115	TQO 328664
	16,5354	9,8425	9,8425						
	460	324	324	4560	9160	6	6	215	TQO 332441
	18,1102	12,7559	12,7559						
285,75	380,898	244,475	244,475	2200	6350	1,5	3,3	81	TQO 330337
11,25	14,996	9,625	9,625						(LM 654648DW-610-610D)
288,925	406,4	298,45	298,45	3480	8840	3,3	3,3	125	TQO 331452
11,375	16	11,75	11,75						(M 255449DW-410-410D)

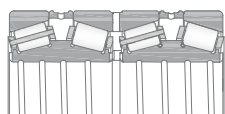
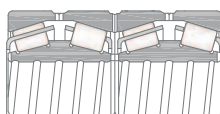
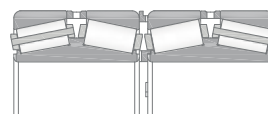

TQO2

TQO3

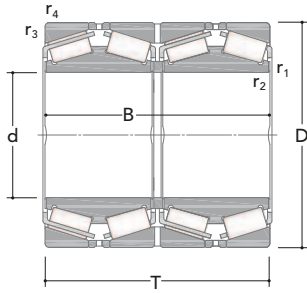
SET2xTDI

Main dimensions				Basic load ratings		Dimensions		Mass	Designation
d	D	T	B	Dynamic C	Static C ₀	r _{1,2min}	r _{3,4min}		(AFBMA part number)
[mm/in]				[kN]		[mm]		[kg]	-
292,1 11,5	422,275 16,625	269,875 10,625	269,875 10,625	3400	7970	6,4	3,3	125	TQO 331968 (EE 330116DGW-166-167D)
300 11,811	440 17,3228	279,4 11	280,988 11,0625	3070	7750	3,3	4,8	145	TQO 328725
	460	388,5	388,5	5220	12360	5	5	240	TQO 332472
	18,1102	15,2953	15,2953						
300,038 11,8125	422,275 16,625	311,15 12,25	311,15 12,25	3660	9350	3,3	3,3	140	TQO 331287 (HM 256849DGW-810-810D)
304,648 11,994	438,048 17,246	279,4 11	280,99 11,0625	2960	6890	2x15°	4,8	135	TQO 328828
	438,048	279,4	280,99	3390	7990	3,3	4,8	135	TQO 331492 (M 757448DGW-410-410D)
	17,246	11	11,0625						
304,8 12	419,1 16,5	269,875 10,625	269,875 10,625	3270	8090	1,5	6,4	110	TQO 331687 (M 257149DW-110-110D)
	482,6	377,825	365,125	4900	10270	3,3	3,3	265	TQO 330693
	19	14,875	14,375						
304,902 12,004	412,648 16,246	266,7 10,5	266,7 10,5	2980	7990	3,3	3,3	105	TQO 330758 (M 257248DW-210-210D)
317,5 12,5	422,275 16,625	269,875 10,625	269,875 10,625	3000	8040	1,5	3,3	105	TQO 330870 (LM 258648DGW-610-610D)
	438,15	276,225	276,225	3440	8190	1,5	3,3	125	TQO 334020
	17,25	10,875	10,875						
	447,675	327,025	327,025	4240	10640	3,3	3,3	165	TQO 331161 (HM 259049DGW-010-010D)
	17,625	12,875	12,875						
330,2 13	444,5 17,5	301,625 11,875	301,625 11,875	3540	9460	3,3	3,3	135	TQO 332647 (M 260149DGW-110-110D)
330,302 13,004	438,023 17,245	254 10	247,65 9,75	2510	7240	1,5	3,3	110	TQO 331664 (EE 138131DGW-172-173D)
333,375 13,125	469,9 18,5	342,9 13,5	342,9 13,5	4470	11270	3,3	3,3	190	TQO 331381 (HM 261049DGW-010-010D)

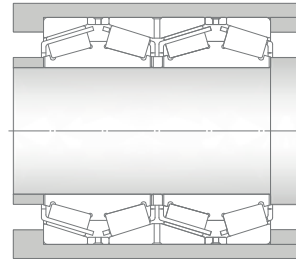
Four-row tapered roller bearings



TQO1



Main dimensions				Basic load ratings		Dimensions		Mass	Designation
d	D	T	B	Dynamic C	Static C ₀	r _{1,2min}	r _{3,4min}		(AFBMA part number)
[mm/in]				[kN]		[mm]		[kg]	-
340 13,3858	520 20,4724	323,5 12,7362	323,5 12,7362	5090	10220	1,5	5	245	TQO 332963
342,9 13,5	571,5 22,5	342,9 13,5	342,54 13,4858	6060	11570	3,3	6,4	365	TQO 331553
343,052 13,506	457,098 17,996	254 10	254 10	2740	6780	1,5	3,3	110	TQO 330661 (LM 761649DG-610-610D)
346,075 13,625	488,95 19,508	358,775 14,125	358,775 14,125	4800	12390	3,3	3,3	220	TQO 331228 (HM 262749D-710-710D)
347,662 13,6875	469,9 18,5	260,35 10,25	260,35 10,25	3660	10150	1,5	3,3	130	TQO 331077 (LM 262449DGW-410-410D)
	469,9 18,5	292,1 11,5	292,1 11,5	3660	10030	3,3	3,3	150	TQO 331092 (M 262449DGW-410-410D)
355 13,9764	490 19,2913	316 12,4409	316 12,4409	4000	10990	1,5	3,3	185	TQO 331508
355,6 14	482,6 19	269,875 10,625	265,112 10,4375	3120	7980	1,5	3,3	140	TQO 330662 (LM 763449DGW-410-410D)
	488,95 19,25	317,5 12,5	317,5 12,5	4040	10980	1,5	3,3	195	TQO 331271 (M 263349DGW-310-310D)
360 14,1732	510 20,0787	380 14,9606	380 14,9606	5450	14180	2	6	255	TQO 332059
	540 21,26	280 11,0236	280 11,0236	4250	8970	5	5	230	TQO 328159
368,3 14,5	523,875 20,625	382,588 15,0625	382,588 15,0625	5630	14780	3,3	6,4	275	TQO 331159 (HM 265049DGW-010-010D)
374,65 14,75	501,65 19,75	260,35 10,25	250,825 9,875	3240	8040	1,5	3,3	140	TQO 332188 (LM 765149DGW-110-110D)
380 14,9606	560 22,0472	325 12,7953	325 12,7953	5330	11570	2	5	265	TQO 328294
	560 22,0472	360 14,1732	360 14,1732	5960	13540	2	6	295	TQO 328816

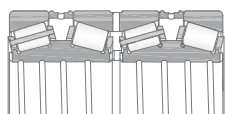

TQO2

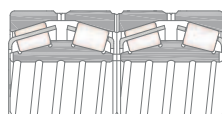

TQO3

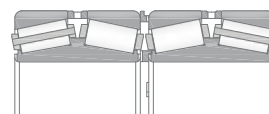

SET2xTDI

Main dimensions				Basic load ratings		Dimensions		Mass	Designation
d	D	T	B	Dynamic C	Static C ₀	r _{1,2min}	r _{3,4min}		(AFBMA part number)
[mm/in]				[kN]		[mm]		[kg]	-
380 14,9606	620 24,4094	368 15,2165	368 15,2165	6780	13480	6	6	438	TQO 332889
384,175 15,125	546,1 21,5	400,05 15,75	400,05 15,75	6220	16360	3,3	6,4	310	TQO 331149 (HM 266449DGW-410-410D)
385,762 15,1875	514,35 20,25	317,5 12,5	317,5 12,5	4180	11930	3,3	3,3	190	TQO 331202 (LM 665949DGW-910-910D)
395 15,5512	545 21,4567	288,9 11,374	268 10,5512	3780	9470	5	10	195	TQO 332824
406,4 16	546,1 21,5	288,925 11,375	268,288 10,5625	3790	9410	1,5	6,4	185	TQO 331465 (EE 234161DGW-215-216D)
	546,1 21,5	288,925 11,375	288,925 11,375	3920	10170	1,5	6,4	185	TQO 330650 (LM 767749DGW-710-710D)
	565,15 22,25	381 15	381 15	5890	15520	3,3	6,4	300	TQO 331347 (M 267949DGW-910-910D)
	590,55 23,25	400,05 15,75	400,05 15,75	6690	16530	3,3	6,4	370	TQO 331133 (EE 833161 DGW-232-233D)
409,575 16,125	546,1 21,5	334,962 13,1875	334,962 13,1875	4560	13000	1,5	6,4	220	TQO 331333 (M 667947DA-910-910D)
	546,1 21,5	334,962 13,1875	334,962 13,1875	4300	12310	6,4	6,4	220	TQO 328967
415,925 16,375	590,55 23,25	434,975 17,125	434,975 17,125	6930	18960	3,3	6,4	395	TQO 331160 (M 268749DGW-710-710D)
420 16,5354	560 22,0473	437 17,2047	437 17,2047	5650	16290	4	6	285	TQO 328826
	620 24,4094	355 13,9764	355 13,9764	6210	14370	2	5	375	TQO 328374
430 16,9229	570 22,4409	336,55 13,25	336,55 13,25	4770	13920	1,5	3,3	240	TQO 331192
431,8 17	571,5 22,5	279,4 11	279,4 11	3580	9470	1,5	3,3	200	TQO 331125 (LM 869449DGW-410-410D)
	571,5 22,5	279,4 11	279,4 11	3580	9470	1,5	3,3	200	TQO 331125 (LM 869449DGW-410-410D)

Four-row tapered roller bearings

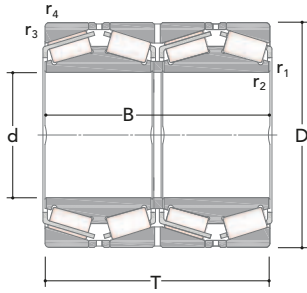

TQO1

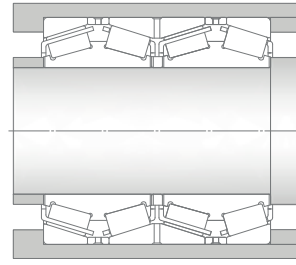

Main dimensions				Basic load ratings		Dimensions		Mass	Designation
d	D	T	B	Dynamic C	Static C ₀	r _{1,2min}	r _{3,4min}		(AFBMA part number)
[mm/in]				[kN]		[mm]		[kg]	-
431,8	571,5	336,55	336,55	4770	13780	1,5	3,3	240	TQO 331226
17	22,5	13,25	13,25						(LM 769349DGW-310-310D)
	635	355,6	355,6	6430	14920	6,4	6,4	385	TQO 332060
	25	14	14						(EE 931070DGW-250-251XD)
	635	355,6	440	6330	14850	6,4	6,4	405	TQO 334019
	25	14	17,3228						
440	580	420	420	5830	17310	4,5	6,7	300	TQO 328829
17,3228	22,8346	16,5354	16,5354						
	650	353,5	353,5	6430	14760	6,4	6,4	410	TQO 332313
	25,5906	13,9173	13,9173						
444,5	571,5	336,55	336,55	4750	14150	1,5	3,3	215	TQO 328670
17,5	22,5	13,25	13,25						
447,675	635	463,55	463,55	8050	21920	3,3	6,4	485	TQO 330608
17,625	25	18,25	18,25						(M 27049DGW-710-710D)
450	580	450	450	5970	19390	3	6	280	TQO 328161
17,7165	22,8346	17,7165	17,7165						
	595	368	368	5380	16110	3	6	285	TQO 332773
	23,4252	14,4882	14,4882						(M 270449DA-410-410D)
	595	404	404	5320	16260	3	6	305	TQO 328365
	23,4252	15,9055	15,9055						(M 270449DA-410)
457,073	730,148	419,1	412,75	8650	19290	1,5	6,4	630	TQO 328287
17,995	28,746	16,5	16,25						(EE 671798DGW-2873-2875D)
457,2	596,9	279,4	276,225	4090	10680	1,5	3,3	200	TQO 331169
18	23,5	11	10,875						(L 770847DW-810-810D)
	596,9	279,4	276,225	4090	10680	1,5	3,3	200	TQO 331169
	23,5	11	10,875						(L 770847DGW-810-810D)
	596,9	320	320	4650	13450	3,3	3,3	235	TQO 334006
	23,5	12,5984	12,5984						
460	610	360	360	5810	16160	3	6	295	TQO 331977
18,1102	24,0157	14,1732	14,173						
	610	400	400	6090	17170	2,5	4	315	TQO 328285
	24,0175	15,748	15,748						
	625	421	421	6970	19740	3	9	382	TQO 332502
	24,6063	16,5748	16,5748						(M 271149DW-110-110D)

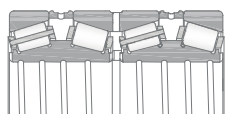

TQO2

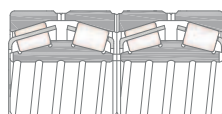

TQO3

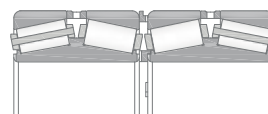

SET2xTDI

Main dimensions				Basic load ratings		Dimensions		Mass	Designation
d	D	T	B	Dynamic C	Static C ₀	r _{1,2min}	r _{3,4min}		(AFBMA part number)
[mm/in]				[kN]		[mm]		[kg]	-
462 18,189	615,95 24,25	330,2 13	330,2 13	5300	14770	3,3	6,4	275	TQO 328692
475 18,7008	600 23,622	368 14,4882	368 14,4882	5170	16430	2	6	250	TQO 328913
	660 25,9843	450 17,7165	450 17,7165	8390	22370	4	6	460	TQO 329007
479,425 18,875	679,45 26,75	495,3 19,5	495,3 19,5	9140	22230	3,3	6,4	605	TQO 330886 (M 272749DGDW-710-710D)
482,6 19	615,95 24,25	330,2 13	330,2 13	5000	15270	6,4	6,4	245	TQO 332096 (LM 272248DGDW-210-210D)
	615,95 24,25	330,2 13	330,2 13	5000	15270	3,3	6,4	245	TQO 330641 (LM 272249DGDW-210-210D)
	615,95 24,25	330,2 13	419,1 16,5	5000	15270	3,5	6,4	265	TQO 331626 (LM 272249DWA-210-210D)
	630 24,8031	420 16,5354	420 16,5354	6460	19080	3,3	6,4	345	TQO 328773
	647,7 25,5	417,512 16,4375	417,512 16,4375	6980	19970	3,3	6,4	400	TQO 331259 (M 272647DGDW-610-610D)
488,95 19,25	622,3 24,5	365,125 14,375	365,125 14,375	5490	17120	3	3	265	TQO 328391
489,026 19,253	634,873 24,995	320,675 12,625	320,675 12,625	4960	14590	3,3	3,3	270	TQO 331090 (EE 243193DGDW-250-251D)
	634,873 24,995	320,675 12,625	320,675 12,625	4960	14590	3,3	3,3	270	TQO 328282 (LM 772749DGDW-710-710D)
500 19,685	720 28,3465	400 15,748	400 15,748	7930	20020	3	6	550	TQO 328524
501,65 19,75	673,1 26,5	387,35 15,25	400,05 15,75	6940	19150	3,3	6,4	395	TQO 331499 (EE 641198DGDW-265-266D)
	711,2 28	520,7 20,5	520,7 20,5	9810	27000	3,3	6,4	755	TQO 331081 (M 274149DGDW-110-110D)
508 20	762 30	463,55 18,25	463,55 18,25	9830	22820	6,4	6,4	730	TQO 332131 (EE 531201DGDW-300-301XD)

Four-row tapered roller bearings

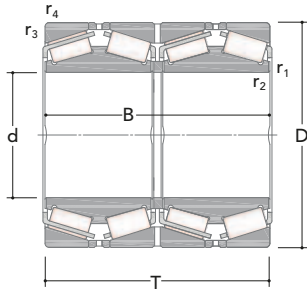

TQO1

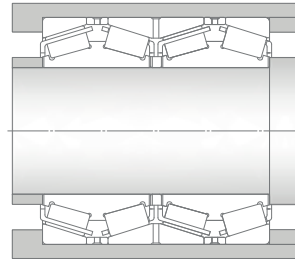

Main dimensions				Basic load ratings		Dimensions		Mass	Designation
d	D	T	B	Dynamic C	Static C ₀	r _{1,2min}	r _{3,4min}		(AFBMA part number)
[mm/in]				[kN]		[mm]		[kg]	-
510 20,0787	655 25,7874	379 14,9213	377 14,8425	6080	18630	1,5	6,4	330	TQO 331747
514,35 20,25	673,1 26,5	422,275 16,625	422,275 16,625	7030	21300	3,3	6,4	410	TQO 331157 (LM 274449DGW-410-410D)
519,112 20,4375	736,6 29	536,575 21,125	536,575 21,125	11100	30520	3,3	6,4	755	TQO 331078 (M 275349DGW-310-310D)
520,7 20,5	711,2 28	400,05 15,75	400,05 15,75	7280	19280	3,3	6,4	460	TQO 331243 (LM 275349DGW-310-310D)
536,575 21,125	761,873 29,995	558,8 22	558,8 22	11280	31510	3,3	6,4	835	TQO 331174 (M 276449DGW-410-410D)
540 21,2598	690 27,1654	400 15,748	400 15,748	5540	16110	3	6	375	TQO 331978
	690 27,1654	400 15,748	434 17,0866	5590	16110	1	5	400	TQO 334038
558,8 22	736,6 29	322,268 12,6877	322,268 12,6876	6110	16500	3,3	6,4	375	TQO 331165 (EE 843221DW-290-291D)
	736,6 29	409,575 16,125	409,575 16,125	7360	21830	3,3	6,4	475	TQO 330993 (LM 377449DGW-410-410D)
	736,6 29	457,2 18	455,612 17,9375	8200	25600	3,3	6,4	545	TQO 331346 (LM 277149DGW-110-110D)
560 22,0472	920 36,2205	618 24,3307	618 24,3307	16020	33690	7,5	7,5	1700	TQO 328509
571,5 22,5	812,8 32	593,725 23,375	593,725 23,375	11750	31410	3,3	6,4	1000	TQO 330529 (M 278749DGW-710-710D)
584,2 23	730,25 28,75	349,25 13,75	342,9 13,5	5370	16790	1,5	3,3	330	TQO 331189
	762 30	401,638 15,8125	396,875 15,625	7460	22070	3,3	6,4	485	TQO 331148 (LM 778549DGW-510-510D)
	901,7 35,5	539,747 21,2499	523,08 20,5937	12950	27630	3,3	9,7	1250	TQO 328314 (EE 665231DGW-355-356D)

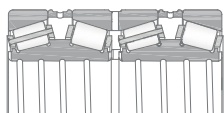
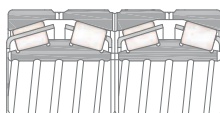
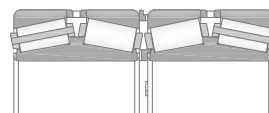

TQO2

TQO3

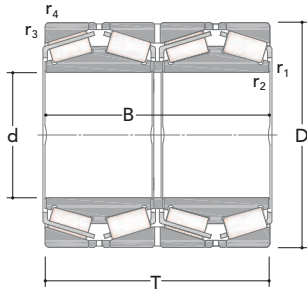
SET2xTDI

Main dimensions				Basic load ratings		Dimensions		Mass	Designation
d	D	T	B	Dynamic C	Static C ₀	r _{1,2min}	r _{3,4min}		(AFBMA part number)
[mm/in]				[kN]		[mm]		[kg]	-
585,788 23,0625	771,525 30,375	479,425 18,875	479,425 18,875	9520	29750	3,3	6,4	625	TQO 331093 (LM 278849DGW-810-810D)
595,312 23,4375	844,55 33,25	615,95 24,25	615,95 24,25	13080	36360	3,3	6,4	1115	TQO 331300 (M 280049DGW-010-010D)
596,9 23,5	980 38,5827	609,6 24	604,838 23,8125	16260	36060	6,4	12,7	1920	TQO 331566
600 23,622	870 34,252	488 19,2126	488 19,2126	12030	28790	3	6	940	TQO 328350
603,25 23,622	857,25 33,75	622,3 24,5	622,3 24,5	14130	40150	3,3	6,4	1235	TQO 331625 (M 280249DGW-210-210XD)
609,6 24	787,4 31	361,95 14,25	361,95 14,25	7180	20870	3,3	6,4	455	TQO 331175 (EE 649241DGW-310-311D)
	813,562	479,425	479,425	10310	29990	3,3	6,4	715	TQO 331925 (LM 280249DGW-210-210D)
	32,03	18,875	18,875	14630	41050	3,3	6,4	1240	TQO 332391 (M 280349DGW-310-310D)
	863,6	660,4	660,4						
	34	26	26						
620 24,4094	800 31,496	363,5 14,311	363,5 14,311	7200	21240	3	6	465	TQO 328510
635 25	901,7 35,5	654,05 25,75	654,05 25,75	15210	44510	3,3	6,4	1420	TQO 330990 (M 281049DGW-010-010D)
646,112 25,4375	857,25 33,75	542,925 21,375	542,925 21,375	11630	35810	3,3	6,4	875	TQO 332671 (LM 281049DGW-310-010D)
650 25,5906	915 36,0236	674 26,5354	674 26,5354	15650	44190	3,3	6,4	1430	TQO 332307 (M 281349DGW-310-310D)
	1030	560	560	15900	3626	15	10	1830	TQO 332827
	40,5512	22,0472	22,0472						
657,225 25,875	933,45 36,75	676,275 26,625	676,275 26,625	16700	48560	3,3	6,4	1575	TQO 330824 (M 281649DGW-610-610D)
660 25,9843	855 33,6614	318,48 12,5386	319,192 12,5666	5930	16870	4,8	9,7	490	TQO 331065 (EE 749259DGW-334-335D)

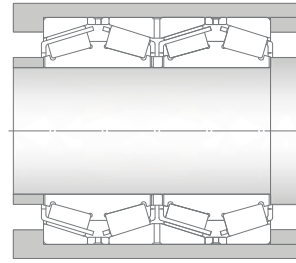
Four-row tapered roller bearings



TQO1

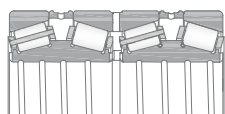
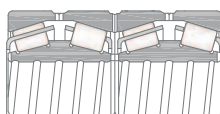
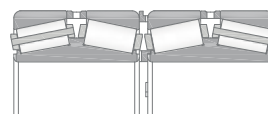

Main dimensions				Basic load ratings		Dimensions		Mass	Designation
d	D	T	B	Dynamic C	Static C ₀	r _{1,2min}	r _{3,4min}		(AFBMA part number)
[mm/in]				[kN]		[mm]		[kg]	-
660 25,9843	855 33,6614	318,5 12,5394	318,5 12,5394	6790	18330	5	7,5	490	TQO 328511
660,4 26	812,8 32	365,125 14,375	365,125 14,375	6530	22030	3,3	6,4	420	TQO 331190 (L 281149DGW-110-110D)
676 26,6142	910 35,8268	620 24,4094	620 24,4094	13840	41290	4	8	1150	TQO 332906
679,45 26,75	901,7 35,5	552,45 21,75	552,45 21,75	11900	36040	3,3	6,4	975	TQO 331700 (LM 281849DGW-810-810D)
	901,7 35,5	552,45 21,75	552,45 21,75	12590	38570	3,3	6,4	975	TQO 331700 (LM 281849DGW-810-810D)
682,625 26,875	965,2 38	701,675 27,625	701,675 27,625	17080	49040	3,3	6,4	1750	TQO 331503 (M 282249DGW-210-210D)
685,8 27	876,3 34,5	355,6 14	352,425 13,875	6950	21650	3,3	6,4	530	TQO 331089 (EE 655271DGW-345-346D)
	876,3 34,5	355,6 14	434,975 17,185	7040	21720	3,3	6,4	580	TQO 328704 (EE 655271DWA-345-346D)
708,025 27,875	930,275 36,625	565,15 22,25	565,15 22,25	12560	38870	3,3	6,4	1030	TQO 332098 LM 282549DGW-510-510D)
710 27,9527	900 35,4331	410 16,1417	410 16,1417	8440	25970	3	6	660	TQO 331351 (L 882449DGW-410-410D)
711,2 28	914,4 36	317,5 12,5	317,5 12,5	6850	19170	3,3	6,4	525	TQO 330882 (EE 755281DGW-360-361D)
714,375 28,125	1016 40	704,85 27,75	704,85 27,75	18040	52720	3,3	6,4	1950	TQO 331358 (M 383240DGW-210-210D)
717,55 28,25	946,15 37,25	565,15 22,25	565,15 22,25	12930	39890	3,3	6,4	1090	TQO 332244 (LM 282847DGW-810-810D)
730 28,7401	940 37,0079	500 19,685	500 19,685	11830	35560	3,5	8	925	TQO 331752

TQO2

TQO3

SET2xTDI

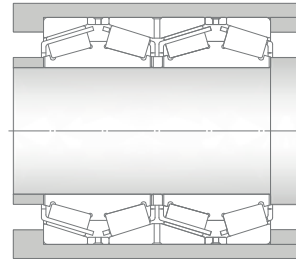
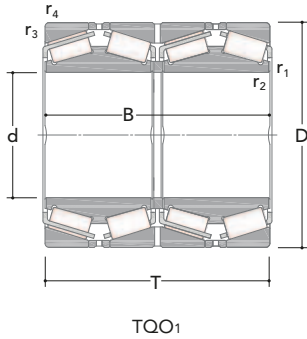
Main dimensions				Basic load ratings		Dimensions		Mass	Designation
d	D	T	B	Dynamic C	Static C ₀	r _{1,2min}	r _{3,4min}		(AFBMA part number)
[mm/in]				[kN]		[mm]		[kg]	-
730,25 28,75	1035,05 40,75	755,65 29,75	755,65 29,75	19800	57690	3,3	6,4	2170	TQO 330803 (M 283449DGW-410-410D)
749,3 29,5	990,6 39	605 23,8189	605 23,8189	14730	44840	3,3	6,4	1250	TQO 331616 (LM 283649DGW-610-610D)
	1066,8 42	736,6 29	723,9 28,5	19850	58420	25,4x20°	12,7	2250	TQO 331094 (EE 325296DGW-420-421XD)
750 29,5276	1130 44,4882	690 27,1654	690 27,1654	19630	46360	4	7,5	2430	TQO 328376
762 30	1066,8 42	736,6 29	723,9 28,5	19890	57950	8	12,7	2145	TQO 331907 (M 284148DGW-111-110D)
	1079,5 42,5	787,4 31	787,4 31	21770	64980	4,8	12,7	2480	TQO 330676 (M 284249DGW-210-210D)
812,8 32	1143 45	768,35 30,25	768,35 30,25	21340	62380	6,4	12,7	2590	TQO 331248
825,5 32,5	1168,4 46	844,55 33,25	844,55 33,25	24960	74970	4,8	12,7	3050	TQO 331066 A/HA4 (M 285848DGW-810-810D)
850 33,4646	1360 53,5433	910 35,8268	910 35,8268	33480	81740	6	12	5440	TQO 331069
863,6 34	1130,3 44,5	669,925 26,375	669,925 26,375	19190	61970	4,8	12,7	1900	TQO 331123 (LM 286249DGW-210-210D)
	1169,987 46,0625	844,55 33,25	844,55 33,25	22970	75360	4,8	12,7	2700	TQO 332967
	1181,1 46,5	666,75 26,25	666,75 26,25	20460	56950	4,8	12,7	2150	TQO 331649 (LM 286449DGW-410-410D)
	1219,2 48	889 35	876,3 34,5	27450	80450	4,8	12,7	3470	TQO 330742 EE 547341DGW-480-481D)
877,888 34,5625	1220 48,0315	844,55 33,25	844,55 33,25	25350	76130	4,8	12,7	3080	TQO 332981 (LM 286749DGW-711)
901,7 35,5	1295,4 51	914,4 36	901,7 35,5	29940	84960	4,8	12,7	4170	TQO 330903 (EE 634356DGW-510-510D)

Four-row tapered roller bearings



Main dimensions				Basic load ratings		Dimensions		Mass	Designation
d	D	T	B	Dynamic C	Static C ₀	r _{1,2min}	r _{3,4min}		(AFBMA part number)
[mm/in]				[kN]		[mm]		[kg]	-
938,213 36,9375	1270 50	825,5 32,5	825,5 32,5	25100	81120	4,8	12,7	3230	TQO 330726 (LM 287649DGW-610-610D)
939,8 37	1333,5 52,5	952,5 37,5	952,5 37,5	30910	93950	4,8	12,7	4510	TQO 330944 (LM 287849DGW-210-210D)
1001 39,4094	1360 53,5433	800 31,4961	800 31,4961	26920	81420	12	12,7	3390	TQO 334031
1003,3 39,5	1358,9 53,5	800,1 31,5	800,1 31,5	26930	80630	4,8	12,7	3450	TQO 331372
1070 42,126	1400 55,118	889,762 35,03	889,762 35,03	29330	99820	4	12	3730	TQO 328100
1080 42,5197	1450 57,0866	950 37,4016	950 37,4016	32790	107000	5	12	4450	TQO 331559
1139,825 44,875	1509,712 59,4375	923,925 36,375	923,9251 36,375	32340	107000	4,8	12,7	4840	TQO 331334
1200,15 47,25	1593,85 62,75	990,6 39	990,6001 39	37070	124000	4,8	12,7	5635	TQO 331440 (LM 288949DGW-910-910D)
1250 49,2126	1550 61,0236	890 35,0394	8901 35,0394	29310	113000	5	12	3820	TQO 328819
1260 49,6063	1640 64,5669	1000 39,3701	10001 39,3701	37860	142000	5	12	5800	TQO 332124
1300 51,1811	1720 67,7165	1040 40,9449	10401 40,9449	41440	139000	5	12	7000	TQO 331950
1370 53,937	1765 69,4882	1050 41,3386	10351 40,748	41540	151000	5	12	6960	TQO 331349
1500 59,0551	1900 74,8031	1080 42,5197	10801 42,5197	44990	166000	4	12	7700	TQO 332078
1580 62,2047	1960 77,1654	1080 42,5197	10801 42,5197	44130	175000	5	12	7800	TQO 331934

Four-row tapered roller bearings

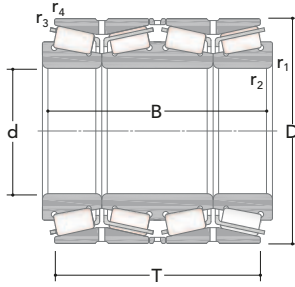

TQI

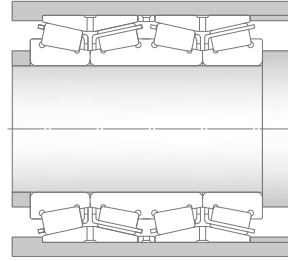

Main dimensions				Basic load ratings		Dimensions		Mass	Designation
d	D	T	B	Dynamic C	Static C ₀	r _{1,2min}	r _{3,4min}		(AFBMA part number)
[mm/in]				[kN]		[mm]		[kg]	-
254 10	358,775 14,125	257,175 10,125	292,1 11,5	2760	7000	3,5	1,5	90,5	TQI 332610 (M 249749-749DW-710D)
279,4 11	407 16,0236	288 11,3386	320 12,5984	3500	8990	3,5	1,5	140	TQI 328345 (M 255449-440DW-411)
317,5 12,5	422,275 16,625	261,938 10,3125	290,514 11,4375	2970	8020	6,5	1,5	110	TQI 332642 (LM 258649T-646TD-649G-610)
333,375 13,125	469,9 18,5	328,612 12,9375	366,712 14,4375	4420	11380	6,4	1,5	190	TQI 328083
347,662 13,6875	469,9 18,5	246,063 9,6875	280,194 11,0313	3240	8230	3,3	1,5	135	TQI 331807
368,3 14,5	523,875 20,625	366,712 14,4375	411,162 16,1875	5690	14800	6,4	1,5	275	TQI 334011
384,175 15,125	546,1 21,5	384,175 15,125	428,625 16,875	6290	16540	6,4	1,5	300	TQI 331809
400 15,748	540 21,2598	295 11,6142	330 12,9921	4690	12380	3,3	1,5	210	TQI 332297
406,4 16	590,55 23,25	381 15	434,975 17,125	6710	16410	9,7	1,5	370	TQI 328923
415,925 16,375	590,55 23,25	419,1 16,5	469,9 18,5	6950	19000	6,4	1,5	405	TQI 332814
431,8 17	571,5 22,5	320,675 12,625	366,713 14,4375	4760	13760	6,4	1,5	250	TQI 331999
	647,7 25,5	338,138 13,3125	387,35 15,25	6400	14840	6,4	1,5	420	TQI 332590
447,675 17,625	635 25	446,088 17,5625	496,888 19,5625	7920	21800	6,4	1,5	475	TQI 328922
450 17,7165	595 23,4252	352 13,8583	390 15,3543	5350	16180	6	1,5	295	TQI 334147

Main dimensions				Basic load ratings		Dimensions		Mass	Designation
d	D	T	B	Dynamic C	Static C ₀	r _{1,2min}	r _{3,4min}		(AFBMA part number)
[mm/in]				[kN]		[mm]		[kg]	-
482,6 19	615,95 24,25	317,5 12,5	355,6 14	5010	15290	6,4	1,5	245	TQI 328268 (M 272249DW-249W-210D)
510 20,0787	655 25,7874	362 14,252	405 15,9449	6040	18880	6,4	1,5	330	TQI 328732

Four-row tapered roller bearings with tapered bore

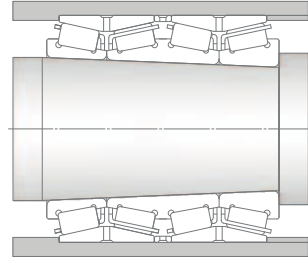
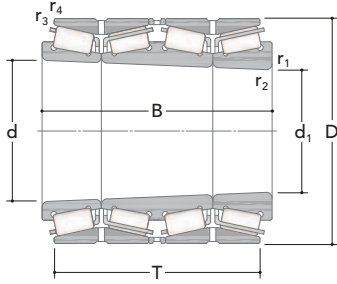

TQIT

Main dimensions					Basic load ratings		Dimensions		Mass	Designation
d	d ₁	D	T	B	Dynamic C	Static C ₀	r _{1,2min}	r _{3,4min}		(AFBMA part number)
[mm/in]					[kN]		[mm]		[kg]	-
170,655 6,7187	156,634 6,1667	225,425 8,875	152,4 6	168,275 6,625	832	2150	3,5	0,8	20,5	TQIT 332646
200,82 7,9063	180,843 7,1198	284,162 11,1875	219,075 8,625	239,715 9,4376	1740	4130	3	1,5	50,5	TQIT 332800 (M 240631T-644TD-647T-611)
258,762 10,1875	234,422 9,2292	358,775 14,125	257,175 10,125	292,1 11,5	2770	7090	3,3	1,5	100	TQIT 332961 (M 249730T-747TD-749T-710)
271,462 10,6875	246,327 9,6944	381 15	269,875 10,625	301,625 11,875	3980	7870	6,4	1,5	80	TQIT 332719 (M 252330T-345TD-349T-310)
287,5 11,3189	259,975 10,2352	440 17,3228	284 11,1811	330,3 13,0039	4050	8400	4	1	180	TQIT 332997
289,833 11,4107	263,333 10,3674	407 16,0236	288 11,3386	375 14,7638	3460	8870	3,5	1,5	125	TQIT 328315
317,5 12,5	294,481 11,5937	438,15 17,25	276,225 10,875	276,225 10,875	3380	8230	1,5	3,3	135	TQOT 328952
320 12,5984	295,833 11,6470	422,275 16,625	261,424 10,2923	290 11,4173	2970	8120	6,5	1,5	120	TQIT 332716 (LM 258630T-646TD-649T-610)
		422,275 16,625	261,424 15,2923	336 13,2283	2970	8120	6	1,5	125	TQITE 328344 (LM 258630T-646TD-649TE-610)
		422,275 16,625	261,424 10,2923	336 13,2283	2970	8120	6,5	1,5	125	TQITE 332962
323,85 12,75	293,952 11,5729	447,675 17,625	323,85 12,75	414,338 16,3125	4250	10770	6	1,5	200	TQIT 332668
345,281 13,5937	315,383 12,4167	488,95 19,25	358,775 14,125	358,775 14,125	4800	12390	3,3	3,3	240	TQOT 334074
352,425 13,875	320,411 12,6146	488,95 19,25	342,9 13,5	384,175 15,125	3720	10190	6,4	1,5	205	TQIT 332654 (HM 262730T-746TD-749T-710)
384,175 15,125	350,838 13,8125	546,1 21,5	400,05 15,75	400,05 15,75	6260	16480	3,3	3,3	340	TQOT 334128

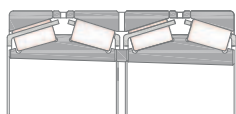
TQOT

Main dimensions					Basic load ratings		Dimensions		Mass	Designation
d	d ₁	D	T	B	Dynamic C	Static C ₀	r _{1,2min}	r _{3,4min}		(AFBMA part number)
[mm/in]					[kN]		[mm]		[kg]	-
390,525 15,375	354,805 13,9687	546,1 21,5	384,175 15,125	428,625 16,875	6300	16420	6,4	1,5	340	TQIT 332664 (HM 266430T-446TD-449T-410)
391,071 15,3965	355,352 13,9902	550 21,6535	384,175 15,125	428,625 16,875	6200	16320	6,4	1,5	345	TQIT 328305 (HM 266432T-445TD-448T-413)
419,1 16,5	379,941 14,9583	590,55 23,25	419,1 16,5	469,9 18,5	7060	19290	6,4	1,5	440	TQIT 328203 (M 268729T-745TD-747T-710)
		590,64 23,2535	419,1 16,5	469,9 18,5	7060	19290	6,4	1,5	440	TQIT 328564 (M 268729T-7457D-747T-710)
453,39 17,85	411,982 16,2198	635 25	446,088 17,5625	496,888 19,5625	8040	21660	6,4	1,5	600	TQIT 332822 (M 270730T-746TD-749T-710)
479,425 18,875	438,150 17,2500	679,45 26,75	495,3 19,5	495,3 19,5	8930	24470	3,3	6,4	645	TQOT 334057
488,95 19,25	444,500 17,5000	679,45 26,75	479,425 18,875	533,4 21	9040	25440	12,7	1,5	640	TQIT 332760 (M 272730T-746TD-749T-710)
515 20,2756	480 18,8976	700 27,5592	420 16,5354	420 16,5354	7700	21220	3	6	515	TQOT 328965
		700 27,5592	370 14,5669	420 16,5354	7080	19220	6	2,5	490	TQIT 334097
530,225 20,875	481,937 18,9739	736,6 29	519,112 20,4375	579,438 22,8125	10810	30540	6,4	1,5	865	TQIT 332933 (M 275330T-346TD-349T-310)
547,688 21,5625	497,683 19,5938	761,873 29,995	536,575 21,125	600,075 23,625	11420	31570	6,4	1,5	930	TQIT 332659 (M 276430T-446TD-449T-410)
555,233 21,8596	497,556 19,5888	761,873 29,995	536,575 21,125	692,15 27,25	11430	31590	6,4	1,5	990	TQITE 334125 (M 276431T-445TD-447TE-410)
571,5 22,5	522,023 20,5523	812,8 32	593,725 23,375	593,725 23,375	12830	35360	3,3	6,4	1105	TQOT 332666
581,025 22,875	527,579 20,7708	812,8 32	571,5 22,5	641,35 25,25	11750	31400	6,4	1,5	1100	TQIT 332658

Four-row tapered roller bearings with tapered bore

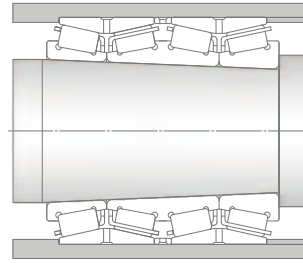
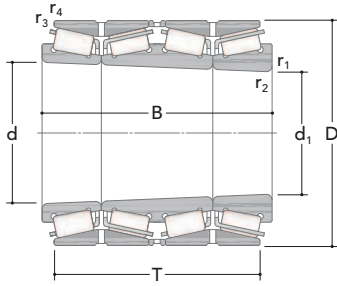

TQIT

Main dimensions					Basic load ratings		Dimensions		Mass	Designation
d	d ₁	D	T	B	Dynamic C	Static C ₀	r _{1,2min}	r _{3,4min}		(AFBMA part number)
[mm/in]					[kN]		[mm]		[kg]	-
604,838 23,8125	569,780 22,4323	787,4 31	369,888 14,5625	420,688 16,5625	8100	22790	6,4	1,5	580	TQIT 328045
644,525 25,375	595,313 23,4375	857,25 33,75	523,875 20,625	590,55 23,25	11800	36340	6,4	1,5	1030	TQIT 332934 (M 281030TL-043TDL-047TL-010)
669,925 26,375	621,667 24,4750	933,45 36,75	649,288 25,5625	725,488 28,5625	16610	48790	6,4	1,5	1700	TQIT 332928 (M 281630T-646TD-649T-610)
680 26,7717	621,667 24,4750	930 36,6142	700 27,5591	700 27,5591	17850	53210	3	6	1625	TQOT 328349
682,625 26,875	624,152 24,5729	965,2 38	701,675 27,625	701,675 27,625	16610	48320	3,3	6,4	1825	TQOT 328558
744,538 29,3125	676,806 26,6459	1035,05 40,75	727,075 28,625	812,8 32	19740	58110	9,7	1,5	2350	TQIT 332943 (M 283430T-446TD-449T-410)
749,3 29,5	676,806 26,6459	990,6 39	577 22,7165	650 25,5905	14790	45030	6,4	3,3	1500	TQIT 332596
770 30,315	709,167 27,9200	1040 40,9449	650 25,5906	800 31,496	17900	52920	3	3	2015	TQITE 334099
777,672 30,617	707,294 27,8462	1079,5 42,5	755,65 29,75	844,55 33,25	21260	62150	9,7	3,3	2650	TQIT 332959 (M 284229T-244TD-248T-210)
777,875 30,625	707,457 27,8542	1079,5 42,5	755,65 29,75	844,55 33,25	21490	62170	9,7	3,3	2650	TQIT 332956 (M 284230T-246TD-249T-210)
825,5 32,5	755,121 29,7292	1168,4 46	844,6 33,25	844,6 33,25	22730	75210	4,8	12,7	2800	TQOT 334040
828,675 32,625	759,883 29,9167	1143 45	733,425 28,875	825,5 32,5	21900	65340	9,7	3,3	2475	TQIT 332663
863,6 34	803,853 31,6236	1130,3 44,5	644,525 25,375	717,55 28,25	19180	61910	9,7	3,3	2100	TQIT 332571
	807,773 31,8021	1130,3 44,5	669,925 26,375	669,925 26,375	19230	60830	4,8	12,7	2000	TQOT 328857

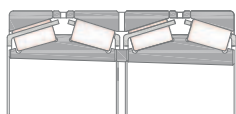
TQOT

Main dimensions					Basic load ratings		Dimensions		Mass	Designation
d	d ₁	D	T	B	Dynamic C	Static C ₀	r _{1,2min}	r _{3,4min}		(AFBMA part number)
[mm/in]					[kN]		[mm]		[kg]	-
872,769	813,239	1179,805	628,65	793,75	20060	55870	9,7	3,3	2530	TQITE 332960
34,361	32,0173	46,449	24,75	31,25						(LM 286433T-443TD-447TE-412)
		1181,1	628,65	714,375	20310	55960	9,7	3,3	2450	TQIT 332786
		46,5	24,75	28,125						(LM 286433T-443TD-447T-410)
872,997	813,466	1181,1	628,65	714,375	20230	56310	9,7	3,3	2450	TQIT 328956
34,3641	32,0262	46,5	24,75	28,125						(LM 286432T-446TD-449T-410)
879,475	801,688	1219,2	838,2	933,45	27000	80760	12,7	3,3	3680	TQIT 328074
34,625	31,5625	48	33	36,75						
889	815,667	1219,2	784,225	880	26410	77850	9,7	3,3	3340	TQIT 332602
35	32,1129	48	30,875	34,6457						
896,903	833,070	1264	680	766	22230	62790	12,7	3,3	3100	TQIT 334081
35,3111	32,7980	49,7638	26,7717	30,1575						
1004,634	936,901	1308,1	730,25	812,8	23950	76010	12,7	3,3	3060	TQIT 332720
39,5525	36,8859	51,5	28,75	32						(LM 288130T-146TD-149T-110)

Four-row tapered roller bearings

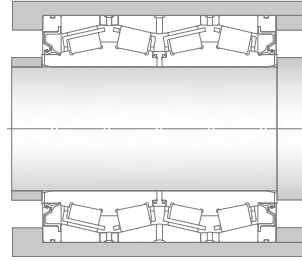
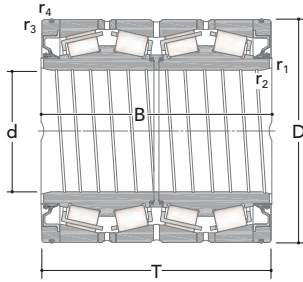

TQOS1

Main dimensions				Basic load ratings		Dimensions		Mass	Designation
d	D	T	B	Dynamic C	Static C ₀	r _{1,2min}	r _{3,4min}		(AFBMA part number)
[mm/in]				[kN]		[mm]		[kg]	-
152,4 6	244,475 9,625	187,325 7,375	192,088 7,5625	1260	2140	1	3,3	30	TQOS 329121
203,2 8	317,5 12,5	266,7 10,5	266,7 10,5	2390	4820	2,5	3,3	76	TQOS 329123
206,375 8,125	282,575 11,125	226 8,8976	226 8,8976	1260	3330	0,6	3,3	40	TQOS 329090
220 8,6614	295 11,6142	315 12,4016	315 12,4016	1460	4040	0,6	2,5	55	TQOS 328853
220,662 8,6875	314,325 12,375	239,712 9,4375	239,712 9,4375	1730	3790	1,5	3,3	56	TQOS 328546
228,6 9	400,05 15,75	296,875 11,688	296,875 11,688	3280	5620	2,5	3,3	148	TQOS 328918
240 9,4488	338 13,3071	340 13,3858	340 13,3858	2300	5490	1,5	4	88	TQOS 328854
241,478 9,507	349,148 13,746	228,6 9	228,6 9	1850	3590	1,5	3,3	64	TQOS 328668
254 10	358,775 14,125	269,875 10,625	269,875 10,625	2240	5300	1,5	3,3	84	TQOS 329071
260 10,2362	365 14,3701	340 13,3858	340 13,3858	3020	7950	2,5	3,5	112	TQOS 329093
266,7 10,5	355,6 14	228,6 9	230,188 9,0625	1680	4090	1,5	3,3	68	TQOS 328468
	355,6 14	228,6 9	230,188 9,0625	1790	4560	1,5	3,3	60	TQOS 328916
276,225 10,875	393,7 15,5	269,875 10,625	269,875 10,625	2660	5840	1	6,4	96	TQOS 328920
	393,7 15,5	269,875 10,625	269,875 10,625	2630	5430	1	6,4	96	TQOS 328554

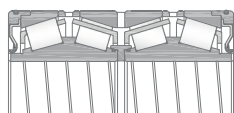

TQOS₂

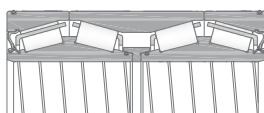

TQOS₃

Main dimensions				Basic load ratings		Dimensions		Mass	Designation (AFBMA part number)
d	D	T	B	Dynamic C	Static C ₀	r _{1,2min}	r _{3,4min}		
[mm/in]				[kN]		[mm]		[kg]	-
279,4 11	393,7 15,5	269,875 10,625	269,875 10,625	2690	5780	1	6,4	96	TQOS 328917
280 11,0236	395 15,5512	340 13,3858	340 13,3858	3490	8530	2,5	3,5	128	TQOS 329092
285,75 11,25	380,898 14,996	244,475 9,625	244,475 9,625	2120	5420	1	3,3	74	TQOS 328878
300 11,811	440 17,3228	279,4 11	280,99 11,0625	3000	6680	3,3	4,8	137	TQOS 334126
304,648 11,994	438,048 17,246	279,4 11	280,99 11,0625	2970	6670	2	4,8	129	TQOS 334008
304,8 12	419,1 16,5	269,875 10,625	269,875 10,625	2770	6810	1	6,4	108	TQOS 329067
	501,65 19,75	336,55 13,25	336,55 13,25	4590	9210	2	6,4	254	TQOS 328909
304,902 12,004	412,648 16,246	266,7 10,5	266,7 10,5	2410	6040	1	3,3	98	TQOS 328278
	412,648 16,246	266,7 10,5	266,7 10,5	2590	6650	1	3,3	100	TQOS 328945
305 12,0079	438,048 17,246	279,4 11	280,99 11,059	2980	6610	2	4,8	129	TQOS 334076
317,5 12,5	422,275 16,625	269,875 10,625	269,875 10,625	2540	6440	1,5	3,3	98	TQOS 334023
333,375 13,125	469,9 18,5	342,9 13,5	342,9 13,5	4150	10280	2,5	3,3	182	TQOS 328921
343,052 13,506	457,098 17,996	254 10	254 10	2620	6290	1	3,3	109	TQOS 328817
	457,098 17,996	254 10	254 10	2410	5980	1	3,3	109	TQOS 334033
	457,098 17,996	254 10	254 10	2280	5990	1	3,3	109	TQOS 334106

Four-row tapered roller bearings

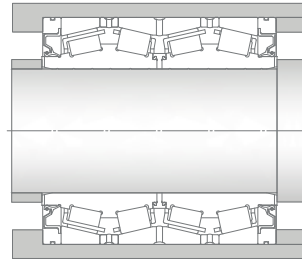
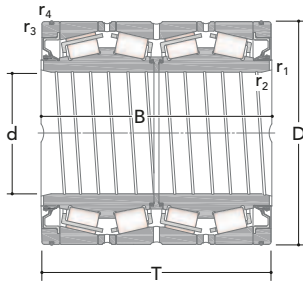

TQOS1

Main dimensions				Basic load ratings		Dimensions		Mass	Designation
d	D	T	B	Dynamic C	Static C ₀	r _{1,2min}	r _{3,4min}		(AFBMA part number)
[mm/in]				[kN]		[mm]		[kg]	-
343,052 13,506	457,098 17,996	254 10	323,85 12,75	2640	6390	1	3,3	120	TQOS 328986
355,6 14	482,6 19	269,875 10,625	265,112 10,4375	3010	7490	1,5	3,3	136	TQOS 328870
	488,95 19,25	317,5 12,5	317,5 12,5	3960	9900	1	3,3	172	TQOS 328912
385,762 15,1875	514,35 20,25	317,5 12,5	317,5 12,5	3760	9940	1	3,3	174	TQOS 334042
406,4 16	546,1 21,5	288,925 11,375	288,925 11,375	3760	9420	1,5	6,4	183	TQOS 328838
	546,1 21,5	330 12,9921	330 12,9921	3880	10160	1,5	6,4	202	TQOS 334093
409,575 16,125	546,1 21,5	334,962 13,1875	334,962 13,1875	4410	11840	1	6,4	210	TQOS 329004
415,925 16,375	590,55 23,25	434,975 17,125	434,975 17,125	6760	17840	3,3	6,4	379	TQOS 328893
416 16,378	574 22,5984	440 17,3228	440 17,3228	5800	16830	2,5	5	341	TQOS 334130
430 16,9291	575 22,6378	380 14,9606	380 14,9606	5080	14200	1,5	5	267	TQOS 334095
440 17,3228	590 23,2283	480 18,8976	480 18,8976	6820	19190	1	5	371	TQOS 334055
	650 25,5906	353,5 13,9173	353,5 13,9173	5960	13040	5,5	6,4	378	TQOS 328944
450 17,7165	595 23,4252	398 15,6693	398 15,6693	5300	16200	2	6	301	TQOS 328846
457,2 18	596,9 23,5	279,4 11	276,225 10,875	3830	9970	1,5	3,3	191	TQOS 328827
460 18,1102	610 24,0157	360 14,1732	360 14,1732	4940	12720	3	6	270	TQOS 328727

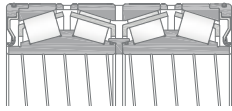

TQOS₂

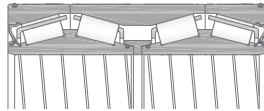

TQOS₃

Main dimensions				Basic load ratings		Dimensions		Mass	Designation (AFBMA part number)
d	D	T	B	Dynamic C	Static C ₀	r _{1,2min}	r _{3,4min}		
[mm/in]				[kN]		[mm]		[kg]	-
475 18,7008	600 23,622	368 14,4882	368 14,4882	4540	13880	2	6	235	TQOS 334078
479,425 18,875	679,45 26,75	495,3 19,5	495,3 19,5	8360	2200	3,3	6,4	565	TQOS 334116
482,6 19	615,95 24,25	330,2 13	330,2 13	4830	13510	1	6,4	232	TQOS 328842
	615,95 24,25	330,2 13	406,4 16	4800	13560	1	6,4	250	TQOS 328887
	615,95 24,25	330,2 13	406,4 16	4330	11990	1	6,4	237	TQOS 328223
	615,95 24,25	330,2 13	419,1 16,5	4840	13690	1	6,4	243	TQOS 334072
	615,95 24,25	402,05 15,8465	402,05 15,8465	5390	16980	1	6,4	290	TQOS 328974
	630 24,8031	420 16,5354	420 16,5354	5700	16670	3,3	6,4	325	TQOS 328930
489,026 19,253	634,873 24,995	320,675 12,625	320,675 12,625	4680	12350	1	3,3	248	TQOS 334014
	634,873 24,995	320,675 12,625	320,675 12,625	3870	11010	1	3,3	247	TQOS 334115
510 20,0787	655 25,7874	379 14,9216	377 14,8425	5560	16180	1,5	6,4	311	TQOS 334022
540 21,2598	690 27,1654	434 17,0866	434 17,0866	6870	20920	2	5	392	TQOS 334028
558,8 22	736,6 29	322,262 12,6875	322,262 12,6875	5610	14200	1,5	6,4	343	TQOS 328864
	736,6 29	409,575 16,125	409,575 16,125	6410	19620	3,3	6,4	475	TQOS 334080
	736,6 29	457,2 18	455,612 17,9375	7600	22970	3,3	6,4	515	TQOS 334136
571,5 22,5	812,8 32	593,725 23,375	593,725 23,375	11460	32950	3,3	6,4	998	TQOS 334144

Four-row tapered roller bearings

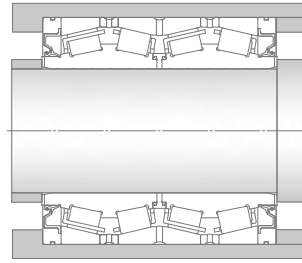
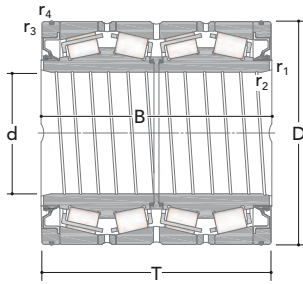

TQOS1

Main dimensions				Basic load ratings		Dimensions		Mass	Designation
d	D	T	B	Dynamic C	Static C ₀	r _{1,2min}	r _{3,4min}		(AFBMA part number)
[mm/in]				[kN]		[mm]		[kg]	-
585,788 23,0625	771,525 30,375	479,425 18,875	479,425 18,875	9140	26950	4	6,4	596	TQOS 328888
609,6 24	787,4 31	361,95 14,25	361,95 14,25	6550	18420	3,3	6,4	430	TQOS 328871
	813,562 32,03	479,425 18,875	479,425 18,875	9330	27070	3,3	6,4	693	TQOS 334108
635 25	901,7 35,5	654,05 25,75	654,05 25,75	13970	41250	3,3	6,4	1354	TQOS 334141
660 25,9843	855 33,6614	318,48 12,5385	400,842 15,7812	6110	17220	4	5	488	TQOS 334002
660,4 26	812,8 32	365,125 14,375	385,424 15,1745	6420	20270	2	6,4	396	TQOS 328977
679,45 26,75	901,7 35,5	552,45 21,75	552,45 21,75	11670	35820	3,3	6,4	975	TQOS 334015
	901,7 35,5	552,45 21,75	635 25	11670	35820	3,3	6,4	1030	TQOS 334016
682,625 26,875	965,2 38	701,675 27,625	701,675 27,625	16580	48710	3,3	6,4	651	TQOS 334060
685,8 27	876,3 34,5	355,6 14	352,425 13,875	7050	19760	3,3	6,4	506	TQOS 328955
710 27,9528	900 35,4331	410 16,1417	410 16,1417	7920	23530	3	6	602	TQOS 334051
711,2 28	914,4 36	317,5 12,5	317,5 125000	6450	17250	2,5	6,4	490	TQOS 329010
	914,4 36	387,35 15,25	425,45 16,75	6870	19230	5,5	3,3	602	TQOS 328988
749,3 29,5	990,6 39	605 23,8189	605 23,8189	12810	40120	3,3	6,4	1274	TQOS 334082
762 30	1079,5 42,5	787,4 31	784,4 31	20560	60390	4,8	12,7	2248	TQOS 334075

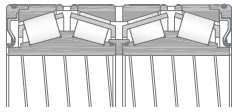

TQOS2

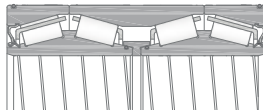

TQOS3

Main dimensions				Basic load ratings		Dimensions		Mass	Designation (AFBMA part number)
d	D	T	B	Dynamic C	Static C ₀	r _{1,2min}	r _{3,4min}		
[mm/in]				[kN]		[mm]		[kg]	-
825,5 32,5	1168,4 46	844,55 33,25	844,55 33,25	23850	73480	4,8	12,7	2958	TQOS 334135
863,6 34	1169,987 46,0625	844,55 33,25	844,55 33,25	22460	69870	4,8	12,7	2630	TQOS 334150



Spherical roller bearings

Spherical roller bearings	245
SRB: a complete range	245
Tailor made solutions	245
Internal clearance	245
Misalignment	246
Minimum load	246
Designs and variants	249
Type CA/CAF	249
Type MA	249
Type ECA	249
Type MB	249
Type CC	250
Special designs and variants	250
Sealed type	250
Type WOR	250
Type ECCS	250
Type ROVSX	251
Split type SSRB	251
Suffixes	252
Prefixes	253
Product tables	255

Spherical roller bearings

The spherical roller bearings (SRBs) manufactured by RKB are engineered to withstand high radial forces and moderate axial forces acting in both directions. RKB SRBs can dynamically accommodate misalignments due to shaft bending. They are produced with cylindrical or tapered bore, in open or sealed execution. Depending on application requirements, RKB Bainite Hardening Treatment (HB) and High Temperature Dimensional Stabilization (S) can be applied on bearing rings and rollers. Moreover, as for dimensions, RKB spherical roller bearings are manufactured according to ISO/ABMA/GOST specifications. As a consequence, they are fully interchangeable with all the bearings that meet the relevant international standards.



SRB: a complete range

The range of RKB spherical roller bearings covers most requirements of standard and special industrial applications, in severe and critical working conditions. RKB offers a wide portfolio of open and sealed SRBs in all diameter and width series. While the narrow low-section bearings (e.g. 238 series) feature

high speed capabilities as well as low weight and minimum space dimensions, the wide high-section bearings (e.g. 233 series) have higher load carrying capacities. All RKB SRBs put together experience in design with proven performance in all major industries.

Tailor made solutions

Besides the main spherical roller bearing designs, RKB has developed new solutions according to specific application requirements. The special designs include SEALED SRBs, for smooth operation in contaminated environments, ROVSX type, expressly designed for vibratory equipment, WOR execution, suitable for gear output shaft of truck concrete mixers, and SPLIT bearings to make maintenance operations easier at hard-to-reach positions. If duly applied, these special designs are cost effective for the customer, since they allow increased bearing life expectancy and reduced machine downtime.

Internal clearance

Spherical roller bearings are produced as standard with Normal radial internal clearance CN, but they are also available with C2, C3, C4 and C5 radial internal clearance, in accordance with the ISO 5753:2009.

Spherical roller bearings for vibratory applications are produced as standard with C4 radial clearance.

The radial internal clearances are reported for bearing with:

- cylindrical bore in the **Tab. 2 page 247**;
- tapered bore in the **Tab. 3 page 248**;

and they are valid only for bearing unmounted and unloaded.

Misalignment

The internal design of the spherical roller bearings can accommodate some misalignment between inner ring and outer ring without affecting negatively the bearing life. If the misalignment is constant respect the outer ring and if the condition are relatively safety ($C/P > 10$) the misalignments reported onto the table are valid, however, depending on the configuration and the working conditions, the values given on the **Tab. 1** have to be properly reduced. In presence of the sealed bearing or in application where the misalignment is not constant like:

- vibration screens where the load is rotating on the outer ring and fixed on the inner ring (eccentric masses) that generates a bending on the shaft;
- deflection - compensation rolls of paper machines where the stationary shaft is bent.

it is suggested do not exceed a few tenths of degree, since the rolling element may be affected by possible sliding movements. Consequently, due to the friction between rolling elements and raceways, an increasing of temperature will be generated.

For the sealed versions, in order to guarantee the efficiency of the seals, a permissible misalignment value of approximatively 0.5° between inner ring and outer ring has to be considered.

Minimum load

A minimum radial load is requested for a spherical roller bearings, like for all ball and roller bearings, in order to operate correctly an adequate operation condition, especially in critical working conditions: high speed, high acceleration and sudden changes of rotating direction. In these operating conditions a skidding between rollers and raceways can be generated by the inertial forces, influencing negatively the bearing life. Minimum radial load can be estimated using the following formula:

$$\frac{F_{rm}}{C_r} > 0,023$$

Where:

- F_{rm} minimum radial load, [kN];
- C_r basic dynamic radial load, [kN].

Bearing series	Maximum misalignment for $P < 0.1 \cdot C_r$
238	$\pm 1^\circ$
213, 222, 230, 239, 240, 248, 249	$\pm 1.5^\circ$
223, 231, 232, 233, 241	$\pm 2^\circ$

Tab. 1 - SRBs max permissible angular misalignment

Spherical roller bearings

d [mm]		Radial internal clearance [μm]							
		C2		CN		C3		C4	
over	incl.	min.	max.	min.	max.	min.	max.	min.	max.
14	18	10	20	20	35	35	45	45	60
18	24	10	20	20	35	35	45	45	60
24	30	15	25	25	40	40	55	55	75
30	40	15	30	30	45	45	60	60	80
40	50	20	35	35	55	55	75	75	100
50	65	20	40	40	65	65	90	90	120
65	80	30	50	50	80	80	110	110	145
80	100	35	60	60	100	100	135	135	180
100	120	40	75	75	120	120	160	160	210
120	140	50	95	95	145	145	190	190	240
140	160	60	110	110	170	170	220	220	280
160	180	65	120	120	180	180	240	240	310
180	200	70	130	130	200	200	260	260	340
200	225	80	140	140	220	220	290	290	380
225	250	90	150	150	240	240	320	320	420
250	280	100	170	170	260	260	350	350	460
280	315	110	190	190	280	280	370	370	500
315	355	120	200	200	310	310	410	410	550
355	400	130	220	220	340	340	450	450	600
400	450	140	240	240	370	370	500	500	660
450	500	140	260	260	410	410	550	550	720
500	560	150	280	280	440	440	600	600	780
560	630	170	310	310	480	480	650	650	850
630	710	190	350	350	530	530	700	700	920
710	800	210	390	390	580	580	770	770	1 010
800	900	230	430	430	650	650	860	860	1 120
900	1 000	260	480	480	710	710	930	930	1 220
1 000	1 120	290	530	530	770	770	1 050	1 050	1 430
1 120	1 250	320	580	580	840	840	1 140	1 140	1 560
1 250	1 400	350	630	630	910	910	1 240	1 240	1 700
1 400	1 600	380	700	700	1 020	1 020	1 390	1 390	1 890
1 600	1 800	420	780	780	1 140	1 140	1 550	1 550	2 090
1 800	2 000	460	860	860	1 260	1 260	1 710	1 710	2 300
2 000	2 250	500	950	950	1 400	1 400	1 900	1 900	2 540
2 250	2 500	550	1 050	1 050	1 550	1 550	2 100	2 100	2 790

Tab. 2 - Radial internal clearance of spherical roller bearings with cylindrical bore

d [mm]		Radial internal clearance [μm]							
		C2		CN		C3		C4	
over	incl.	min.	max.	min.	max.	min.	max.	min.	max.
18	24	15	25	25	35	35	45	45	60
24	30	20	30	30	40	40	55	55	75
30	40	25	35	35	50	50	65	65	85
40	50	30	45	45	60	60	80	80	100
50	65	40	55	55	75	75	95	95	120
65	80	50	70	70	95	95	120	120	150
80	100	55	80	80	110	110	140	140	180
100	120	65	100	100	135	135	170	170	220
120	140	80	120	120	160	160	200	200	260
140	160	90	130	130	180	180	230	230	300
160	180	100	140	140	200	200	260	260	340
180	200	110	160	160	220	220	290	290	370
200	225	120	180	180	250	250	320	320	410
225	250	140	200	200	270	270	350	350	450
250	280	150	220	220	300	300	390	390	490
280	315	170	240	240	330	330	430	430	540
315	355	190	270	270	360	360	470	470	590
355	400	210	300	300	400	400	520	520	650
400	450	230	330	330	440	440	570	570	720
450	500	260	370	370	490	490	630	630	790
500	560	290	410	410	540	540	680	680	870
560	630	320	460	460	600	600	760	760	980
630	710	350	510	510	670	670	850	850	1 090
710	800	390	570	570	750	750	960	960	1 220
800	900	440	640	640	840	840	1 070	1 070	1 370
900	1 000	490	710	710	930	930	1 190	1 190	1 520
1 000	1 120	540	780	780	1 020	1 020	1 300	1 300	1 650
1 120	1 250	600	860	860	1 120	1 120	1 420	1 420	1 800
1 250	1 400	660	940	940	1 220	1 220	1 550	1 550	1 960
1 400	1 600	740	1 060	1 060	1 380	1 380	1 750	1 750	2 200
1 600	1 800	820	1 180	1 180	1 540	1 540	1 950	1 950	2 500
1 800	2 000	910	1 310	1 310	1 710	1 710	2 150	2 150	2 750
2 000	2 250	1 000	1 450	1 450	1 900	1 900	2 400	2 400	3 050
2 250	2 500	1 100	1 600	1 600	2 100	2 100	2 650	2 650	3 350

Tab. 3 - Radial internal clearance of spherical roller bearings with tapered bore

Spherical roller bearings

Designs and variants

Type CA/CAF

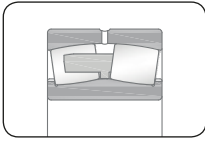

- Design used for large size bearings, withstanding high radial loads and moderate axial loads in both directions
- Inner ring with integral side ribs
- Symmetrical roller profile
- One-piece double pronged machined brass or steel (CAF) cage with integral slinger guided on the inner ring
- Lubrication groove and holes in the outer ring
- Available with lubrication groove and three lubrication holes in the outer ring and six lubrication holes in the inner ring (W513)

Type MA

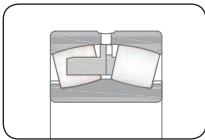

- Design used for medium and large size bearings
- Inner ring with integral side ribs
- Symmetrical roller profile
- Two-piece machined brass cage guided on the outer ring
- Lubrication groove and holes in the outer ring
- Optimized separable cage for better performance in case of different rolling element speed
- Available with lubrication groove and three lubrication holes in the outer ring and six lubrication holes in the inner ring (W513)

Type ECA

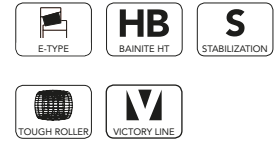
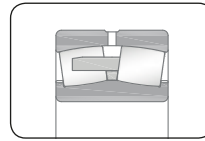

- Design used for large size bearings, based on CA design, with optimized roller set
- Inner ring with integral side ribs
- Symmetrical roller profile
- One-piece double pronged machined brass cage with separated slinger guided on the inner ring
- Lubrication groove and holes in the outer ring
- Available with lubrication groove and three lubrication holes in the outer ring and six lubrication holes in the inner ring (W513)

Type MB

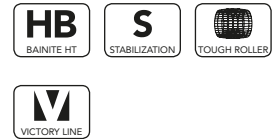
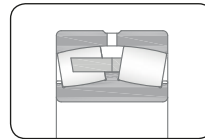

- Design used for medium size bearings operating at medium to high speeds, featuring high load carrying capacities
- Inner ring with integral side and central ribs
- Symmetrical or asymmetrical roller profile
- Two-piece machined brass cage guided on the inner ring
- Lubrication groove and holes in the outer ring
- Available with lubrication groove and three lubrication holes in the outer ring and six lubrication holes in the inner ring (W513)

Type CC

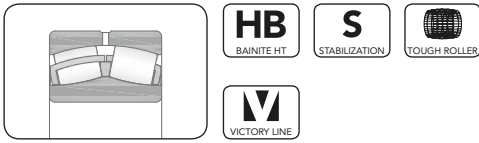

- Design used for medium size bearings operating at medium to high speeds and featuring high load carrying capacities
- Ribless inner ring
- Symmetrical or asymmetrical roller profile
- Two-piece window type pressed steel cage guided on the inner ring
- Lubrication groove and holes in the outer ring
- Available with lubrication groove and three lubrication holes in the outer ring and six lubrication holes in the inner ring (W513)

Type WOR

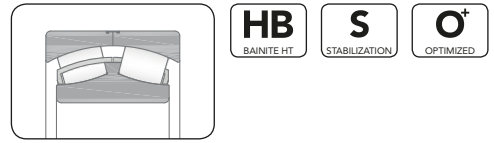

- Design used for gear output shaft of truck concrete mixers
- Inner ring with integral central rib
- Symmetrical or asymmetrical roller profile
- Two-piece pressed steel window type cage guided on the inner ring
- Wider outer ring (WOR) in one piece or split into two halves
- Permissible misalignment greater than standard execution
- Available with two-piece machined brass cage guided on the inner ring

Special designs and variants

Sealed type



- Design used for medium and large size bearings operating at medium speeds
- Inner ring with integral side ribs
- Symmetrical roller profile
- One-piece double pronged machined brass cage with integral slinger guided on the inner ring
- Integral rubber seals on both bearing sides for harsh working conditions (2CZ)
- Lubrication groove and holes in the outer ring
- Available with plugged lubrication holes in the outer ring (W77)
- Available with two-piece window type pressed steel cage guided on the inner ring

Type ECCS



- Design used for small to medium size bearings
- Ribless inner ring
- Symmetrical roller profile
- Two-piece pressed steel window type cage with slotted open face to improve lubricant flow and separated slinger guided on the inner ring
- Lubrication groove and six holes in the outer ring (W33X)
- Suitable for harsh environments
- Available with lubrication groove, three lubrication holes in the outer ring and six lubrication holes in the inner ring (W513)

Spherical roller bearings

Type ROVSX

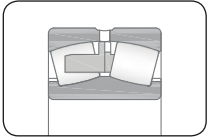

- Design used for vibratory equipment
- Inner ring with integral side ribs
- Symmetrical roller profile
- Two-piece machined brass cage guided on the outer ring
- Radial internal clearance higher than normal CN
- Running accuracy higher than standard execution
- Available with lubrication groove, three lubrication holes in the outer ring and six lubrication holes in the inner ring (W513)

Split type SSRB

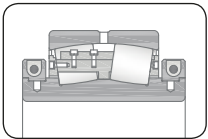

- Design used for medium and large size bearings
- Wider inner ring with integral side ribs
- Symmetrical roller profile
- Two-piece bolted double pronged machined brass cage guided on the inner ring
- Engineered for hard-to-reach positions (e.g. bucket wheel excavators)
- Design for easy mounting, dismounting and maintenance to reduced machine downtime
- Available in taylor-made dimension

Suffixes	Internal design
WOR	Wider outer ring. The value immediately following the WOR gives the width of the outer ring in mm
ROVS/ROVSX	Bearing for vibratory equipment
ID	Special inner diameter. The value immediately following the ID gives the inner diameter in mm
E	Optimized internal design for increased load ratings
SP	Special or non-standard bearing

Suffixes	Cage and design
M	Machined brass cage guided on rollers
MA	Machined brass cage guided on outer ring
MB	Machined brass cage guided on inner ring
CA	Double pronged machined brass cage
CAF	Double pronged machined steel cage
CC	Pressed steel cage
CCS	Pressed steel cage and axial lubrication grooves

Suffixes	Accuracy, clearance, running
ST	Special tolerance

Suffixes	Lubrication
W33	Annular groove and three lubrication holes in outer ring
W33X	Annular groove and more than three lubrication holes in outer ring
W513	W33 + six lubrication holes in inner ring
W513B	W33 + annular groove and six lubrication holes in inner ring
W513BX	W33X + annular groove and six lubrication holes in inner ring
W77	Annular groove and plugged lubrication holes in outer ring
W77X	Annular groove and more than three plugged lubrication holes in outer ring
W20	Three lubrication holes in the outer ring

Suffixes	Lubrication
G/R3	Filled with exceptionally good low noise profile and long life grease usable over a wide range of temperatures
G/R4	Filled with good low noise profile and high temperature, high speed and long life grease
C7A	Annular groove, seven lubrication holes and one blind counterbored hole in outer ring

Spherical roller bearings

Suffixes	External design
2CZ	Bearing with FKM seal on both sides and filled with EP lithium base grease
2CS	Bearing with FKM seal on both sides and filled with EP lithium base grease (BS2 series)
ZZ or 2Z	Shield on both sides
K	Tapered bore, taper 1:12
K30	Tapered bore, taper
N1	One locating slot in outer ring
N2I	Two slots in inner ring
N4I	Four slots in inner ring

Prefixes	Alternative designation
BS2	Spherical roller bearing followed by size indication
SRB	Out of standard spherical roller bearing followed by drawing number
SSRB	Out of standard split spherical roller bearing followed by drawing number

Spherical roller bearings

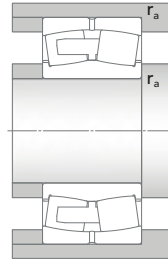
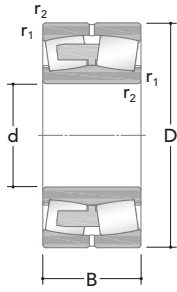

CA/CAF

Main dimensions			Basic load ratings		Speed ratings		Dimensions		Mass	Designation	
d	D	B	Dynamic C	Static C ₀	Reference	Limiting	r _{1,2min}	r _{amax}		Cylindrical bore	Tapered bore
[mm]			[kN]		[rpm]		[mm]		[Kg]	-	
25	52	18	47,8	43,8	12600	14100	1	1	0,26	22205	22205 K
	62	17	46,2	41,2	8900	9900	1,1	1	0,28	21305	-
30	62	20	62,3	59,6	9700	11600	1	1	0,29	22206	22206 K
	72	19	62,5	60,8	8000	8400	1,1	1	0,41	21306	21306 K
35	72	23	83,1	83,4	8600	10200	1,1	1	0,45	22207	22207 K
	80	21	73,8	70,9	7000	7800	1,5	1,5	0,55	21307	21307 K
40	80	23	93,6	88,2	7700	9000	1,1	1	0,53	22208	22208 K
	90	23	101	108	6700	8000	1,5	1,5	0,75	21308	21308 K
	90	33	147	140	5800	6900	1,5	1,5	1,05	22308	22308 K
45	85	23	99,8	97,9	7300	8400	1,1	1	0,58	22209	22209 K
	100	25	121	125	6000	7200	1,5	1,5	0,99	21309	21309 K
	100	36	177	183	5100	5700	1,5	1,5	1,4	22309	22309 K
50	90	23	100	107	6700	8100	1,1	1	0,63	22210	22210 K
	110	27	151	163	5400	6200	2	2	1,35	21310	21310 K
	110	40	215	224	4700	5400	2	2	1,9	22310	22310 K
55	100	25	122	127	6100	7100	1,5	1,5	0,84	22211	22211 K
	120	29	150	163	5300	6300	2	2	1,7	21311	21311 K
	120	43	264	279	4200	4600	2	2	2,45	22311	22311 K
60	110	28	153	164	5400	6200	1,5	1,5	1,15	22212	22212 K
	130	31	207	239	4600	5200	2,1	2	2,1	21312	21312 K
	130	46	300	330	3800	4500	2,1	2	3,1	22312	22312 K
65	100	35	129	172	4100	5300	1,1	1	0,95	24013	24013 K30
	120	31	189	213	4800	5700	1,5	1,5	1,55	22213	22213 K
	140	33	228	267	4100	5000	2,1	2	2,55	21313	21313 K
	140	48	330	353	3600	4300	2,1	2	3,75	22313	22313 K
70	125	31	200	226	4800	5600	1,5	1,5	1,55	22214	22214 K
	150	35	279	321	3900	4800	2,1	2	3,1	21314	21314 K
	150	51	389	427	3300	3800	2,1	2	4,55	22314	22314 K
75	115	40	169	229	3700	4400	1,1	1	1,55	24015	24015 K30
	130	31	208	240	4700	5400	1,5	1,5	1,7	22215	22215 K
	160	37	276	321	3800	4700	2,1	2	3,75	21315	21315 K



MA



MB

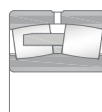

ECA



CC

Main dimensions			Basic load ratings		Speed ratings		Dimensions		Mass	Designation	
d	D	B	Dynamic C	Static C ₀	Reference	Limiting	r _{1,2min}	r _{amax}		Cylindrical bore	Tapered bore
[mm]			[kN]		[rpm]		[mm]		[Kg]	–	
75	160	55	426	469	3000	3600	2,1	2	5,55	22315	22315 K
80	140	33	227	265	4100	5000	2	2	2,1	22216	22216 K
	170	39	317	374	3700	4500	2,1	2	4,45	21316	21316 K
	170	58	477	536	2900	3400	2,1	2	6,6	22316	22316 K
85	150	36	277	323	3800	4600	2	2	2,7	22217	22217 K
	180	41	312	371	3600	4500	3	2,5	5,2	21317	21317 K
	180	60	531	617	2700	3200	3	2,5	7,65	22317	22317 K
90	160	40	314	373	3600	4400	2	2	3,4	22218	22218 K
	160	52,4	345	437	2700	3200	2	2	4,65	23218	23218 K
	190	43	369	441	3400	4100	3	2,5	6,1	21318	21318 K
	190	64	587	690	2500	2900	3	2,5	9,05	22318	22318 K
95	170	43	366	446	3400	4000	2,1	2	4,15	22219	22219 K
	200	45	410	488	3200	3800	3	2,5	7,05	21319	21319 K
	200	67	647	762	2500	2900	3	2,5	10,5	22319	22319 K
100	150	50	275	408	2600	3300	1,5	1,5	3,15	24020	24020 K30
	165	52	353	483	2800	3400	2	2	4,55	23120	23120 K
	165	65	444	631	2300	2600	2	2	5,65	24120	24120 K30
	180	46	414	482	3300	3700	2,1	2	4,9	22220	22220 K
	180	60,3	458	590	2300	2700	2,1	2	6,85	23220	23220 K
	215	47	413	486	3300	3700	3	2,5	8,6	21320	21320 K
110	170	45	299	432	3200	3600	2	2	3,8	23022	23022 K
	170	60	402	619	2300	3100	2	2	5	24022	24022 K30
	180	56	420	578	2700	3000	2	2	5,75	23122	23122 K
	180	69	508	741	1900	2500	2	2	7,1	24122	24122 K30
	200	53	545	629	2900	3400	2,1	2	7	22222	22222 K
	200	69,8	583	759	2100	2700	2,1	2	9,85	23222	23222 K
	240	80	922	1100	1900	2300	3	2,5	18,5	22322	22322 K
120	180	46	347	508	3100	3300	2	2	4,2	23024	23024 K
	180	60	416	662	2300	2900	2	2	5,45	24024	24024 K30
	200	62	491	683	2500	2900	2	2	8	23124	23124 K
	200	80	635	940	1800	2200	2	2	10,5	24124	24124 K30
	205	68	504	844	1600	1800	2,1	2	9,2	231581	–
	215	58	608	753	2700	3200	2,1	2	8,7	22224	22224 K
	215	76	675	912	1900	2300	2,1	2	12	23224	23224 K

Spherical roller bearings

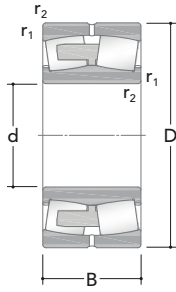

CA/CAF

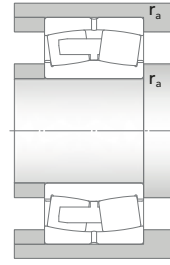

Main dimensions			Basic load ratings		Speed ratings		Dimensions		Mass	Designation	
d	D	B	Dynamic C	Static C ₀	Reference	Limiting	r _{1,2min}	r _{amax}		Cylindrical bore	Tapered bore
[mm]			[kN]		[rpm]		[mm]		[Kg]	-	
120	260	86	927	1090	1900	2100	3	2,5	23	22324	22324 K
130	200	52	417	610	2700	3000	2	2	6	23026	23026 K
	200	69	529	814	1900	2600	2	2	8,05	24026	24026 K30
	210	64	539	766	2300	2700	2	2	8,8	23126	23126 K
	210	80	663	985	1600	1900	2	2	11	24126	24126 K30
	230	64	720	920	2500	3000	3	2,5	11	22226	22226 K
	230	64	625	921	1700	1900	3	2,5	11	29226	22226 K
	230	80	759	1050	1800	2100	3	2,5	14,5	23226	23226 K
	280	93	1090	1290	1700	2000	4	3	29	22326	22326 K
140	210	53	451	672	2500	2900	2	2t	6,55	23028	23028 K
	210	69	553	890	1900	2300	2	2	8,55	24028	24028 K30
	225	68	616	898	2100	2300	2,1	2	10,5	23128	23128 K
	225	85	737	1140	1500	1800	2,1	2	13,5	24128	24128 K30
	250	68	683	893	2300	2600	3	2,5	14	22228	22228 K
	250	88	894	1240	1600	2000	3	2,5	19	23228	23228 K
	300	102	1250	1540	1600	1800	4	3	36,5	22328	22328 K
	150	225	56	499	749	2300	2600	2,1	2	7,95	23030
225		75	638	1030	1700	2100	2,1	2	10,5	24030	24030 K30
250		80	799	1190	1900	2200	2,1	2	16	23130	23130 K
250		100	981	1510	1300	1600	2,1	2	20	24130	24130 K30
270		73	831	1070	2100	2600	3	2,5	18	22230	22230 K
270		96	1040	1430	1500	1800	3	2,5	24,5	23230	23230 K
320		108	1400	1730	1500	1600	4	3	43,5	22330	22330 K
160		220	60	402	834	1300	1400	2	2	6,85	24932
	240	60	573	879	2300	2600	2,1	2	9,7	23032	23032 K
	240	80	727	1180	1600	2000	2,1	2	13	24032	24032 K30
	270	86	946	1360	1800	2000	2,1	2	20,5	23132	23132 K
	270	109	1150	1750	1200	1600	2,1	2	25	24132	24132 K30
	290	80	965	1280	1900	2300	3	2,5	22,5	22232	22232 K
	290	104	1180	1650	1400	1800	3	2,5	31	23232	23232 K
	340	114	1540	1950	1400	1600	4	3	52	22332	22332 K
170	260	67	692	1040	2100	2400	2,1	2	13	23034	23034 K
	260	90	902	1440	1500	2000	2,1	2	17,5	24034	24034 K30
	280	88	1010	1490	1700	2000	2,1	2	22	23134	23134 K
	280	109	1180	1820	1100	1400	2,1	2	27,5	24134	24134 K30
	310	86	1080	1450	1800	2200	4	3	28,5	22234	22234 K

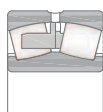

MA



MB

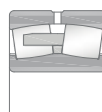

ECA



CC

Main dimensions			Basic load ratings		Speed ratings		Dimensions		Mass	Designation	
d	D	B	Dynamic C	Static C ₀	Reference	Limiting	r _{1,2min}	r _{amax}		Cylindrical bore	Tapered bore
[mm]			[kN]		[rpm]		[mm]		[Kg]	-	
170	310	110	1340	1910	1300	1700	4	3	37,5	23234	23234 K
	360	120	1700	2130	1300	1400	4	3	61	22334	22334 K
180	250	52	475	821	2300	2500	2	2	7,9	23936	23936 K
	280	74	801	1240	1900	2100	2,1	2	17	23036	23036 K
	280	100	1040	1710	1400	1900	2,1	2	23	24036	24036 K30
	300	96	1160	1730	1600	1800	3	2,5	28	23136	23136 K
	300	118	1350	2150	1000	1300	3	2,5	34,5	24136	24136 K30
	320	86	1150	1540	1700	2200	4	3	29,5	22236	22236 K
	320	112	1460	2110	1200	1500	4	3	39,5	23236	23236 K
	380	126	1950	2420	1200	1400	4	3	71,5	22336	22336 K
190	260	52	465	791	2200	2300	2	2	8,3	23938	23938 K
	290	75	844	1330	1800	2000	2,1	2	18	23038	23038 K
	290	100	1090	1770	1300	1700	2,1	2	24,5	24038	24038 K30
	320	104	1330	2060	1400	1600	3	2,5	35	23138	23138 K
	320	128	1550	2470	1000	1200	3	2,5	43	24138	24138 K30
	340	92	1230	1680	1600	2000	4	3	36,5	22238	22238 K
	340	120	1590	2350	1200	1500	4	3	48	23238	23238 K
	400	132	2070	2620	1100	1300	5	4	82,5	22338	22338 K
200	280	60	601	1020	2000	2100	2,1	2	11,5	23940	23940 K
	310	82	961	1500	1700	1800	2,1	2	23,5	23040	23040 K
	310	109	1250	2090	1200	1500	2,1	2	31	24040	24040 K30
	340	112	1560	2350	1400	1500	3	2,5	43	23140	23140 K
	340	140	1750	2750	970	1100	3	2,5	53,5	24140	24140 K30
	360	98	1420	1920	1500	1800	4	3	43,5	22240	22240 K
	360	128	1810	2690	1100	1400	4	3	58	23240	23240 K
	420	138	2260	2860	1100	1200	5	4	95	22340	22340 K
220	300	60	613	1060	1800	1900	2,1	2	12,5	23944	23944 K
	340	90	1180	1830	1500	1700	3	2,5	30,5	23044	23044 K
	340	118	1520	2560	1100	1400	3	2,5	40	24044	24044 K30
	370	120	1740	2740	1200	1400	4	3	53,5	23144	23144 K
	370	150	2070	3330	830	1000	4	3	67	24144	24144 K30
	400	108	1720	2350	1400	1700	4	3	60,5	22244	22244 K
	400	144	2260	3380	1000	1200	4	3	81,5	23244	23244 K
	460	145	2600	3400	960	1100	5	4	120	22344	22344 K
240	320	60	629	1130	1600	1800	2,1	2	13,5	23948	23948 K
	360	92	1240	2040	1400	1600	3	2,5	33,5	23048	23048 K

Spherical roller bearings

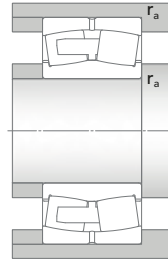
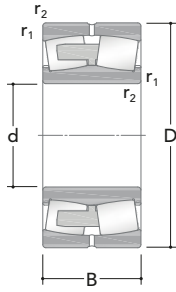

CA/CAF

Main dimensions			Basic load ratings		Speed ratings		Dimensions		Mass	Designation	
d	D	B	Dynamic C	Static C ₀	Reference	Limiting	r _{1,2min}	r _{amax}		Cylindrical bore	Tapered bore
[mm]			[kN]		[rpm]		[mm]		[Kg]	-	
240	360	118	1560	2660	1000	1300	3	2,5	43	24048	24048 K30
	400	128	2000	3180	1100	1300	4	3	66,5	23148	23148 K
	400	160	2310	3880	720	920	4	3	83	24148	24148 K30
	440	120	2130	2940	1200	1400	4	3	83	22248	22248 K
	440	160	2810	4250	920	1100	4	3	110	23248	23248 K
	500	155	2990	3940	910	1000	5	4	155	22348	22348 K
260	320	45	372	916	820	950	2	2	8,05	23852	23852 K
	360	75	976	1790	1400	1800	2,1	2	23,5	23952	23952 K
	360	100	1080	2470	810	940	2,1	2	32	24952	-
	400	104	1550	2520	1200	1400	4	3	48,5	23052	23052 K
	400	140	1970	3440	960	1200	4	3	65,5	24052	24052 K30
	440	144	2450	3830	1000	1100	4	3	90,5	23152	23152 K
	440	180	2920	4730	650	780	4	3	110	24152	24152 K30
	480	130	2570	3520	1100	1300	5	4	110	22252	22252 K
	480	174	3130	4720	810	1000	5	4	140	23252	23252 K
	540	165	3450	4470	820	930	6	5	190	22352	22352 K
280	350	52	491	1150	770	860	2	2	12	23856	23856 K
	380	75	929	1720	1400	1500	2,1	2	25	23956	23956 K
	380	100	1040	2420	780	830	2,1	2	34,5	24956	-
	420	106	1670	2820	1200	1300	4	3	52,5	23056	23056 K
	420	140	2090	3760	920	1100	4	3	69,5	24056	24056 K30
	460	146	2570	4170	970	1100	5	4	97	23156	23156 K
	460	180	2990	5080	600	750	5	4	120	24156	24156 K30
	500	130	2600	3730	1000	1200	5	4	115	22256	22256 K
	500	176	3160	4870	770	900	5	4	150	23256	23256 K
	580	175	3860	5130	770	900	6	5	235	22356	22356 K
300	380	60	623	1530	670	770	2,1	2	17	23860	23860 K
	420	90	1330	2490	1300	1400	3	2,5	39,5	23960	23960 K
	460	118	2050	3410	1100	1200	4	3	71,5	23060	23060 K
	460	160	2620	4710	820	1000	4	3	97	24060	24060 K30
	500	160	3110	5060	920	1000	5	4	125	23160	23160 K
	500	200	3670	6290	540	690	5	4	160	24160	24160 K30
	540	140	3030	4220	960	1200	5	4	135	22260	22260 K
	540	192	3790	5810	730	850	5	4	190	23260	23260 K
	320	400	60	657	1650	920	1000	2,1	2	17,5	23864
440		90	1370	2640	1200	1300	3	2,5	42	23964	23964 K
480		121	2180	3740	1000	1100	4	3	78	23064	23064 K



MA



MB

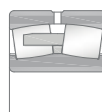

ECA



CC

Main dimensions			Basic load ratings		Speed ratings		Dimensions		Mass	Designation	
d	D	B	Dynamic	Static	Reference	Limiting	r _{1,2min}	r _{amax}		Cylindrical bore	Tapered bore
[mm]			[kN]	C ₀	[rpm]		[mm]		[Kg]	-	
320	480	160	2770	5060	770	990	4	3	100	24064	24064 K30
	540	176	3610	5960	820	910	5	4	165	23164	23164 K
	540	218	4110	7090	480	590	5	4	210	24164	24164 K30
	580	150	3450	4800	910	1000	5	4	175	22264	22264 K
	580	208	4260	6690	670	780	5	4	240	23264	23264 K
340	420	60	674	1700	610	670	2,1	2	18,5	23868	-
	460	90	1410	2740	1200	1400	3	2,5	45,5	23968	23968 K
	520	133	2600	4480	960	1100	5	4	105	23068	23068 K
	520	180	3320	6160	720	950	5	4	140	24068	24068 K30
	580	190	4130	6670	770	860	5	4	210	23168	23168 K
	580	243	5130	8540	410	540	5	4	280	24168	24168 K30
	620	224	4940	7720	540	690	6	5	295	23268	23268 K
360	440	60	687	1840	570	640	2,1	1	20	23872	23872 K
	480	90	1360	2710	1100	1200	3	2,5	46	23972	23972 K
	540	134	2660	4790	920	1000	5	4	110	23072	23072 K
	540	180	3410	6430	670	840	5	4	145	24072	24072 K30
	600	192	4150	6920	720	840	5	4	220	23172	23172 K
	600	243	5420	9290	380	500	5	4	280	24172	24172 K30
	650	170	4170	6080	610	710	6	5	255	22272	22272 K
	650	232	5200	8250	510	640	6	5	335	23272	23272 K
380	520	106	1910	3790	1000	1100	4	3	69	23976	23976 K
	560	135	2800	4920	860	990	5	4	115	23076	23076 K
	560	180	3460	6680	640	810	5	4	150	24076	24076 K30
	620	194	4290	7000	540	850	5	4	230	23176	23176 K
	620	243	5490	9730	340	440	5	4	300	24176	24176 K30
	680	240	5680	9070	480	620	6	5	375	23276	23276 K
400	540	106	1930	3890	1000	1100	4	3	71	23980	23980 K
	600	148	3300	5750	820	920	5	4	150	23080	23080 K
	600	200	4170	7840	610	740	5	4	205	24080	24080 K30
	650	200	4470	7500	500	790	6	5	265	23180	23180 K
	650	250	5950	10390	320	420	6	5	340	24180	24180 K30
	720	256	6410	10280	460	560	6	5	450	23280	23280 K
	820	243	7330	10380	420	620	7,5	6	650	22380	22380 K
420	560	106	1980	4110	910	970	4	3	74,5	23984	23984 K
	620	150	3310	5960	580	940	5	4	155	23084	23084 K
	620	200	4250	8190	510	750	5	4	210	24084	24084 K30

Spherical roller bearings

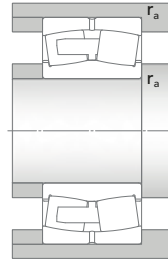
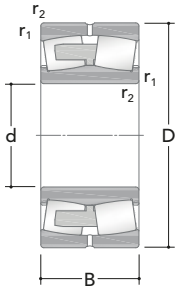

CA/CAF

Main dimensions			Basic load ratings		Speed ratings		Dimensions		Mass	Designation	
d	D	B	Dynamic C	Static C ₀	Reference	Limiting	r _{1,2min}	r _{amax}		Cylindrical bore	Tapered bore
[mm]			[kN]		[rpm]		[mm]		[Kg]	-	
420	700	224	5390	9230	460	770	6	5	350	23184	23184 K
	700	280	7160	12520	310	400	6	5	445	24184	24184 K30
	760	272	7070	11510	430	510	7,5	6	535	23284	23284 K
440	600	118	2360	4860	860	910	4	3	99,5	23988	23988 K
	650	157	3530	6540	540	830	6	5	180	23088	23088 K
	650	212	4620	9090	480	720	6	5	245	24088	24088 K30
	720	226	5800	9970	430	720	6	5	360	23188	23188 K
	720	280	7290	13100	290	380	6	5	460	24188	24188 K30
	790	280	7490	12380	410	490	7,5	6	590	23288	23288 K
	460	580	118	2030	4830	610	920	3	2,5	75,5	24892
620		118	2440	4930	580	860	4	3	105	23992	23992 K
680		163	3790	6820	540	780	6	5	205	23092	23092 K
680		218	5090	9990	470	660	6	5	275	24092	24092 K30
760		240	6250	10660	420	680	7,5	6	440	23192	23192 K
760		300	8070	14350	270	360	7,5	6	560	24192	24192 K30
830		296	8240	13420	380	470	7,5	6	695	23292	23292 K
480		600	90	1390	3690	410	450	3	2,5	61	23896
	650	128	2830	5630	540	850	5	4	125	23996	23996 K
	700	165	3760	6770	510	820	6	5	215	23096	23096 K
	700	218	5140	10300	430	620	6	5	285	24096	24096 K30
	790	248	6780	11950	390	610	7,5	6	485	23196	23196 K
	790	308	8680	15520	250	340	7,5	6	605	24196	24196 K30
	870	310	9050	14750	360	450	7,5	6	800	23296	23296 K
	500	620	90	1440	3980	410	440	3	2,5	62	238/500
670		128	2790	5910	510	820	5	4	130	239/500	239/500 K
720		167	4020	7710	480	750	6	5	225	230/500	230/500 K
720		218	5300	10940	410	600	6	5	295	240/500	240/500 K30
830		264	7380	12840	360	590	7,5	6	580	231/500	231/500 K
830		325	9460	16920	250	310	7,5	6	700	241/500	241/500 K30
920		336	10310	17000	350	410	7,5	6	985	232/500	232/500 K
530	650	118	2050	5230	510	780	3	2,5	86	248/530	248/530 K30
	710	136	3080	6590	480	760	5	4	155	239/530	239/530 K
	780	185	4970	9260	430	680	6	5	310	230/530	230/530 K
	780	250	6480	13040	380	560	6	5	410	240/530	240/530 K30
	870	272	7920	13740	340	570	7,5	6	645	231/530	231/530 K
	870	335	10210	18880	230	300	7,5	6	830	241/530	241/530 K30



MA



MB

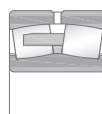

ECA



CC

Main dimensions			Basic load ratings		Speed ratings		Dimensions		Mass	Designation	
d	D	B	Dynamic C	Static C ₀	Reference	Limiting	r _{1,2min}	r _{amax}		Cylindrical bore	Tapered bore
[mm]			[kN]		[rpm]		[mm]		[Kg]	-	
530	980	355	12200	20210	300	390	9,5	8	1200	232/530	232/530 K
560	750	140	3310	7060	430	690	5	4	175	239/560	239/560 K
	820	195	5450	10040	410	630	6	5	355	230/560	230/560 K
	820	258	7120	14590	360	540	6	5	465	240/560	240/560 K30
	920	280	8830	15930	320	530	7,5	6	740	231/560	231/560 K
	920	355	11680	21460	210	270	7,5	6	985	241/560	241/560 K30
	1030	365	12920	21660	270	350	9,5	8	1350	232/560	232/560 K
600	800	150	3740	8130	410	630	5	4	220	239/600	239/600 K
	870	200	5800	11250	380	570	6	5	405	230/600	230/600 K
	870	272	7840	16700	320	470	6	5	520	240/600	240/600 K30
	980	300	9880	17810	310	470	7,5	6	895	231/600	231/600 K
	980	375	12920	23570	190	250	7,5	6	1200	241/600	241/600 K30
	1090	388	14500	25430	250	330	9,5	8	1600	232/600	232/600 K
630	780	112	2430	6050	410	620	4	3	120	238/630	238/630 K
	850	165	4530	9660	390	600	6	5	280	239/630	239/630 K
	920	212	6550	12480	370	560	7,5	6	485	230/630	230/630 K
	920	290	8580	17900	310	430	7,5	6	645	240/630	240/630 K30
	1030	315	11640	20390	250	440	7,5	6	1050	231/630	231/630 K
	1030	400	14010	26730	180	220	7,5	6	1400	241/630	241/630 K30
670	820	112	2520	6270	380	570	4	3	130	238/670	238/670 K
	900	170	4830	10760	340	560	6	5	315	239/670	239/670 K
	980	230	7390	14410	320	510	7,5	6	600	230/670	230/670 K
	980	308	9770	20350	290	410	7,5	6	790	240/670	240/670 K30
	1090	336	12120	21950	230	430	7,5	6	1250	231/670	231/670 K
670	1090	412	15470	28910	170	220	7,5	6	1600	241/670	241/670 K30
	1220	438	17320	30260	210	300	12	10	2270	232/670	232/670 K
710	870	118	2900	7490	340	550	4	3	153	238/710	238/710 K
	950	180	5410	11840	320	500	6	5	365	239/710	239/710 K
	950	243	6650	15580	290	430	6	5	495	249/710	249/710 K30
	1030	236	8120	16280	290	460	7,5	6	670	230/710	230/710 K
	1030	315	10300	22380	250	360	7,5	6	895	240/710	240/710 K30
	1150	345	13500	25600	230	370	9,5	8	1450	231/710	231/710 K
	1150	438	16900	32400	150	200	9,5	8	1900	241/710	241/710 K30
	1280	450	19870	33960	190	270	12	10	2610	232/710	232/710 K
750	920	128	3260	8460	330	500	5	4	185	238/750	238/750 K

Spherical roller bearings

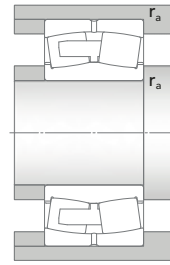
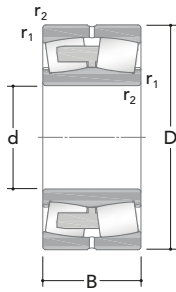

CA/CAF

Main dimensions			Basic load ratings		Speed ratings		Dimensions		Mass	Designation	
d	D	B	Dynamic C	Static C ₀	Reference	Limiting	r _{1,2min}	r _{amax}		Cylindrical bore	Tapered bore
[mm]			[kN]		[rpm]		[mm]		[Kg]	-	
750	1000	185	5810	13060	310	480	6	5	420	239/750	239/750 K
	1000	250	7460	17930	270	410	6	5	560	249/750	249/750 K30
	1090	250	9290	18290	260	430	7,5	6	795	230/750	230/750 K
	1090	335	11390	24630	230	350	7,5	6	1070	240/750	240/750 K30
	1220	365	15090	28930	210	350	9,5	8	1700	231/750	231/750 K
	1220	475	19250	37230	140	180	9,5	8	2100	241/750	241/750 K30
	1360	475	20890	36390	180	260	15	12	3050	232/750	232/750 K
800	980	180	4580	12720	300	460	5	4	300	248/800	248/800 K30
	1060	195	6190	14270	270	450	6	5	470	239/800	239/800 K
	1060	258	7820	19260	230	370	6	5	640	249/800	249/800 K30
	1150	258	9790	19790	250	400	7,5	6	895	230/800	230/800 K
	1150	345	12450	28370	210	340	7,5	6	1200	240/800	240/800 K30
	1280	375	16720	31400	190	330	9,5	8	1920	231/800	231/800 K
	1280	475	20320	40380	130	160	9,5	8	2300	241/800	241/800 K30
	1420	488	23190	42410	170	230	15	12	3280	232/800	232/800 K
850	1030	136	3680	9980	250	450	5	4	240	238/850	238/850 K
	1120	200	6730	15420	250	410	6	5	560	239/850	239/850 K
	1120	272	9030	22600	210	330	6	5	740	249/850	249/850 K30
	1220	272	10370	21180	230	380	7,5	6	1050	230/850	230/850 K
	1220	365	14180	31230	190	310	7,5	6	1410	240/850	240/850 K30
	1360	400	17770	33850	170	290	12	10	2200	231/850	231/850 K
	1360	500	22380	44760	120	150	12	10	2770	241/850	241/850 K30
900	1090	190	5240	15160	230	390	5	4	370	248/900	248/900 K30
	1180	206	7240	16920	230	370	6	5	605	239/900	239/900 K
	1280	280	11170	23040	210	320	7,5	6	1200	230/900	230/900 K
	1280	375	15150	34200	180	270	7,5	6	1570	240/900	240/900 K30
	1420	515	23960	48900	110	150	12	10	3350	241/900	241/900 K30
950	1250	224	8100	19320	210	350	7,5	6	755	239/950	239/950 K
	1250	300	10170	25480	170	290	7,5	6	1020	249/950	249/950 K30
	1360	300	13330	28030	190	310	7,5	6	1450	230/950	230/950 K
	1360	412	16360	38310	160	240	7,5	6	1990	240/950	240/950 K30
	1500	545	26380	54290	100	130	12	10	3540	241/950	241/950 K30
1000	1220	165	5280	14270	210	340	6	5	410	238/1000	238/1000 K
	1320	315	11540	28660	160	270	7,5	6	1200	249/1000	249/1000 K30
	1420	308	14240	30350	170	300	7,5	6	1600	230/1000	230/1000 K
	1420	412	16890	40090	150	220	7,5	6	2140	240/1000	240/1000 K30

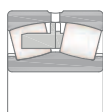

MA



MB

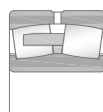

ECA



CC

Main dimensions			Basic load ratings		Speed ratings		Dimensions		Mass	Designation	
d	D	B	Dynamic C	Static C ₀	Reference	Limiting	r _{1,2min}	r _{amax}		Cylindrical bore	Tapered bore
[mm]			[kN]		[rpm]		[mm]		[Kg]	-	
1000	1580	462	23770	47060	130	230	12	10	3500	231/1000	231/1000 K
	1580	580	29510	61860	96	120	12	10	4300	241/1000	241/1000 K30
1060	1280	165	5340	14710	190	310	6	5	435	238/1060	238/1060 K
	1280	218	6750	19840	190	310	6	5	570	248/1060	248/1060 K30
	1400	250	10770	25720	170	300	7,5	6	1100	239/1060	239/1060 K
	1400	335	12860	32330	150	240	7,5	6	1400	249/1060	249/1060 K30
	1500	325	15650	33610	160	270	9,5	8	1840	230/1060	230/1060 K
	1500	438	19430	45120	140	220	9,5	8	2520	240/1060	240/1060 K30
1120	1360	243	8100	23910	170	280	6	5	735	248/1120	248/1120 K30
	1460	335	13320	34240	130	210	7,5	6	1500	249/1120	249/1120 K30
	1580	462	20630	49160	120	200	9,5	8	2930	240/1120	240/1120 K30
1180	1420	180	6450	18460	160	260	6	5	575	238/1180	238/1180 K
	1420	243	8570	26560	160	270	6	5	770	248/1180	248/1180 K30
	1540	272	12300	30970	140	250	7,5	6	1400	239/1180	239/1180 K
	1540	355	15040	40280	120	190	7,5	6	1800	249/1180	249/1180 K30
	1660	475	24000	57900	120	190	9,5	8	3320	240/1180	240/1180 K30
1250	1750	375	19780	44100	120	200	9,5	8	2840	230/1250	230/1250 K
1320	1600	280	10920	33340	130	220	6	5	1160	248/1320	248/1320 K30
	1720	400	17980	48350	100	170	7,5	6	2500	249/1320	249/1320 K30
1500	1820	315	14170	44140	100	180	7,5	6	1710	248/1500	248/1500 K30
	1950	450	20230	62830	72	110	9,5	8	3550	249/1500	249/1500 K30
1800	2180	375	19300	62690	70	110	9,5	8	2900	248/1800	248/1800 K30

Spherical roller bearings special designs

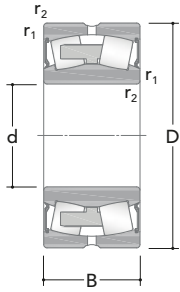

Sealed

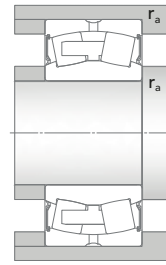

Main dimensions			Basic load ratings		Speed ratings	Dimensions		Mass	Designation	
d	D	B	Dynamic C	Static C ₀	Limiting	r _{1,2min}	r _{amax}		Cylindrical bore	Tapered bore
[mm]			[kN]		[rpm]	[mm]		[Kg]	–	–
25	52	23	47,80	43,80	3500	1	1	0,26	BS2 2205 2CS	–
30	62	25	62,60	59,30	2700	1	1	0,34	BS2 2206 2CS	–
35	72	28	83,30	84,40	2300	1,1	1	0,52	BS2 2207 2CS	–
40	80	28	92,90	88,50	2100	1,1	1	0,57	BS2 2208 2CS	BS2 2208 K2CS
	90	38	145	139	1800	1,5	1,5	1,2	BS2 2308 2CS	–
45	85	28	98,70	97,70	1900	1,1	1	0,66	BS2 2209 2CS	BS2 2209 K2CS
	100	42	178	180	1400	1,5	1,5	1,6	BS2 2309 2CS	–
50	90	28	101	107	1800	1,1	1	0,7	BS2 2210 2CS	BS2 2210 K2CS
	110	45	215	221	1300	2	2	2,1	BS2 2310 2CS	–
55	100	31	122	125	1600	1,5	1,5	1	BS2 2211 2CS	BS2 2211 K2CS
	120	49	263	278	1300	2	2	2,8	BS2 2311 2CS	–
60	110	34	152	166	1500	1,5	1,5	1,3	BS2 2212 2CS	BS2 2212 K2CS
	130	53	298	329	1000	2,1	2	3,4	BS2 2312 2CS	–
65	100	35	128	172	1100	1,1	1	0,95	24013 2CZ	–
	120	38	185	214	1400	1,5	1,5	1,6	BS2 2213 2CS	BS2 2213 K2CS
	140	56	333	360	970	2,1	2	4,15	BS2 2313 2CS	–
70	125	38	202	224	1300	1,5	1,5	1,8	BS2 2214 2CS	BS2 2214 K2CS
	150	60	388	426	870	2,1	2	5,1	BS2 2314 2CS	–
75	115	40	169	229	960	1,1	1	1,55	24015 2CS	–
	130	38	204	235	1200	1,5	1,5	2,1	BS2 2215 2CS	BS2 2215 K2CS
	160	64	428	472	920	2,1	2	6,5	BS2 2315 2CS	–
80	140	40	229	270	1100	2	2	2,4	BS2 2216 2CS	BS2 2216 K2CS
	170	67	479	533	780	2,1	2	7,2	BS2 2316 2CS	–
85	150	44	278	321	1000	2	2	3	BS2 2217 2CS	BS2 2217 K2CS
90	160	48	316	372	970	2	2	3,7	BS2 2218 2CS	BS2 2218 K2CS
	160	52,4	345	437	730	2	2	4,65	23218 2CZ	–
95	170	51	372	445	930	2,1	2	4,65	BS2 2219 2CS	BS2 2219 K2CS

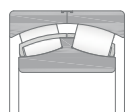

WOR



CC/ECCS

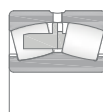

ROVSX



SSRB

Main dimensions			Basic load ratings		Speed ratings	Dimensions		Mass	Designation	
d	D	B	Dynamic C	Static C ₀	Limiting	r _{1,2min}	r _{amax}		Cylindrical bore	Tapered bore
[mm]			[kN]		[rpm]	[mm]		[Kg]	–	–
100	150	50	275	408	770	1,5	1,5	3,15	24020 2CZ	–
	165	52	353	483	830	2	2	4,55	23120 2CZ	–
	165	65	444	631	640	2	2	5,65	24120 2CZ	–
	180	55	412	484	870	2,1	2	5,5	BS2 2220 2CS	BS2 2220 K2CS
	180	60,3	458	590	670	2,1	2	6,85	23220 2CZ	–
110	170	45	298	432	870	2	2	3,8	23022 2CZ	–
	170	60	402	619	640	2	2	5	24022 2CZ	–
	180	56	420	578	770	2	2	5,75	23122 2CZ	23122 K2CZ
	180	69	508	741	610	2	2	7,1	24122 2CZ	–
	200	63	546	636	770	2,1	2	7,6	BS2 2222 2CS	BS2 2222 K2CS
	200	69,8	583	758	620	2,1	2	9,85	23222 2CZ	23222 K2CZ
120	180	46	347	508	820	2	2	4,2	23024 2CZ	–
	180	60	416	662	640	2	2	5,45	24024 2CZ	–
	200	80	635	940	530	2	2	10,5	24124 2CZ	–
	215	69	605	750	720	2,1	2	9,75	BS2 2224 2CS	BS2 2224 K2CS
	215	76	675	912	580	2,1	2	12	23224 2CZ	23224 K2CZ
	260	86	927	1090	570	3	2,5	23	22324 2CZ	22324 K2CZ
	130	200	52	417	610	770	2	2	6	23026 2CZ
200		69	529	814	580	2	2	8,05	24026 2CZ	–
210		80	663	985	510	2	2	11	24126 2CZ	–
230		75	709	926	670	3	2,5	11	BS2 2226 2CS	BS2 2226 K2CS
230		80	759	1050	510	3	2,5	14,5	23226 2CZ	23226 K2CZ
280		93	1090	1290	480	4	3	29	22326 2CZ	22326 K2CZ
140		210	53	450	672	680	2	2	6,55	23028 2CZ
	210	69	552	890	530	2	2	8,55	24028 2CZ	–
	225	85	737	1140	430	2,1	2	13,5	24128 2CZ	–
	250	68	683	893	640	3	2,5	14	22228 2CZ	22228 K2CZ
	250	88	894	1240	460	3	2,5	19	23228 2CZ	23228 K2CZ
	300	102	1250	1540	410	4	3	36,5	22328 2CZ	22328 K2CZ
	150	225	56	499	749	650	2,1	2	7,95	23030 2CZ
225		75	638	1030	510	2,1	2	10,5	24030 2CZ	–
250		80	799	1190	540	2,1	2	16	23130 2CZ	23130 K2CZ
250		100	981	1510	390	2,1	2	20	24130 2CZ	–
270		73	831	1070	610	3	2,5	18	22230 2CZ	22230 K2CZ
270		96	1040	1430	410	3	2,5	24,5	23230 2CZ	23230 K2CZ
320		108	1400	1730	380	4	3	43,5	22330 2CZ	22330 K2CZ

Spherical roller bearings special designs

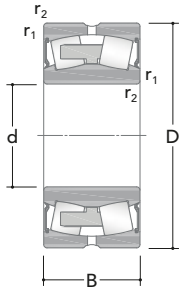

Sealed

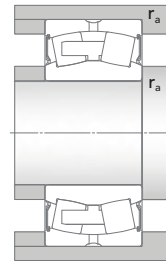

Main dimensions			Basic load ratings		Speed ratings	Dimensions		Mass	Designation	
d	D	B	Dynamic C	Static C ₀	Limiting	r _{1,2min}	r _{amax}		Cylindrical bore	Tapered bore
[mm]			[kN]		[rpm]	[mm]		[Kg]	-	
160	240	60	573	879	650	2,1	2	9,7	23032 2CZ	23032 K2CZ
	240	80	727	1180	430	2,1	2	13	24032 2CZ	-
	270	86	946	1360	510	2,1	2	20,5	23132 2CZ	23132 K2CZ
	270	109	1150	1750	370	2,1	2	25	24132 2CZ	-
	290	80	965	1280	570	3	2,5	22,5	22232 2CZ	22232 K2CZ
	340	114	1540	1950	360	4	3	52	22332 2CZ	22332 K2CZ
170	260	67	692	1040	600	2,1	2	13	23034 2CZ	23034 K2CZ
	260	90	902	1440	380	2,1	2	17,5	24034 2CZ	-
	280	88	1010	1490	470	2,1	2	22	23134 2CZ	23134 K2CZ
	280	109	1180	1820	350	2,1	2	27,5	24134 2CZ	-
	310	86	1080	1450	480	4	3	28,5	22234 2CZ	22234 K2CZ
180	280	74	801	1240	540	2,1	2	17	23036 2CZ	23036 K2CZ
	280	100	1040	1710	360	2,1	2	23	24036 2CZ	-
	300	96	1160	1730	410	3	2,5	28	23136 2CZ	23136 K2CZ
	300	118	1350	2150	350	3	2,5	34,5	24136 2CZ	-
	320	86	1150	1540	510	4	3	29	22236 2CZ	22236 K2CZ
190	320	104	1330	2060	380	3	2,5	35	23138 2CZ	23138 K2CZ
	320	128	1550	2470	320	3	2,5	43	24138 2CZ	-
	340	92	1230	1680	460	4	3	35	22238 2CZ	22238 K2CZ
200	310	82	961	1500	460	2,1	2	22	23040 2CZ	23040 K2CZ
	340	112	1560	2350	370	3	2,5	43	23140 2CZ	23140 K2CZ
	340	140	1750	2750	300	3	2,5	53,5	24140 2CZ	-
	360	98	1420	1920	420	4	3	42	22240 2CZ	22240 K2CZ
	360	128	1810	2690	330	4	3	58	23240 2CZ	23240 K2CZ
220	300	60	613	1060	570	2,1	2	12,5	23944 2CZ	-
	340	90	1180	1830	410	3	2,5	29	23044 2CZ	23044 K2CZ
	370	120	1740	2740	340	4	3	53,5	23144 2CZ	23144 K2CZ
	400	108	1720	2350	360	4	3	58	22244 2CZ	22244 K2CZ
	460	145	2600	3400	290	5	4	115	22344 2CZ	22344 K2CZ
240	360	92	1240	2040	380	3	2,5	32	23048 2CZ	23048 K2CZ
	400	128	2000	3180	330	4	3	66,5	23148 2CZ	23148 K2CZ
260	400	104	1550	2520	350	4	3	46	23052 2CZ	23052 K2CZ
	440	144	2450	3830	300	4	3	90,5	23152 2CZ	23152 K2CZ

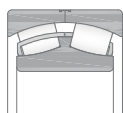

WOR



CC/ECCS

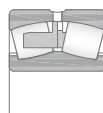

ROVSX



SSRB

Main dimensions			Basic load ratings		Speed ratings	Dimensions		Mass	Designation	
d	D	B	Dynamic C	Static C ₀	Limiting	r _{1,2min}	r _{amax}		Cylindrical bore	Tapered bore
[mm]			[kN]		[rpm]	[mm]		[Kg]	-	
280	460	146	2570	4170	290	5	4	97	23156 2CZ	23156 K2CZ
300	500	160	3114,80	5066,21	252	5	4	125	23160 2CZ	23160 K2CZ
320	540	176	3618,09	5968,95	252	5	4	165	23164 2CZ	23164 K2CZ
340	580	190	4131,10	6677,76	231	5	4	210	23168 2CZ	23168 K2CZ
360	600	192	4153,93	6922,41	214	5	4	214	23172 2CZ	23172 K2CZ
400	650	200	4471,06	7508,61	146	6	5	255	23180 2CZ	23180 K2CZ

Spherical roller bearings special designs

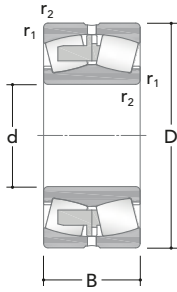

ROVSX

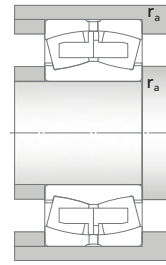

Main dimensions			Basic load ratings		Speed ratings		Dimensions		Mass	Designation	
d	D	B	Dynamic C	Static C ₀	Reference	Limiting	r _{1,2min}	r _{amax}		Cylindrical bore	Tapered bore
[mm]			[kN]		[rpm]		[mm]		[Kg]	-	
40	90	33	147	140	5800	6700	1,5	1,5	1,05	22308 ROVSX	22308 KROVSX
45	100	36	179	180	5100	5900	1,5	1,5	1,4	22309 ROVSX	22309 KROVSX
50	110	40	213	224	4600	5300	2	2	1,9	22310 ROVSX	22310 KROVSX
55	120	43	264	279	4200	4800	2	2	2,45	22311 ROVSX	22311 KROVSX
60	130	46	299	333	3800	4400	2,1	2	3,1	22312 ROVSX	22312 KROVSX
65	140	48	327	353	3600	4200	2,1	2	3,75	22313 ROVSX	22313 KROVSX
70	150	51	389	423	3300	3700	2,1	2	4,55	22314 ROVSX	22314 KROVSX
75	160	55	426	474	3000	3600	2,1	2	5,55	22315 ROVSX	22315 KROVSX
80	170	58	479	533	2900	3400	2,1	2	6,6	22316 ROVSX	22316 KROVSX
85	180	60	538	617	2700	3200	3	2,5	7,65	22317 ROVSX	22318 KROVSX
90	190	64	588	684	2500	3000	3	2,5	9,05	22318 ROVSX	22318 KROVSX
95	200	67	645	760	2500	2800	3	2,5	10,5	22319 ROVSX	22319 KROVSX
100	215	73	785	943	2300	2400	3	2,5	13,5	22320 ROVSX	22320 KROVSX
110	240	80	917	1100	1900	2300	3	2,5	18,5	22322 ROVSX	22322 KROVSX
120	260	86	942	1110	1900	2200	3	2,5	23	22324 ROVSX	22324 KROVSX
130	280	93	1070	1310	1700	2000	4	3	29	22326 ROVSX	22327 KROVSX
140	300	102	1250	1530	1600	1800	4	3	36,5	22328 ROVSX	22328 KROVSX
150	320	108	1420	1740	1500	1700	4	3	43,5	22330 ROVSX	22330 KROVSX
160	340	114	1560	1950	1400	1600	4	3	52	22332 ROVSX	22332 KROVSX
170	360	120	1700	2130	1300	1500	4	3	61	22334 ROVSX	22334 KROVSX
180	380	126	1950	2410	1200	1400	4	3	71,5	22336 ROVSX	22336 KROVSX



ECCS



Sealed

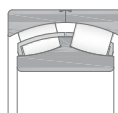

WOR



SPLIT

Main dimensions			Basic load ratings		Speed ratings		Dimensions		Mass	Designation	
d	D	B	Dynamic C	Static C ₀	Reference	Limiting	r _{1,2min}	r _{amax}		Cylindrical bore	Tapered bore
[mm]			[kN]		[rpm]		[mm]		[Kg]	–	
190	400	132	2050	2640	1100	1300	5	4	82,5	22338 ROVSX	22338 KROVSX
200	420	138	2270	2890	1100	1200	5	4	95	22340 ROVSX	22340 KROVSX
220	460	145	2630	3390	970	1100	5	4	120	22344 ROVSX	22344 KROVSX
240	500	155	3010	3920	920	1000	5	4	155	22348 ROVSX	22348 KROVSX



Toroidal roller bearings

Toroidal roller bearings.....	273
Internal clearance.....	273
Misalignment	273
Axial displacement	274
Minimum load	274
Designs and variants	277
Type J	277
Type V	277
Sealed type	277
Prefixes.....	278
Suffixes.....	278
Product tables.....	279

Toroidal roller bearings

The RKB toroidal roller bearings (TORB) are single row pure radial roller bearings featuring slim symmetrical barrel rollers, properly profiled to grant an uniform stress distribution, as well as a proper roller/raceway contact.

This proper pressure distribution along all the roller profile allow to control rolling friction and working temperature, keeping them at their minimum values. Consequently the lube film gap remains stable and the lubricant ageing process is reduced also, improving the application reliability.

According to the internal design RKB TORB bearings are conceived to be mounted as non-locating bearings, since they can face the thermal expansion along the shaft. RKB TORB bearings are manufactured offering the highest load rating capacities, improved internal geometry, high quality materials and special heat treatments for superior performance.



TORB bearings

Internal clearance

TORB bearings are produced as standard with Normal radial internal clearance CN, but they are also available with C2, C3, C4 and C5 radial internal clearance.

The radial internal clearance are reported for bearing with:

- cylindrical bore in the **Tab. 4 page 275**;
- tapered bore in the **Tab. 5 page 276**;

and they are valid only for bearing unmounted, unloaded and without any axial displacement of one ring in respect to the other one.

Axial displacement of one ring in respect to the other one reduces gradually the radial internal clearance, but if the axial displacement is not generated by the shaft thermal expansion, the radial internal clearance will be lightly affected (see the following paragraph "Axial displacement").

TORB bearings are often used together with the spherical roller bearings and their radial internal clearance is slightly larger than the spherical roller bearings of the same size. In order to achieve approximatively the same operational clearance value of spherical roller bearing of the same size, it is required only an axial displacement between one ring in respect to the other one of 6 - 8 % of TORB bearing width.

Misalignment

The internal design of the TORB bearings can accommodate a misalignment of approximatively 0.5° between inner ring and outer ring without affects negatively the bearing life. Greater misalignments increase the friction inside, so the bearing life will be negatively influenced. For additional information, please consult the RKB application engineering service.

In case of TORB bearing with brass cage guided on the inner ring, a misalignment value of 0.5° must not be exceeded. Also in application considered stationary, the value of the misalignment has to be reduced.

Considering also that the axial displacement leads the rollers head to approach the ring faces, its reduction is suggested (please see the following axial displacement paragraph).

Axial displacement

The internal design of the TORB bearings can accommodate axial displacements between inner rings and outer rings, which can be generated by a thermal expansion or its deviation from a determinate position. Any misalignment or axial displacement reduces the bearing radial internal clearance. In order to accommodate the axial displacement it is necessary a defined space on both bearing sides and that the rollers must remaining inside the bearing raceways without touching eventual seals or locking rings.

With this axial displacement the bearing radial internal clearance decreases and it is important that it remains acceptable for the application. The maximum value of the axial displacement from the normal position of one ring relative to the other one has to be the lower among:

- the clearance reduction,
- the axial displacement of the rollers.

For additional information, please consult the RKB application engineering service.

Minimum load

A minimum radial load is requested for a TORB bearing, like for all ball and roller bearings, in order to guarantee the correct functioning condition, especially in particularly difficult working conditions: high speed, high acceleration and sudden changes of direction. In these operating conditions a sliding movement between the rollers and raceways can be generated by the inertial forces, influencing negatively the bearing life. Minimum radial load for TORB bearing with/without cage can be theoretically estimated using this formula:

$$\frac{F_{rm}}{C_0} > 0,023$$

Where:

- F_{rm} minimum radial load, [kN];
- C_0 basic static radial load, [kN].

Usually, the minimum radial load is reached or surpassed by the weight of the components supported by the bearing and the loads acting on it, otherwise supplementary radial load must be applied on the TORB bearing.

Toroidal roller bearings

d [mm]		Radial internal clearance [µm]									
		C2		CN		C3		C4		C5	
over	incl.	min.	max.	min.	max.	min.	max.	min.	max.	min.	max.
18	24	15	30	25	40	35	55	50	65	65	85
24	30	15	35	30	50	45	60	60	80	75	95
30	40	20	40	35	55	55	75	70	95	90	120
40	50	25	45	45	65	65	85	85	110	105	140
50	65	30	55	50	80	75	105	100	140	135	175
65	80	40	70	65	100	95	125	120	165	160	210
80	100	50	85	80	120	120	160	155	210	205	260
100	120	60	100	100	145	140	190	185	245	240	310
120	140	75	120	115	170	165	215	215	280	280	350
140	160	85	140	135	195	195	250	250	325	320	400
160	180	95	155	150	220	215	280	280	365	360	450
180	200	105	175	170	240	235	310	305	395	390	495
200	225	115	190	185	265	260	340	335	435	430	545
225	250	125	205	200	285	280	370	365	480	475	605
250	280	135	225	220	310	305	410	405	520	515	655
280	315	150	240	235	330	330	435	430	570	570	715
315	355	160	260	255	360	360	485	480	620	620	790
355	400	175	280	280	395	395	530	525	675	675	850
400	450	190	310	305	435	435	580	575	745	745	930
450	500	205	335	335	475	475	635	630	815	810	1 015
500	560	220	360	360	520	510	690	680	890	890	1 110
560	630	240	400	390	570	560	760	750	980	970	1 220
630	710	260	440	430	620	610	840	830	1 080	1 070	1 340
710	800	300	500	490	680	680	920	920	1 200	1 200	1 480
800	900	320	540	530	760	750	1 020	1 010	1 330	1 320	1 660
900	1 000	370	600	590	830	830	1 120	1 120	1 460	1 460	1 830
1 000	1 120	410	660	660	930	930	1 260	1 260	1 640	1 640	2 040
1 120	1 250	450	720	720	1 020	1 020	1 380	1 380	1 800	1 800	2 240
1 250	1 400	490	800	800	1 130	1 130	1 510	1 510	1 970	1 970	2 460
1 400	1 600	570	890	890	1 250	1 250	1 680	1 680	2 200	2 200	2 740
1 600	1 800	650	1 010	1 010	1 390	1 390	1 870	1 870	2 430	2 430	3 000

Tab. 4 - Radial internal clearance of TORB bearings with cylindrical bore

d [mm]		Radial internal clearance [μm]									
		C2		CN		C3		C4		C5	
over	incl.	min.	max.	min.	max.	min.	max.	min.	max.	min.	max.
18	24	15	35	30	45	40	55	55	70	65	85
24	30	20	40	35	55	50	65	65	85	80	100
30	40	25	50	45	65	60	80	80	100	100	125
40	50	30	55	50	75	70	95	90	120	115	145
50	65	40	65	60	90	85	115	110	150	145	185
65	80	50	80	75	110	105	140	135	180	175	220
80	100	60	100	95	135	130	175	170	220	215	275
100	120	75	115	115	155	155	205	200	255	255	325
120	140	90	135	135	180	180	235	230	295	290	365
140	160	100	155	155	215	210	270	265	340	335	415
160	180	115	175	170	240	235	305	300	385	380	470
180	200	130	195	190	260	260	330	325	420	415	520
200	225	140	215	210	290	285	365	360	460	460	575
225	250	160	235	235	315	315	405	400	515	510	635
250	280	170	260	255	345	340	445	440	560	555	695
280	315	195	285	280	380	375	485	480	620	615	765
315	355	220	320	315	420	415	545	540	680	675	850
355	400	250	350	350	475	470	600	595	755	755	920
400	450	280	385	380	525	525	655	650	835	835	1 005
450	500	305	435	435	575	575	735	730	915	910	1 115
500	560	330	480	470	640	630	810	800	1 010	1 000	1 230
560	630	380	530	530	710	700	890	880	1 110	1 110	1 350
630	710	420	590	590	780	770	990	980	1 230	1 230	1 490
710	800	480	680	670	860	860	1 100	1 100	1 380	1 380	1 660
800	900	520	740	730	960	950	1 220	1 210	1 530	1 520	1 860
900	1 000	580	820	810	1 040	1 040	1 340	1 340	1 670	1 670	2 050
1 000	1 120	640	900	890	1 170	1 160	1 500	1 490	1 880	1 870	2 280
1 120	1 250	700	980	970	1 280	1 270	1 640	1 630	2 060	2 050	2 500
1 250	1 400	770	1 080	1 080	1 410	1 410	1 790	1 780	2 250	2 250	2 740
1 400	1 600	870	1 200	1 200	1 550	1 550	1 990	1 990	2 500	2 500	3 050
1 600	1 800	950	1 320	1 320	1 690	1 690	2 180	2 180	2 730	2 730	3 310

Tab. 5 - Radial internal clearance of TORB bearings with tapered bore

Designs and variants

Type J

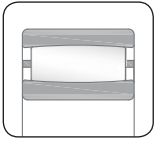

- Non-separable compact design
- Can be used only in a non-locating position
- Available with tapered and cylindrical bore
- Very high self-aligning and axial displacement properties
- The radial internal clearance depends on the rings axial relative position

Type V

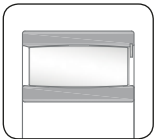

- Non-separable compact design
- Can be used only in a non-locating position
- Available with tapered and cylindrical bore
- Very high self-aligning and axial displacement properties
- Full complement (cageless) design for increased load carrying capacities
- Reduced maximum rotational speed compared to caged design
- Asymmetrical permissible axial displacement (limited in snap ring side)

Sealed type

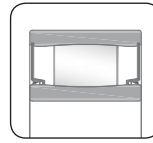

- Non-separable compact design
- Can be used only in a non-locating position
- High self-aligning and axial displacement properties
- Full complement (cageless) design
- Integral rubber seals on both bearing sides for harsh working conditions
- Supplied already filled with grease for maintenance free operations

Prefixes	Basic designation
TORB	Toroidal roller bearing followed by size indication or drawing number
SB	Toroidal roller bearing followed by size indication or drawing number

Suffixes	Cage
V	Full complement of rolling elements (without cage)
J	Pressed steel cage

Suffixes	External design
2CS	NBR seal on both sides
FF	FKM seal on both sides
K	Tapered bore, taper 1:12
K30	Tapered bore, taper 1:30

Toroidal roller bearings

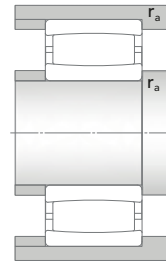
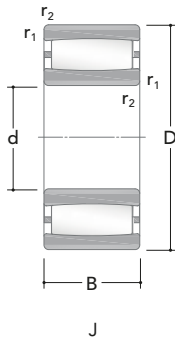

Main dimensions			Basic load ratings		Speed ratings		Dimensions		Mass	Designation	
d	D	B	Dynamic C	Static C ₀	Reference	Limiting	r _{1,2min}	r _{amax}		Cylindrical bore	Tapered bore
[mm]			[kN]		[rpm]		[mm]		[Kg]	-	
25	52	18	42,6	39,5	12500	15200	1	1	0,17	TORB 2205	TORB 2205 K
	52	18	48,2	48,2	-	6000	1	1	0,18	TORB 2205 V	TORB 2205 KV
30	55	45	129	178	-	2600	1	1	0,49	TORB 6006 V	-
	62	20	67,4	60,8	10600	12300	1	1	0,28	TORB 2206	TORB 2206 K
	62	20	74,7	70,0	-	5100	1	1	0,29	TORB 2206 V	TORB 2206 KV
35	72	23	81,3	79,2	9300	11300	1,1	1	0,44	TORB 2207	TORB 2207 K
	72	23	92,8	94,7	-	4300	1,1	1	0,46	TORB 2207 V	TORB 2207 KV
40	62	22	73,6	99,2	-	3500	0,6	0,6	0,25	TORB 4908 V	TORB 4908 K30V
	62	30	102	142	-	2800	0,6	0,6	0,35	TORB 5908 V	-
	62	40	118	180	-	2400	0,6	0,6	0,45	TORB 6908 V	-
	80	23	86,7	85,9	7700	9400	1,1	1	0,51	TORB 2208	TORB 2208 K
	80	23	98,2	103	-	3700	1,1	1	0,53	TORB 2208 V	TORB 2208 KV
45	68	22	79,0	111	-	3200	0,6	0,6	0,29	TORB 4909 V	TORB 4909 K30V
	68	30	106	162	-	2600	0,6	0,6	0,41	TORB 5909 V	-
	68	40	127	197	-	2100	0,6	0,6	0,53	TORB 6909 V	-
	85	23	89,5	91,4	7200	9200	1,1	1	0,56	TORB 2209	TORB 2209 K
	85	23	102	109	-	3600	1,1	1	0,58	TORB 2209 V	TORB 2209 KV
50	72	22	83,6	125	-	3000	0,6	0,6	0,29	TORB 4910 V	TORB 4910 K30V
	72	30	110	173	-	2300	0,6	0,6	0,41	TORB 5910 V	-
	72	40	135	220	-	1900	0,6	0,6	0,54	TORB 6910 V	-
	80	30	112	138	5400	6300	1	1	0,55	TORB 4010	TORB 4010 K30
	80	30	133	174	-	2500	1	1	0,58	TORB 4010 V	TORB 4010 K30V
	90	23	95,1	99,1	6700	8100	1,1	1	0,6	TORB 2210	TORB 2210 K
	90	23	111	122	-	3200	1,1	1	0,63	TORB 2210 V	TORB 2210 KV
55	80	25	103	151	-	2700	1,5	1,5	0,42	TORB 4911 V	TORB 4911 K30V
	80	34	138	221	-	2100	1	1	0,6	TORB 5911 V	-
	80	45	173	295	-	1800	1	1	0,78	TORB 6911 V	-
	100	25	112	112	6000	7500	1,5	1,5	0,8	TORB 2211	TORB 2211 K
	100	25	128	132	-	2800	1,5	1,5	0,82	TORB 2211 V	TORB 2211 KV
60	85	25	109	169	-	2500	1	1	0,46	TORB 4912 V	TORB 4912 K30V
	85	34	144	236	-	2000	1	1	0,64	TORB 5912 V	-
	110	28	140	154	5400	6200	1,5	1,5	1,1	TORB 2212	TORB 2212 K
	110	28	160	188	-	2300	1,5	1,5	1,15	TORB 2212 V	TORB 2212 KV

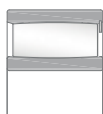

V

Main dimensions			Basic load ratings		Speed ratings		Dimensions		Mass	Designation	
d	D	B	Dynamic C	Static C ₀	Reference	Limiting	r _{1,2min}	r _{amax}		Cylindrical bore	Tapered bore
[mm]			[kN]		[rpm]		[mm]		[Kg]	–	
65	90	25	113	179	–	2300	1	1	0,5	TORB 4913 V	TORB 4913 K30V
	90	34	150	258	–	1800	1	1	0,68	TORB 5913 V	–
	90	45	191	352	–	1500	1	1	0,9	TORB 6913 V	–
	100	35	187	297	–	2000	1,1	1	1,05	TORB 4013 V	TORB 4013 K30V
	120	31	173	179	5000	6300	1,5	1,5	1,45	TORB 2213	TORB 2213 K
	120	31	197	215	–	2000	1,5	1,5	1,5	TORB 2213 V	TORB 2213 KV
70	100	30	157	160	–	2100	1	1	0,78	TORB 4914 V	TORB 4914 K30V
	100	40	192	307	–	1600	1	1	1	TORB 5914 V	–
	100	54	259	449	–	1400	1	1	1,4	TORB 6914 V	–
	125	31	181	193	4800	5900	1,5	1,5	1,5	TORB 2214	TORB 2214 K
	125	31	204	226	–	1900	1,5	1,5	1,55	TORB 2214 V	TORB 2214 KV
	150	51	395	428	3700	4100	2,1	2	4,3	TORB 2314	TORB 2314 K
75	105	30	160	253	–	1900	1	1	0,82	TORB 4915 V	TORB 4915 K30V
	105	40	200	321	–	1600	1	1	1,1	TORB 5915 V	–
	105	54	199	321	–	1600	1	1	1,4	TORB 6915 V	–
	115	40	201	340	–	1600	1,1	1	1,6	TORB 4015 V	TORB 4015 K30V
	130	31	190	208	4600	5600	1,5	1,5	1,6	TORB 2215	TORB 2215 K
	130	31	215	237	–	1800	1,5	1,5	1,65	TORB 2215 V	TORB 2215 KV
	160	55	416	464	3500	4100	2,1	2	5,3	TORB 2315	TORB 2315 K
80	110	30	169	274	–	1800	1	1	0,86	TORB 4916 V	TORB 4916 K30V
	110	40	204	341	–	1400	1	1	1,15	TORB 5916 V	–
	140	33	212	246	4100	5000	2	2	2,05	TORB 2216	TORB 2216 K
	140	33	246	300	–	1600	2	2	2,15	TORB 2216 V	TORB 2216 KV
	170	58	495	550	3200	3800	2,1	2	6,3	TORB 2316	TORB 2316 K
85	120	35	217	351	–	1600	1,1	1	1,3	TORB 4917 V	TORB 4917 K30V
	120	46	265	463	–	1400	1,1	1	1,7	TORB 5917 V	–
	150	36	264	314	3800	4700	2	2	2,65	TORB 2217	TORB 2217 K
	150	36	307	388	–	1500	2	2	2,8	TORB 2217 V	TORB 2217 KV
	180	60	523	599	3000	3600	3	2,5	7,4	TORB 2317	TORB 2317 K
90	125	35	181	313	–	1700	1,1	1	1,3	TORB 4918 V	TORB 4918 K30V
	125	46	187	324	2500	3300	1,1	1	1,75	TORB 5918	–
	125	46	217	399	–	1300	1,1	1	1,75	TORB 5918 V	–
	150	72	440	661	–	1230	2	2	5,1	BSC-2039 V	–
	160	40	312	373	3600	4400	2	2	3,3	TORB 2218	TORB 2218 K
	160	40	352	433	–	1300	2	2	3,45	TORB 2218 V	TORB 2218 KV
	190	64	588	690	2600	3400	3	2,5	8,65	TORB 2318	TORB 2318 K

Toroidal roller bearings

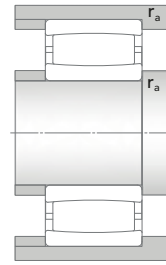
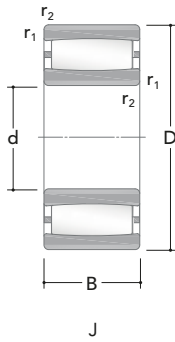

Main dimensions			Basic load ratings		Speed ratings		Dimensions		Mass	Designation	
d	D	B	Dynamic C	Static C ₀	Reference	Limiting	r _{1,2min}	r _{amax}		Cylindrical bore	Tapered bore
[mm]			[kN]		[rpm]		[mm]		[Kg]	-	
95	170	43	316	373	3600	4500	2,1	2	4,1	TORB 2219	TORB 2219 K
	200	67	587	683	2600	3400	3	2,5	10	TORB 2319	TORB 2319 K
100	140	40	233	447	-	1400	1,1	1	2,05	TORB 4920 V	TORB 4920 K30V
	140	54	362	636	-	1100	1,1	1	2,7	TORB 5920 V	-
	150	50	345	520	-	1100	1,5	1,5	3,05	TORB 4020 V	TORB 4020 K30V
	150	67	492	860	-	950	1,5	1,5	4,3	TORB 5020 V	-
	165	52	462	651	-	1000	2	2	4,45	TORB 3120 V	TORB 3120 KV
	165	65	460	653	-	1000	2	2	5,3	TORB 4120 V	TORB 4120 K30V
	180	46	406	464	3500	3900	2,1	2	4,95	TORB 2220	TORB 2220 K
	215	73	774	869	2500	3100	3	2,5	12,5	TORB 2320	TORB 2320 K
110	170	45	341	471	3000	3600	2	2	3,6	TORB 3022	TORB 3022 K
	170	60	416	653	2500	2800	2	2	5,3	TORB 4022	TORB 4022 K30
	170	60	490	800	-	1000	2	2	5,2	TORB 4022 V	TORB 4022 K30V
	180	69	652	984	-	770	2	2	7,1	TORB 4122 V	TORB 4122 K30V
	200	53	510	609	3000	3700	2,1	2	7	TORB 2222	TORB 2222 K
120	180	46	364	520	2900	3500	2	2	3,95	TORB 3024	TORB 3024 K
	180	46	418	628	-	1100	2	2	4,1	TORB 3024 V	TORB 3024 KV
	180	60	419	630	-	1200	2	2	5,05	TORB 4024	TORB 4024 K30
	180	60	514	870	-	920	2	2	5,55	TORB 4024 V	TORB 4024 K30V
	200	80	758	1090	-	610	2	2	10	TORB 4124 V	TORB 4124 K30V
	215	58	591	702	2700	3400	2,1	2	8,65	TORB 2224	TORB 2224 K
	215	76	734	968	2300	2700	2,1	2	12	TORB 3224	TORB 3224 K
	130	200	52	381	577	2700	3100	2	2	5,9	TORB 3026
200		69	603	913	2100	2400	2	2	7,85	TORB 4026	TORB 4026 K30
200		69	702	1110	-	710	2	2	8,15	TORB 4026 V	TORB 4026 K30V
210		80	727	1090	-	710	2	2	10,5	TORB 4126 V	TORB 4126 K30V
230		64	707	922	2600	3200	3	2,5	11,5	TORB 2226	TORB 2226 K
140	210	53	480	727	2500	2800	2	2	6,3	TORB 3028	TORB 3028 K
	210	69	723	1210	-	660	2	2	8,6	TORB 4028 V	TORB 4028 K30V
	225	85	762	1180	-	660	2,1	2	12,5	TORB 4128 V	TORB 4128 K30V
	250	68	801	1040	2300	2600	3	2,5	14	TORB 2228	TORB 2228 K
150	225	56	519	833	2300	2700	2,1	2	8,45	TORB 3030	TORB 3030 K
	225	56	564	955	-	850	2,1	2	8	TORB 3030 V	TORB 3030 KV
	225	75	751	1310	-	630	2,1	2	10,5	TORB 4030 V	TORB 4030 K30V

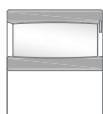

V

Main dimensions			Basic load ratings		Speed ratings		Dimensions		Mass	Designation	
d	D	B	Dynamic C	Static C ₀	Reference	Limiting	r _{1,2min}	r _{amax}		Cylindrical bore	Tapered bore
[mm]			[kN]		[rpm]		[mm]		[Kg]	-	
150	250	80	860	1270	1900	2300	2,1	2	15,5	TORB 3130	TORB 3130 K
	250	100	1180	1840	-	360	2,1	2	20	TORB 4130 V	TORB 4130 K30V
	270	73	949	1200	2300	2600	3	2,5	18	TORB 2230	TORB 2230 K
160	240	60	587	978	2100	2500	2,1	2	9,6	TORB 3032	TORB 3032 K
	240	80	736	1130	1600	1900	2,1	2	12,5	TORB 4032	TORB 4032 K30
	240	80	895	1440	-	490	2,1	2	13	TORB 4032 V	TORB 4032 K30V
	270	86	967	1380	1800	2200	2,1	2	21,5	TORB 3132	TORB 3132 K
	270	109	1410	2150	-	250	2,1	2	26	TORB 4132 V	TORB 4132 K30V
	290	104	1330	1790	1700	2000	3	2,5	29,5	TORB 3232	TORB 3232 K
170	260	67	727	1140	1900	2300	2,1	2	12,5	TORB 3034	TORB 3034 K
	260	90	1110	1850	-	420	2,1	2	17,5	TORB 4034 V	TORB 4034 K30V
	280	88	1010	1450	1800	2200	2,1	2	21	TORB 3134	TORB 3134 K
	280	109	1490	2270	-	230	2,1	2	27	TORB 4134 V	TORB 4134 K30V
	310	86	1240	1610	1800	2200	4	3	28	TORB 2234	TORB 2234 K
180	280	74	846	1310	1900	2100	2,1	2	17	TORB 3036	TORB 3036 K
	280	100	1290	2110	-	370	2,1	2	23,5	TORB 4036 V	TORB 4036 K30
	300	96	1200	1720	1600	1900	3	2,5	26,5	TORB 3136	TORB 3136 K
	300	118	1700	2660	-	190	3	2,5	34,5	TORB 4136 V	TORB 4136 K30
	320	112	1480	2190	1400	1700	4	3	38	TORB 3236	TORB 3236 K
190	290	75	899	1450	1700	2000	2,1	2	17,5	TORB 3038	TORB 3038 K
	290	100	1310	2300	-	310	2,1	2	24	TORB 4038 V	TORB 4038 K30V
	320	104					3	2,5	33,5	TORB 3138	-
	320	104	1630	2500	-	160	3	2,5	34,5	TORB 3138 V	TORB 3138 KV
	320	128	1970	3130	-	110	3	2,5	43	TORB 4138 V	TORB 4138 K30V
	340	92	1310	1700	1700	2000	4	3	34,5	TORB 2238	TORB 2238 K
200	310	82	1080	1700	1600	1900	2,1	2	22,5	TORB 3040	TORB 3040 K
	310	109	1560	2600	-	210	2,1	2	30,5	TORB 4040 V	TORB 4040 K30V
	340	112	1560	2290	1400	1600	3	2,5	41	TORB 3140	TORB 3140 K
	340	140	2260	3610	-	60	3	2,5	54	TORB 4140 V	-
220	340	90	1280	2020	1500	1800	3	2,5	29,5	TORB 3044	TORB 3044 K
	340	118	1860	3230	-	170	3	2,5	40	TORB 4044 V	TORB 4044 K30V
	370	120	1820	2840	1300	1500	4	3	52	TORB 3144	TORB 3144 K
	400	108	1930	2490	1400	1700	4	3	57,5	TORB 2244	TORB 2244 K
240	360	92	1280	2110	1400	1700	3	2,5	32	TORB 3048	TORB 3048 K

Toroidal roller bearings

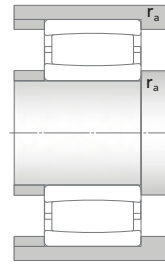
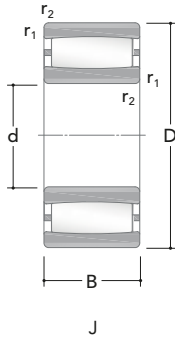

Main dimensions			Basic load ratings		Speed ratings		Dimensions		Mass	Designation	
d	D	B	Dynamic C	Static C ₀	Reference	Limiting	r _{1,2min}	r _{amax}		Cylindrical bore	Tapered bore
[mm]			[kN]		[rpm]		[mm]		[Kg]	-	
240	400	128	2240	3400	1200	1400	4	3	64	TORB 3148	TORB 3148 K
260	400	104	1700	2810	1200	1500	4	3	47	TORB 3052	TORB 3052 K
	440	144	2540	4010	1000	1200	4	3	88	TORB 3152	TORB 3152 K
280	420	106	1790	3080	1100	1300	4	3	50,5	TORB 3056	TORB 3056 K
	460	146	2790	4490	1000	1200	5	4	94,5	TORB 3156	TORB 3156 K
300	460	118	2110	3740	1000	1300	4	3	72	TORB 3060	TORB 3060 K
	460	160	2830	4830	870	1000	4	3	95,5	TORB 4060	TORB 4060 K30
	500	160	3120	5100	910	1100	5	4	125	TORB 3160	TORB 3160 K
320	480	121	2210	3960	970	1100	4	3	78	TORB 3064	TORB 3064 K
	540	176	4000	6190	860	1000	5	4	164	TORB 3164	TORB 3164 K
340	520	133	2820	4970	920	1100	5	4	100	TORB 3068	TORB 3068 K
	580	190	4770	7390	820	940	5	4	205	TORB 3168	TORB 3168 K
360	480	90	1690	3220	960	1100	3	2,5	45	TORB 3972	TORB 3972 K
	540	134	2780	4900	860	1000	5	4	106	TORB 3072	TORB 3072 K
	600	192	4820	7950	770	900	5	4	220	TORB 3172	TORB 3172 K
380	520	106	2060	3940	920	1100	4	3	66	TORB 3976	TORB 3976 K
	560	135	2880	5100	860	1000	5	4	110	TORB 3076	TORB 3076 K
	620	194	4300	7110	730	830	5	4	243	TORB 3176	TORB 3176 K
400	540	106	2040	3980	860	1100	4	3	68,5	TORB 3980	TORB 3980 K
	600	148	3510	6160	770	917	5	4	145	TORB 3080	TORB 3080 K
	650	200	4630	8260	670	810	6	5	258	TORB 3180	TORB 3180 K
420	560	106	2100	4220	820	1000	4	3	72	TORB 3984	TORB 3984 K
	620	150	3650	6340	760	910	5	4	150	TORB 3084	TORB 3084 K
	700	224	5780	10330	640	770	6	5	355	TORB 3184	TORB 3184 K
440	600	118	2530	5270	780	910	4	3	99	TORB 3988	TORB 3988 K
	650	157	3640	6350	720	850	6	5	190	TORB 3088	TORB 3088 K
	720	226	6540	11360	610	720	6	5	385	TORB 3188	TORB 3188 K
	720	280	7260	12740	480	560	6	5	471	TORB 4188	TORB 4188 K30
460	620	118	2610	5290	770	940	4	3	100	TORB 3992	TORB 3992 K
	680	163	3890	7450	680	780	6	5	205	TORB 3092	TORB 3092 K

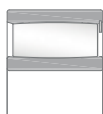

V

Main dimensions			Basic load ratings		Speed ratings		Dimensions		Mass	Designation	
d	D	B	Dynamic C	Static C ₀	Reference	Limiting	r _{1,2min}	r _{amax}		Cylindrical bore	Tapered bore
[mm]			[kN]		[rpm]		[mm]		[Kg]	-	
460	760	240	6650	11870	580	680	7,5	6	435	TORB 3192	TORB 3192 K
	760	300	8430	14760	460	510	7,5	6	571	TORB 4192	TORB 4192 K30
480	650	128	3020	6010	730	830	5	4	120	TORB 3996	TORB 3996 K
	700	165	3890	7730	640	740	6	5	215	TORB 3096	TORB 3096 K
	790	248	6710	12440	540	620	7,5	6	523	TORB 3196	TORB 3196 K
500	670	128	3070	6270	680	800	5	4	125	TORB 39/500	TORB 39/500 K
	720	167	4130	8160	610	760	6	5	225	TORB 30/500	TORB 30/500 K
	830	264	7260	12680	510	650	7,5	6	560	TORB 31/500	TORB 31/500 K
	830	325	9590	17410	420	480	7,5	6	710	TORB 41/500	TORB 41/500 K30
530	710	136	3410	7050	640	760	5	4	150	TORB 39/530	TORB 39/530 K
	780	185	4910	9330	570	680	6	5	300	TORB 30/530	TORB 30/530 K
	870	272	8610	15580	480	580	7,5	6	636	TORB 31/530	TORB 31/530 K
560	750	140	3510	7320	580	720	5	4	175	TORB 39/560	TORB 39/560 K
	820	195	5460	10840	510	610	6	5	350	TORB 30/560	TORB 30/560 K
	920	280	8840	16240	460	580	7,5	6	789	TORB 31/560	TORB 31/560 K
	920	355	10030	19500	360	420	7,5	6	1010	TORB 41/560	TORB 41/560 K30
600	800	150	3860	8750	540	640	5	4	215	TORB 39/600	TORB 39/600 K
	870	200	6150	12040	480	590	6	5	395	TORB 30/600	TORB 30/600 K
	980	300	9860	17760	410	500	7,5	6	929	TORB 31/600	TORB 31/600 K
	980	375	12460	22880	320	380	7,5	6	1150	TORB 41/600	TORB 41/600 K30
630	850	165	4530	9860	510	580	6	5	275	TORB 39/630	TORB 39/630 K
	920	212	6580	12750	460	570	7,5	6	470	TORB 30/630	TORB 30/630 K
	1030	315	11480	20650	380	470	7,5	6	1090	TORB 31/630	TORB 31/630 K
670	900	170	4730	11040	460	520	6	5	315	TORB 39/670	TORB 39/670 K
	980	230	7930	16180	410	510	7,5	6	590	TORB 30/670	TORB 30/670 K
	1090	336	11480	20850	360	410	7,5	6	1300	TORB 31/670	TORB 31/670 K
710	950	180	5840	12430	430	530	6	5	360	TORB 39/710	TORB 39/710 K
	1030	236	8450	16970	380	470	7,5	6	655	TORB 30/710	TORB 30/710 K
	1030	315	10290	21410	310	370	7,5	6	865	TORB 40/710	TORB 40/710 K30
	1150	345	12930	25370	320	400	9,5	8	1470	TORB 31/710	TORB 31/710 K
750	1000	185	5880	13320	410	470	6	5	410	TORB 39/750	TORB 39/750 K
	1000	250	7580	17160	330	390	6	5	604	TORB 49/750	TORB 49/750 K

Toroidal roller bearings

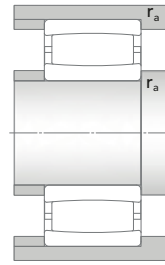
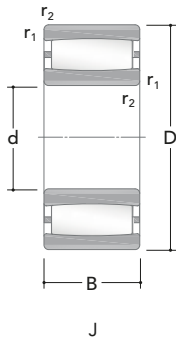

Main dimensions			Basic load ratings		Speed ratings		Dimensions		Mass	Designation		
d	D	B	Dynamic C	Static C ₀	Reference	Limiting	r _{1,2min}	r _{amax}		Cylindrical bore	Tapered bore	
[mm]			[kN]		[rpm]		[mm]		[Kg]	-		
750	1090	250	9190	19060	360	440	7,5	6	838	TORB 30/750	TORB 30/750 K	
		1220	365	15440	300040	300	380	9,5	8	1810	TORB 31/750	TORB 31/750 K
800	1060	195	6150	14320	360	440	6	5	480	TORB 39/800	TORB 39/800 K	
		1150	258	8930	19120	340	410	7,5	6	941	TORB 30/800	TORB 30/800 K
		1280	375	15140	26480	290	330	9,5	8	2030	TORB 31/800	TORB 31/800 K
850	1120	200	7200	16130	350	410	6	5	540	TORB 39/850	TORB 39/850 K	
		1220	272	11150	24050	300	380	7,5	6	1110	TORB 30/850	TORB 30/850 K
		1360	400	16250	33460	270	320	12	10	2450	TORB 31/850	TORB 31/850 K
900	1180	206	8060	18240	340	380	6	5	633	TORB 39/900	TORB 39/900 K	
		1280	280	12220	26310	280	330	7,5	6	1200	TORB 30/900	TORB 30/900 K
950	1250	224	9100	21750	290	360	7,5	6	784	TORB 39/950	TORB 39/950 K	
		1360	300	12860	28070	270	320	7,5	6	1480	TORB 30/950	TORB 30/950 K
1000	1420	308	13200	30000	250	300	7,5	6	1680	TORB 30/1000	TORB 30/1000 K	
		1580	462	19590	45060	210	250	12	10	3800	TORB 31/1000	TORB 31/1000 K
1060	1400	250	10690	25790	250	290	7,5	6	1120	TORB 39/1060	TORB 39/1060 K	
1180	1540	272	13020	33240	210	250	7,5	6	1400	TORB 39/1180	TORB 39/1180 K	
1250	1750	375	21540	48470	170	200	9,5	8	2980	TORB 30/1250	TORB 30/1250 K	
1320	1600	280	10310	30270	180	210	6	5	1250	TORB 48/1320	TORB 48/1320 K30	
1500	1950	335	18900	47260	130	160	9,5	8	2710	TORB 39/1500	TORB 39/1500 K	



V

Toroidal roller bearings

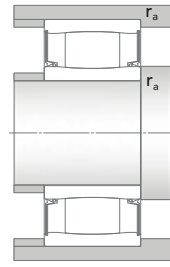
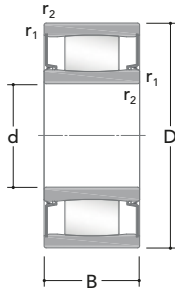

Sealed

Main dimensions			Basic load ratings		Speed ratings	Dimensions		Mass	Designation
d	D	B	Dynamic C	Static C ₀	Limiting	r _{1,2min}	r _{amax}		
[mm]			[kN]		[rpm]	[mm]		[Kg]	-
50	72	40	135	221	160	0,6	0,6	0,56	TORB 6910 V2CS
65	100	35	100	171	120	1,1	1	1,05	TORB 4013 V2CS
75	105	54	198	321	120	1	1	1,4	TORB 6915 V2CS
	115	40	140	192	110	1,1	1	1,4	TORB 4015 V2CS
90	125	46	217	399	93	1,1	1	1,75	TORB 5918 V2CS
100	150	50	300	444	81	1,5	1,5	2,9	TORB 4020 V2CS
	165	65	461	649	75	2	2	5,2	TORB 4120 V2CS
110	170	60	402	578	71	2	2	4,6	TORB 4022 V2CS
	180	69	485	702	66	2	2	6,6	TORB 4122 V2CS
120	180	60	413	634	68	2	2	5,1	TORB 4024 V2CS
	200	80	688	990	65	2	2	9,7	TORB 4124 V2CS
130	200	69	530	825	59	2	2	7,5	TORB 4026 V2CS
	210	80	733	1098	57	2	2	10,5	TORB 4126 V2CS
140	210	69	555	886	55	2	2	7,9	TORB 4028 V2CS
	225	85	760	1180	53	2,1	2	12,5	TORB 4128 V2CS
150	225	75	572	953	53	2,1	2	10	TORB 4030 V2CS
	250	100	1180	1850	50	2,1	2	20,5	TORB 4130 V2CS
160	240	80	629	1080	50	2,1	2	12	TORB 4032 V2CS
	270	109	1430	2130	44	2,1	2	26	TORB 4132 V2CS
170	260	90	930	1600	44	2,1	2	17	TORB 4034 V2CS
	280	109	1480	2260	45	2,1	2	27	TORB 4134 V2CS
180	280	100	1278	2090	46	2,1	2	23,5	TORB 4036 V2CS
	300	118	1710	2670	41	3	2,5	35	TORB 4136 V2CS
190	290	100	1333	2280	40	2,1	2	24,5	TORB 4038 V2CS
	320	128	1970	3130	38	3	2,5	43,5	TORB 4138 V2CS
200	310	109	1587	2630	38	2,1	2	31	TORB 4040 V2CS
	340	140	2260	3570	35	3	2,5	54,5	TORB 4140 V2CS



Thrust bearings

Thrust ball bearings	293
Single direction thrust ball bearings.....	293
Misalignment.....	293
Minimum load	293
Designs and variants	295
Type 51M.....	295
Variant 53M+U	295
Prefixes.....	296
Suffixes.....	296
Product tables.....	297
Double direction thrust ball bearings	307
Minimum load	307
Designs and variants	308
Type 52M.....	308
Product tables.....	309
Cylindrical roller thrust bearings	311
Single direction cylindrical roller thrust bearings	311
Misalignment.....	311
Minimum load	311
Designs and variants	313
Type 81M.....	313
Type 81M+U.....	313
Type 89M.....	313
Prefixes.....	314
Suffixes.....	314
Product tables.....	315
Double direction cylindrical roller thrust bearings.....	321
Misalignment.....	321
Minimum load	321
Designs and variants	322
Type WS+GS.....	322
Tapered roller thrust bearings	323
Single direction tapered roller thrust bearings	323

Misalignment.....	323
Minimum load	324
Designs and variants.....	325
Type TK1	325
Type TK2	325
Type TK3	325
Type TK4	325
Type TKSD1	325
Type TKSD2	325
Type TKSD3	326
Type TKSD4	326
Type TKSD5	326
Suffixes.....	327
Prefixes.....	327
Product tables.....	329
Double direction tapered roller thrust bearings.....	337
Misalignment	337
Minimum load	337
Designs and variants.....	338
Type TTK1	338
Type TTK2	338
Type TTK ^{SP}	338
Product tables.....	339
Spherical roller thrust bearings	341
Single direction spherical roller thrust bearings	341
Misalignment.....	342
Minimum load	342
Designs and variants.....	343
Type EM.....	343
Type EM ^{Evo}	343
Type EJ	343
Suffixes.....	344
Product tables.....	345

RKB
BEARING INDUSTRIES
SWITZERLAND

Thrust ball bearings

The thrust ball bearings (TBBs) manufactured by RKB are designed to support high axial loads and, in some cases, even moderate radial loads. The manufacturing program includes single and double direction TBBs with flat or spherical housing washers to meet any requirements in various industrial applications. Thanks to the improved internal geometry and the use of the most suitable raw materials, all RKB TBBs attain the highest axial load ratings and the best reliability.

Depending on application requirements, RKB Bainite Hardening Treatment (HB) and High Temperature Dimensional Stabilization (S) can be applied on bearing rings and rolling elements. The bearing dimensional and running accuracy conforms to ISO/ABMA/GOST specifications.

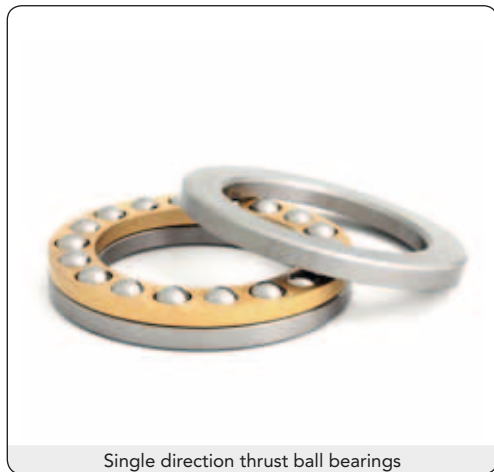

Single direction thrust ball bearings

Single direction thrust ball bearings

Single direction thrust ball bearings are composed of a shaft washers, housing washers and cage-balls assembly. Bearings are separable so washers and cage-balls assembly can be mounted separately. Axial deep groove ball bearings of series 511, 512, 513, 514 that have an flat housing washers, can support only axial forces in one direction and they cannot support any radial load and any misalignment.

Bearings of series 532 and 533 can support axial force in one direction, but having a spherical housing washer and matched with seating washer U2 and U3, they are able to compensate a misalignment between shaft and housing. No radial load can be supported.

Misalignment

Thrust ball bearings with flat washers do not have possibility to accommodate any misalignment between shaft and housing and any alignment errors between support surfaces in the housing and on the shaft. In presence of misalignment between the support surfaces in the housing and on the shaft, a thrust ball bearing with sphered housing washers matched with sphered seat washers should be used.

Minimum load

A minimum axial load is requested for a thrust ball bearing, like for all ball and roller bearings, to operate correctly, especially in critical application requirements like: high speed, high acceleration and sudden changes of rotating direction. In these operating conditions a skidding between the balls and raceways can be generated by the inertial forces, influencing negatively the bearing life. To calculate the minimum axial load please consult the RKB application engineering service.

However, the minimum axial load is reached or surpassed by the weight of the components

supported by the bearing, mostly when the shaft is vertical and the loads acting on it. If the minimum axial load is not reached or in case of application where a starting up at low temperature is planned or a lubricant with high viscosity is used, it will be necessary to preload the thrust ball bearings by springs or shaft nut. For additional information, please consult the RKB application engineering service.

Single direction thrust ball bearings

Designs and variants

Type 51M

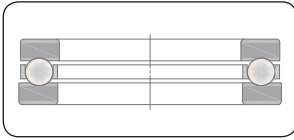

HB
BAINITE HT

S
STABILIZATION

- Flat housing locating washer
- Separable design
- One-piece machined brass cage (M) guided on balls
- Supports unidirectional axial loads

Variant 53M+U



HB
BAINITE HT

S
STABILIZATION

- Sphered housing washer
- Separable design
- One-piece machined brass cage (M) guided on balls
- Supports unidirectional axial loads
- The sphered housing washer is mounted on a locating sphered seating washer to accommodate shaft misalignment

Prefixes

TBB	Out of standard thrust ball bearing followed by drawing number
U	Sphered housing washer associated to related thrust ball bearing

Suffixes | **Internal design**

SP	Special or non-standard bearing
----	---------------------------------

Suffixes | **Cage**

M	Machined brass cage guided on balls
F or MF	Machined steel cage guided balls

Suffixes | **Accuracy, clearance, running**

P6S	Dimensional and running accuracy between P6 and P5
-----	--

Single direction thrust ball bearings

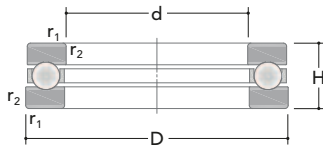

51M



Main dimensions			Basic load ratings		Speed ratings		Dimensions		Mass	Designation
d	D	H	Dynamic C	Static C ₀	Reference	Limiting	r _{1,2min}	r _{amax}		
[mm]			[kN]		[rpm]		[mm]		[Kg]	—
10	24	9	9,68	15,0	9200	10900	0,3	0,3	0,02	51100
	26	11	12,2	18,3	7700	9000	0,6	0,6	0,03	51200
12	26	9	10,0	16,3	8600	10700	0,3	0,3	0,022	51101
	28	11	13,0	20,5	7800	9500	0,6	0,6	0,034	51201
15	28	9	10,2	18,1	8100	9800	0,3	0,3	0,023	51102
	32	12	15,5	24,9	6800	8500	0,6	0,6	0,046	51202
17	30	9	11,1	21,2	8200	10100	0,3	0,3	0,025	51103
	35	12	15,9	26,6	6500	8000	0,6	0,6	0,053	51203
20	35	10	14,7	28,8	7300	8500	0,3	0,3	0,037	51104
	40	14	20,5	37,3	5700	6500	0,6	0,6	0,083	51204
25	42	11	17,6	38,9	6000	7700	0,6	0,6	0,056	51105
	47	15	25,8	49,1	5100	6200	0,6	0,6	0,11	51205
	52	18	33,8	59,9	4400	5200	1	1	0,17	51305
	60	24	41,0	66,3	3400	4200	1	1	0,34	51405
30	47	11	18,4	42,9	5800	7100	0,6	0,6	0,063	51106
	52	16	24,5	50,3	4600	5800	0,6	0,6	0,13	51206
	60	21	34,6	64,6	3600	4400	1	1	0,26	51306
	70	28	67,5	121	2800	3700	1	1	0,52	51406
35	52	12	19,3	50,5	5400	6400	0,6	0,6	0,08	51107
	62	18	34,1	72,9	3800	4700	1	1	0,22	51207

Main dimensions			Basic load ratings		Speed ratings		Dimensions		Mass	Designation
d	D	H	Dynamic C	Static C ₀	Reference	Limiting	r _{1,2min}	r _{amax}		
[mm]			[kN]		[rpm]		[mm]		[Kg]	–
35	68	24	47,6	94,9	3200	3900	1	1	0,39	51307
	90	32	74,5	136	2500	3000	1,1	1	0,79	51407
40	60	13	24,6	62,1	4800	5900	0,6	0,6	0,12	51108
	68	19	43,1	96,0	3700	4300	1	1	0,28	51208
	78	26	60,4	122	2900	3600	1	1	0,53	51308
	90	36	91,9	180	2300	2800	1,1	1	1,1	51408
45	65	14	25,5	68,3	4300	5300	0,6	0,6	0,14	51109
	73	20	37,5	84,9	3400	4300	1	1	0,3	51209
	85	28	73,9	152	2700	3200	1	1	0,66	51309
	100	39	121	236	2100	2500	1,1	1	1,4	51409
50	70	14	26,0	73,7	4100	5300	0,6	0,6	0,16	51110
	78	22	48,4	116	3300	3800	1	1	0,37	51210
	95	31	79,0	167	2500	3100	1,1	1	0,94	51310
	110	43	155	335	1900	2300	1,5	1,5	2	51410
55	78	16	29,4	80,9	3600	4300	0,6	0,6	0,23	51111
	90	25	56,8	133	2700	3200	1	1	0,59	51211
	105	35	97,3	220	2100	2600	1,1	1	1,3	51311
	120	48	191	399	1700	2000	1,5	1,5	2,55	51411
60	85	17	40,0	121	3400	4100	1	1	0,27	51112
	95	26	57,4	140	2700	3100	1	1	0,65	51212
	110	35	97,1	222	2100	2500	1,1	1	1,35	51312
	130	51	193	430	1500	1800	1,5	1,5	3,1	51412
65	90	18	36,8	108	3300	3900	1	1	0,33	51113
	100	27	58,9	149	2500	3000	1	1	0,72	51213
	115	36	103	240	1900	2600	1,1	1	1,5	51313
	140	56	208	481	1400	1800	2	2	4	51413
70	95	18	39,1	120	3200	3800	1	1	0,35	51114
	105	27	61,0	160	2500	3100	1	1	0,79	51214
	125	40	131	317	1800	2100	1,1	1	2	51314
	150	60	225	540	1300	1600	2	2	5	51414
75	100	19	42,6	133	3000	3600	1	1	0,4	51115
	110	27	61,4	167	2300	2800	1	1	0,83	51215
	135	44	158	387	1600	2000	1,5	1,5	2,6	51315

Single direction thrust ball bearings

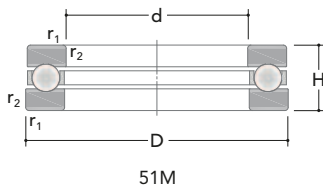

Main dimensions			Basic load ratings		Speed ratings		Dimensions		Mass	Designation
d	D	H	Dynamic C	Static C ₀	Reference	Limiting	r _{1,2min}	r _{amax}		
[mm]			[kN]		[rpm]		[mm]		[Kg]	—
75	160	65	243	604	1200	1500	2	2	6,75	51415
80	105	19	43,4	138	2900	3600	1	1	0,42	51116
	115	28	73,6	207	2300	2900	1	1	0,91	51216
	140	44	155	388	1600	2000	1,5	1,5	2,7	51316
	170	68	291	737	1100	1400	2,1	2	7,95	51416
85	110	19	43,5	146	2900	3600	1	1	0,44	51117
	125	31	93,9	273	2100	2500	1	1	1,2	51217
	150	49	168	404	1500	1900	1,5	1,5	3,55	51317
	180	72	278	736	1100	1300	2,1	2	9,45	51417
90	120	22	57,7	205	2500	3200	1	1	0,67	51118
	135	35	109	286	1900	2300	1,1	1	1,7	51218
	155	50	178	435	1400	1800	1,5	1,5	3,8	51318
	190	77	300	812	1000	1200	2,1	2	11	51418
100	135	25	78,9	265	2300	2700	1	1	0,97	51120
	150	38	115	323	1700	1900	1,1	1	2,2	51220
	170	55	217	561	1300	1500	1,5	1,5	4,95	51320
	170	55	218	600	920	1100	15	1,5	5,40	51320
	210	85	362	1040	920	1100	3	2,5	15	51420
110	145	25	79,9	279	2100	2600	1	1	1,05	51122
	160	38	120	361	1600	2000	1,1	1	2,4	51222
	190	63,5	271	804	1100	1400	2	2	7,85	51322
	197	86	432	1220	—	—	3	2,5	11,50	351977
	230	95	401	1210	870	1100	3	2,5	20	51422
120	155	25	83,4	305	2100	2500	1	1	1,15	51124
	155	25	80,6	297	1500	1800	1	1	1,25	51124
	170	39	122	383	1500	1800	1,1	1	2,65	51224
	210	70	313	963	1000	1200	2,1	2	11	51324
	250	102	423	1310	780	950	4	3	25,5	51424
130	170	30	114	432	1800	2100	1	1	1,85	51126
	190	45	179	574	1300	1600	1,5	1,5	4	51226
	225	75	344	1110	960	1200	2,1	2	13	51326
	270	110	500	1690	720	820	4	3	32	51426
140	180	31	107	437	1700	2100	1	1	2,05	51128

Main dimensions			Basic load ratings		Speed ratings		Dimensions		Mass	Designation
d	D	H	Dynamic C	Static C ₀	Reference	Limiting	r _{1,2min}	r _{amax}		
[mm]			[kN]		[rpm]		[mm]		[Kg]	–
140	200	46	185	610	1300	1600	1,5	1,5	4,35	51228
	240	80	363	1190	910	1000	2,1	2	15,5	51328
	280	112	505	1690	670	850	4	3	34,5	51428
150	165	15,175	15,8	77,3	1800	2400	0,6	0,5	0,40	634133
	190	31	108	433	1600	2000	1	1	2,2	51130
	215	50	231	786	1200	1400	1,5	1,5	6,1	51230
	250	80	379	1260	870	1000	2,1	2	16,5	51330
	300	120	537	1940	640	780	4	3	42,5	51430
160	200	31	109	463	1600	1900	1	1	2,35	51132
	225	51	233	830	1100	1400	1,5	1,5	6,55	51232
	270	87	433	1650	810	980	3	2,5	21	51332
170	215	34	128	535	1500	1800	1,1	1	3,3	51134
	240	51	264	920	1100	1400	1,5	1,5	8,15	51234
	280	87	450	1740	760	910	3	2,5	22	51334
180	225	34	131	563	1400	1800	1,1	1	3,5	51136
	250	51	294	1110	1100	1300	1,5	1,5	8,6	51236
	300	95	506	1960	720	900	3	2,5	28,5	51336
190	240	37	167	696	1300	1700	1,1	1	4,05	51138
	270	51	324	1250	1000	1300	2	2	12	51238
	320	105	538	2150	670	810	4	3	36,5	51338
200	250	37	164	701	1300	1600	1,1	1	4,25	51140
	280	51	330	1310	1000	1200	2	2	12	51240
	340	110	606	2570	610	740	4	3	44,5	51340
220	270	37	172	799	1200	1600	1,1	1	4,6	51144
	300	63	349	1450	920	1000	2	2	13	51244
240	300	45	226	1020	1000	1300	1,5	1,5	7,55	51148
	340	78	437	1920	770	930	2,1	2	23	51248
260	320	45	229	1090	1000	1200	1,5	1,5	8,1	51152
	360	79	469	2210	720	930	2,1	2	25	51252
	480	175	1060	5390	280	340	6	5	135,00	51452
280	350	53	310	1440	920	1100	1,5	1,5	12	51156

Single direction thrust ball bearings

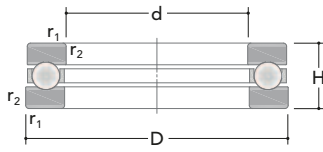

51M



Main dimensions			Basic load ratings		Speed ratings		Dimensions		Mass	Designation
d	D	H	Dynamic C	Static C ₀	Reference	Limiting	r _{1,2min}	r _{amax}		
[mm]			[kN]		[rpm]		[mm]		[Kg]	-
280	380	80	469	2300	720	850	2,1	2	26,5	51256
300	380	62	350	1740	810	990	2	2	17,5	51160
	420	95	573	2990	610	720	3	2,5	42	51260
320	360	30	110	731	860	1000	1	1	4,30	51064
	400	48	233	1290	670	800	2	2	13,50	59164
	400	63	358	1840	770	940	2	2	19	51164
	440	95	555	2970	580	660	3	2,5	45,5	51264
340	420	64	368	1950	780	950	2	2	20,5	51168
	460	96	586	3160	510	650	3	2,5	48,5	51268
	540	160	1010	5770	290	340	5	4	135,00	51368
360	400	30	115	811	810	1000	1	1	4,85	51072
	440	48	247	1490	640	780	2	2	15,00	59172
	440	65	378	2050	720	830	2	2	22	51172
	500	110	720	4110	480	580	4	3	70	51272
366	440	65	289	1450	540	620	1,1	1	19,50	634132
380	460	36	181	1130	730	830	2	2	12,50	351793
	460	48	248	1510	610	730	2	2	15,00	59176
	460	65	388	2190	730	840	2	2	23	51176
	520	112	709	4080	480	590	4	3	73	51276
	670	224	1600	10310	180	230	7,5	6	330,00	51476
385	510	110	594	3380	360	430	43	3	66,00	350550
400	480	48	254	1600	610	720	2	2	16,50	59180
	480	65	390	2250	670	840	2	2	24	51180
	540	112	738	4490	360	410	4	3	78,50	51280
415,2	544,9	125	890	5660	-	-	4,5	4	81,00	351955
420	500	48	255	1670	600	730	2	2	17,00	59184
	500	65	401	2390	680	830	2	2	25,5	51184
	580	130	860	5400	310	360	5	4	110,00	51284
440	520	65	292	1620	480	570	1,1	1	24,00	634131
	540	60	230	1490	510	580	2,1	2	28,00	59188

Main dimensions			Basic load ratings		Speed ratings		Dimensions		Mass	Designation
d	D	H	Dynamic C	Static C ₀	Reference	Limiting	r _{1,2min}	r _{amax}		
[mm]			[kN]		[rpm]		[mm]		[Kg]	–
440	540	80	507	3190	570	730	2,1	2	42	51188
	600	130	878	5590	310	360	5	4	115,00	51288
460	560	80	508	3230	570	660	2,1	2	43,5	51192
	620	130	888	5800	300	360	5	4	120,00	51292
480	580	80	520	3520	530	660	2,1	2	45,5	51196
	650	135	962	6460	290	330	5	4	130,00	51296
500	540	30	129	1110	720	830	1	1	6,55	510/500
	600	60	240	1620	480	570	2,1	2	32,00	591/500
	600	80	539	3580	540	670	2,1	2	47	511/500
	670	135	973	6750	260	310	5	4	135,00	512/500
522	600	40	275	2230	–	–	1,5	1,5	17,50	351796
530	580	38	199	1580	610	710	1,1	1	11,00	510/530
	590	36	171	1360	640	740	1	1	12,50	351794
	640	67	458	3110	440	520	1,5	2,5	43,50	591/530
	640	85	633	4370	510	630	3	2,5	58,5	511/530
560	610	38	195	1620	600	690	1,1	1	11,50	510/560
	670	67	451	3190	430	500	3	2,5	45,50	591/560
	670	85	626	4610	480	600	3	2,5	61	511/560
600	650	38	206	1790	580	670	1,1	1	12,00	510/600
	710	67	463	3380	430	500	3	2,5	48,00	591/600
	710	85	639	4720	480	590	3	2,5	65	511/600
	800	90	654	4930	320	380	5	4	117,00	350769
630	680	38	216	1900	580	670	1,1	1	12,50	510/630
	750	73	528	3990	390	440	3	2,5	62,50	591/630
	750	95	702	5310	430	510	3	2,5	84	511/630
670	730	45	276	2390	510	600	1,5	1,5	21,00	510/670
	800	75	527	4080	350	410	4	3	74,00	591/670
	800	105	827	6630	380	470	4	3	105	511/670
710	780	53	349	2800	430	510	1,5	1,5	28,00	510/710
	850	85	656	5390	320	380	4	3	88,50	591/710

Single direction thrust ball bearings

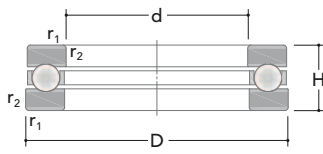

51M



Main dimensions			Basic load ratings		Speed ratings		Dimensions		Mass	Designation
d	D	H	Dynamic C	Static C ₀	Reference	Limiting	r _{1,2min}	r _{amax}		
[mm]			[kN]		[rpm]		[mm]		[Kg]	–
710	850	112	917	7640	270	320	4	3	130,00	511/710
730	850	85	640	5370	320	380	3	2,5	88,00	350627
750	820	53	351	3000	430	500	1,5	1,5	30,00	510/750
	900	90	717	6380	290	330	4	3	105,00	591/750
	900	120	980	8480	230	280	4	3	155,00	511/750
800	870	53	359	3160	410	460	1,5	1,5	32,50	510/800
	950	90	743	6450	290	340	4	3	110,00	591/800
	950	120	971	8920	230	280	4	3	155,00	511/800
850	920	53	367	3390	–	–	1,5	1,5	34,5	510/850
	1000	90	737	6790	–	–	4	3	115	591/850
	1000	120	1020	9460	–	–	4	3	165	511/850
900	980	63	513	4810	–	–	2	2	49	510/900
	1060	95	608	7530	–	–	5	4	140	591/900
	1060	130	1110	10790	–	–	5	4	205	511/900
950	1080	63	520	5000	–	–	2	2	52	510/950
	1120	103	834	8130	–	–	5	4	170	591/950
	1120	135	1280	11840	–	–	5	4	235	511/950
980	1120	120	980	9900	–	–	5	4	185	351883
1000	1090	70	560	5440	–	–	2,1	2	68,5	510/1000
	1180	109	886	9060	–	–	5	4	210	591/1000
	1180	140	1270	13070	–	–	5	4	275	511/1000
1060	1150	70	724	5740	–	–	2,1	2	72,5	510/1060
	1250	115	973	10330	–	–	5	4	240	591/1060
	1250	150	1370	14880	–	–	5	4	330	511/1060
1120	1320	160	1490	16250	–	–	5	4	395	511/1120
1180	1400	175	1720	19630	–	–	6	5	495	511/1180
1250	1500	150	1390	15970	–	–	6	5	515	351006 A
1380	1540	130	1290	16180	–	–	5	4	310	351890

Main dimensions			Basic load ratings		Speed ratings		Dimensions		Mass	Designation
d	D	H	Dynamic C	Static C ₀	Reference	Limiting	r _{1,2min}	r _{amax}		
[mm]			[kN]		[rpm]		[mm]		[Kg]	-
1400	1630	180	1830	23280	-	-	8	6	665	511/1400

Single direction thrust ball bearings

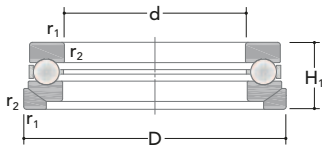

53M+U

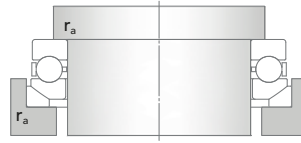

Main dimensions			Basic load ratings		Speed ratings		Dimensions		Mass	Designation	
d	D	H ₁	Dynamic C	Static C ₀	Reference	Limiting	r _{1,2min}	r _{amax}		Bearing	Seat washer
[mm]			[kN]		[rpm]		[mm]		[Kg]	-	
12	28	13	12,9	20,4	7700	9400	0,6	0,6	0,045	53201	U 201
15	32	15	15,5	24,7	6800	8500	0,6	0,6	0,063	53202	U 202
17	35	15	16,0	27,0	6500	8000	0,6	0,6	0,071	53203	U 203
20	40	17	20,5	37,0	5400	6600	0,6	0,6	0,1	53204	U 204
25	47	19	25,5	49,2	4800	5900	0,6	0,6	0,15	53205	U 205
30	52	20	24,5	50,7	4300	5400	0,6	0,6	0,18	53206	U 206
	60	25	34,6	65,3	3600	4500	1	1	0,33	53306	U 306
35	62	22	34,1	72,9	3800	4600	1	1	0,28	53207	U 207
	68	28	47,5	95,7	3000	3700	1	1	0,46	53307	U 307
40	68	23	43,3	96,5	3500	4500	1	1	0,35	53208	U 208
	78	31	60,0	121	2700	3200	1	1	0,67	53308	U 308
	90	42	92,6	181	2300	2600	1,1	1	1,35	53408	U 408
45	73	24	37,7	85,4	3200	4000	1	1	0,39	53209	U 209
	85	33	73,4	152	2500	3200	1	1	0,83	53309	U 309
50	78	26	48,2	114	3100	3800	1	1	0,47	53210	U 210
	95	37	79,8	169	2300	2800	1,1	1	1,2	53310	U 310
	110	50	155	1857	1800	2100	1,5	1,5	2,3	53410	U 410
55	90	30	57,2	132	2700	3100	1	1	0,75	53211	U 211
	105	42	98,7	223	2100	2400	1,1	1	1,7	53311	U 311
	120	55	190	398	1600	1900	1,5	1,5	3,1	53411	U 411
60	95	31	57,4	140	2500	3100	1	1	0,82	53212	U 212
	110	42	97,2	222	1900	2400	1,1	1	1,7	53312	U 312
	130	58	192	424	1500	1800	1,5	1	3,8	53412	U 412
65	100	32	58,7	149	2500	3000	1	1	0,91	53213	U 213
	115	43	103	240	1900	2400	1,1	1	1,9	53313	U 313
70	105	32	60,1	159	2500	3000	1	1	0,97	53214	U 214
	125	48	130	317	1700	2100	1,1	1	2,5	53314	U 314
	150	69	226	547	1300	1700	2	2	6,5	53414	U 414

Main dimensions			Basic load ratings		Speed ratings		Dimensions		Mass	Designation	
d	D	H ₁	Dynamic C	Static C ₀	Reference	Limiting	r _{1,2min}	r _{amax}		Bearing	Seat washer
[mm]			[kN]		[rpm]		[mm]		[Kg]	–	
75	110	32	61,3	167	2300	2800	1	1	1	53215	U 215
	135	52	158	382	1600	1900	1,5	1	3,2	53315	U 315
	160	75	244	599	1200	1500	2	2	8,1	53415	U 415
80	115	33	73,2	206	2300	2700	1	1	1,1	53216	U 216
	140	52	154	387	1500	1800	1,5	1	3,2	53316	U 316
85	125	37	94,8	270	1900	2400	1	1	1,5	53217	U 217
	150	58	169	397	1400	1600	1,5	1	4,35	53317	U 317
90	135	42	110	287	1800	2100	1,1	1	2,1	53218	U 218
	155	59	176	438	1300	1600	1,5	1	4,7	53318	U 318
	190	88	301	806	1000	1200	2,1	2	13	53418	U 418
100	150	45	115	324	1600	2000	1,1	1	2,7	53220	U 220
	170	64	220	562	1200	1500	1,5	1	5,95	53320	U 320
	210	98	360	1030	920	1000	3	2	18	53420	U 420
110	160	45	122	360	1600	2000	1,1	1	2,9	53222	U 222
	190	72	273	801	1000	1300	2	1	9,1	53322	U 322
120	170	46	124	385	1400	1800	1,1	1	3,2	53224	U 224
	210	80	314	977	960	1100	2,1	1	12,5	53324	U 324
130	190	53	182	585	1200	1400	1,5	1	4,85	53226	U 226
140	200	55	185	614	1200	1500	1,5	1	5,45	53228	U 228

Double direction thrust ball bearings

Double direction thrust ball bearings are composed of one shaft washers, two housing washers and two cage-balls assemblies. Bearings are separable so, washers and cage-balls assemblies can be mounted separately. Axial deep groove ball bearings of series 522, 523 that have flat housing washers, can support axial forces in both direction but they cannot withstand any radial load and any misalignment.

Bearings of series 542 and 543 can support axial force in both direction, but having a spherical housing washers and matched with seating washer U2 and U3, they are able to compensate a misalignment between shaft and housing. No radial load can be supported.

The main boundary dimensions of axial deep groove ball bearings with flat and sphered housing washers are in conformity with ISO 104:2015 and DIN 711:2010 and DIN 715:2011 (ISO 20516:2007), respectively. They are manufactured with tolerances according to ISO 199:2014.

Minimum load

A minimum axial load is requested for a thrust ball bearing, like for all ball and roller bearings, to operate correctly, especially in critical application requirements like: high speed, high acceleration and sudden changes of rotating direction. In these operating conditions a skidding between the balls and raceways can be generated by the inertial forces, influencing negatively the bearing life. To calculate the minimum axial load please consult the RKB application engineering service.



Designs and variants

Type 52M



HB
BAINITE HT

S
STABILIZATION

- Flat housing washers
- One-piece machined brass cage (M) guided on balls
- Separable design
- Supports medium to high bidirectional axial loads
- Suitable for applications requiring good limiting speeds

Double direction thrust ball bearings

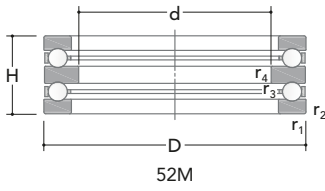

Main dimensions			Basic load ratings		Speed ratings		Dimensions				Mass	Designation
d	D	H	Dynamic C	Static C ₀	Reference	Limiting	r _{1,2min}	r _{3,4min}	r _{amax}	r _{bmax}		
[mm]			[kN]		[rpm]		[mm]				[kg]	–
10	32	22	15,6	24,7	6800	8400	0,6	0,3	0,6	0,3	0,081	52202
15	40	26	20,4	36,8	4100	5100	0,6	0,3	0,6	0,3	0,15	52204
20	47	28	25,7	49,5	3600	4500	0,6	0,3	0,6	0,3	0,22	52205
	52	34	33,5	59,5	3100	3800	1	0,3	1	0,3	0,33	52305
	70	52	68,1	121	2100	2600	1	0,6	1	0,6	1	52406
25	52	29	24,0	45,7	3500	4100	0,6	0,3	0,6	0,3	0,25	52206
	60	38	34,5	64,5	2700	3400	1	0,3	1	0,3	0,47	52306
	80	59	74,2	136	1900	2400	1,1	0,6	1	0,6	1,45	52407
30	62	34	34,1	72,9	2900	3500	1	0,3	1	0,3	0,41	52207
	68	36	43,1	95,1	2700	3100	1	0,6	1	0,6	0,55	52208
	68	44	47,4	95,5	2300	2800	1	0,3	1	0,3	0,68	52307
	78	49	59,6	121	2100	2500	1	0,6	1	0,6	1,05	52308
	90	65	92,1	180	1700	1900	1,1	0,6	1	0,6	2,05	52408
35	73	37	37,7	86,2	2500	3000	1	0,6	1	0,6	0,6	52209
	85	52	74,5	153	1900	2300	1	0,6	1	0,6	1,25	52309
	100	72	121	240	1500	1800	1,1	0,6	1	0,6	2,7	52409
40	78	39	47,9	115	2300	2900	1	0,6	1	0,6	0,71	52210
	95	58	79,1	169	1700	2100	1,1	0,6	1	0,6	1,75	52310
45	90	45	57,2	132	2100	2400	1	0,6	1	0,6	1,1	52211
	105	64	97,6	221	1500	1800	1,1	0,6	1	0,6	2,4	52311
	120	87	191	395	1200	1500	1,5	0,6	1,5	0,6	4,7	52411
50	95	46	57,0	138	1900	2300	1	0,6	1	0,6	1,2	52212
	110	64	98,9	222	1500	1800	1,1	0,6	1	0,6	2,55	52312
	130	93	192	428	1100	1400	1,5	0,6	1,5	0,6	6,35	52412
55	100	47	59,0	148	1900	2300	1	0,6	1	0,6	1,35	52213
	105	47	60,2	159	1800	2100	1	1	1	1	1,5	52214
	115	64	103	237	1500	1900	1,1	0,6	1	0,6	2,75	52313
	125	72	132	319	1300	1600	1,1	1	1	1	3,65	52314
	250	107	225	539	760	940	2	1	1,5	1	9,7	52414
60	110	47	62,3	168	1800	2200	1	1	1	1	1,55	52215
	135	79	159	384	1200	1500	1,5	1	1,5	1	4,8	52315

Main dimensions			Basic load ratings		Speed ratings		Dimensions				Mass	Designation
d	D	H	Dynamic C	Static C ₀	Reference	Limiting	r _{1,2min}	r _{3,4min}	r _{amax}	r _{bmax}		
[mm]			[kN]		[rpm]		[mm]				[kg]	-
65	115	48	73,4	207	2300	2800	1	1	1	1	1,7	52216
	140	79	153	387	1200	1500	1,5	1	1	1	4,95	52316
70	125	55	95,1	271	1500	1800	1	1	1	1	2,4	52217
75	135	62	109	285	1400	1600	1,1	1	1	1	3,2	52218
85	150	67	115	324	1200	1400	1,1	1	1	1	4,2	52220
	170	97	219	567	970	1100	1,5	1	1	1	8,95	52320
95	160	67	120	358	1200	1500	1,1	1	1	1	4,65	52222
100	170	68	123	386	1100	1400	1,1	1,1	1	1	5,25	52224
110	190	80	180	584	1300	1600	1,5	1,1	1,5	1	8	52226
120	200	81	185	611	970	1100	1,5	1,1	1,5	1	8,65	52228
130	215	89	230	789	910	1100	1,5	1,1	1,5	1	11,5	52230
140	225	90	231	829	870	1100	1,5	1,1	1,5	1	12	52232
	250	98	293	1110	770	940	1,5	2	1,5	2	16	52236

Cylindrical roller thrust bearings

The cylindrical roller thrust bearings manufactured by RKB are designed to support high axial loads (no radial loads are allowed on this kind of bearing). The manufacturing program includes single and double direction cylindrical roller thrust bearings with flat or spherical housing washers to meet any requirements in various industrial applications. Thanks to the improved internal geometry and the use of the most suitable raw materials, all RKB cylindrical roller thrust bearings attain the highest axial load ratings and the best reliability. Depending on application requirements, RKB Bainite Hardening Treatment (HB) and High Temperature Dimensional Stabilization (S) can be applied on bearing rings and rolling elements. The bearing dimensional and running accuracy conforms to ISO/ABMA/GOST specifications.



Single direction cylindrical roller thrust bearing

Single direction cylindrical roller thrust bearings

Single direction cylindrical roller thrust bearings are composed of a housing washers GS, shaft washers WS and cage-cylindrical rollers assembly. Bearings are separable so, washers and cage-cylindrical rollers assembly can be mounted separately. These bearings are characterized by a very low axial section, high load capacity and high stiffness. They can support only axial loads in one direction and are not available to support radial force and tilting moments. Axial cylindrical roller bearings of series 811 and 812 are single row bearings while the bearings of series 893 and 894 are double row bearings and their presence is required for heavy loads. Shaft washers WS are centered on the shaft while housing washers are centered in the housing. Both washers have a bore diameter, outer diameter and rolling surface precision machined.

Misalignment

Cylindrical roller thrust bearings do not allow any misalignment between shaft and housing and any alignment errors between support surfaces in the housing and on the shaft.

Minimum load

A minimum axial load is requested for a cylindrical roller thrust bearing bearing, like for all ball and roller bearings, to operate correctly, especially in critical application requirements like: high speed, high acceleration and sudden changes of rotating direction. In these operating conditions a skidding between the cylindrical rollers and raceways can be generated by the inertial forces, influencing negatively the bearing life. To calculate the minimum axial load please consult the RKB application engineering service.

However, the minimum axial load is reached or surpassed by the weight of the components supported by the bearing, mostly when the shaft is vertical and the loads acting on it. If the minimum axial load is not reached or in case of application where a starting up at low temperature is planned or a lubricant with high viscosity is used, it will be necessary to preload the thrust cylindrical bearings by springs or shaft nut.

For additional information, please consult the RKB application engineering service.

Single direction cylindrical roller thrust bearings

Designs and variants

Type 81M

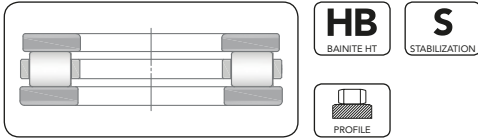

- Flat housing locating washer
- Low cross section separable design
- Two-piece machined brass cage (M) guided on rollers
- Supports unidirectional axial loads

Type 81M+U

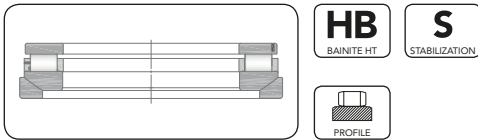

- Sphered housing washer
- Low cross section separable design
- Two-piece machined brass cage (M) guided on rollers
- Supports unidirectional axial loads
- The sphered housing washer is mounted on a locating sphered seating washer to accommodate shaft misalignment

Type 89M

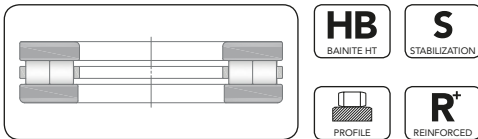

- Flat housing locating washer
- Two rows of rollers
- Two-piece machined brass cage (M) guided on rollers
- Low cross section separable design
- Supports unidirectional axial loads

Prefixes

T	Single direction cylindrical roller thrust bearing followed by size indication
AT	Self-aligning single direction cylindrical roller thrust bearing followed by size indication
GS	Housing washer
WS	Shaft washer
K	Cylindrical roller and cage thrust assembly

Suffixes
Internal design

SP	Special or non-standard bearing
----	---------------------------------

Suffixes
Cage

M	Machined brass cage guided on rollers
TN or ATN	Molded polyamide cage (PA66) guided on rollers
TN9	Molded glass fiber-reinforced polyamide cage (PA66-GF25) guided on rollers

Suffixes
Accuracy, clearance, running

P6S	Dimensional and running accuracy between P6 and P5
-----	--

Prefixes
Alternative designation

TCRB	Out of standard single direction cylindrical roller thrust bearing followed by drawing number
TTCRB	Out of standard double direction cylindrical roller thrust bearing followed by drawing number
TCRBU	Out of standard single direction cylindrical roller thrust bearing with sphered housing washer followed by drawing number

Single direction cylindrical roller thrust bearings

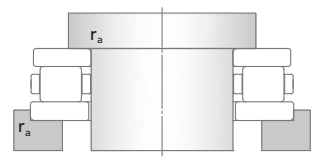
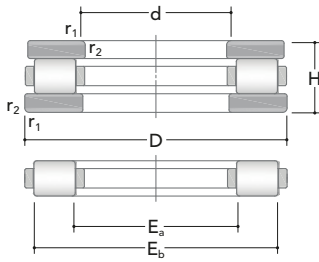

81M

Main dimensions					Basic load ratings		Speed ratings		Dimensions		Mass	Designation	Designation of components			
d	D	H	E _a	E _b	Dynamic C	Static C ₀	Reference	Limiting	r _{1,2min}	r _{amax}			Cylindrical roller and cage thrust assembly	Shaft washer	Housing washer	Univul washer
[mm]					[kN]		[rpm]		[mm]		[Kg]					
15	28	9	16	27	10,9	26,7	4100	7000	0,3	0,3	0,024	81102	K 81102	WS 81102	GS 81102	LS 1528
17	30	9	18	29	11,8	31,0	4100	7000	0,3	0,3	0,027	81103	K 81103	WS 81103	GS 81103	LS 1730
20	35	10	21	34	18,0	47,3	3600	6400	0,3	0,3	0,037	81104	K 81104	WS 81104	GS 81104	LS 2035
25	42	11	26	41	24,0	68,2	3000	5300	0,6	0,6	0,053	81105	K 81105	WS 81105	GS 81105	LS 2542
30	47	11	31	46	26,4	77,7	2900	5100	0,6	0,6	0,057	81106	K 81106	WS 81106	GS 81106	LS 3047
	52	16	31	50	48,3	132	2300	4100	0,6	0,6	0,12	81206	K 81206	WS 81206	GS 81206	-
	60	18	33	59	50,2	182	2500	4400	1	1	0,24	89306	K 89306	WS 89306	GS 89306	-
35	52	12	36	51	28,4	93,0	2700	4800	0,6	0,6	0,073	81107	K 81107	WS 81107	GS 81107	LS 3552
	62	18	39	58	60,0	188	1900	3400	1	1	0,21	81207	K 81207	WS 81207	GS 81207	-
	68	20	38	67	60,6	219	2300	4100	1	1	0,34	89307	K 89307	WS 89307	GS 89307	-
40	60	13	42	58	41,7	136	2300	4100	0,6	0,6	0,11	81108	K 81108	WS 81108	GS 81108	LS 4060
	68	19	43	66	81,2	252	1800	3200	1	1	0,25	81208	K 81208	WS 81208	GS 81208	-
	78	22	44	77	92,0	361	1900	3300	1	1	0,48	89308	K 89308	WS 89308	GS 89308	-
45	65	14	47	63	43,7	150	2100	3800	0,6	0,6	0,13	81109	K 81109	WS 81109	GS 81109	LS 4565
	73	20	48	70	80,1	254	1700	2900	1	1	0,29	81209	K 81209	WS 81209	GS 81209	-
	85	24	49	83	105	422	1700	3000	1	1	0,62	89309	K 89309	WS 89309	GS 89309	-
50	70	14	52	68	45,7	163	2100	3700	0,6	0,6	0,14	81110	K 81110	WS 81110	GS 81110	LS 5070
	78	22	53	75	89,4	299	1600	2800	1	1	0,36	81210	K 81210	WS 81210	GS 81210	-
	95	27	56	92	127	526	1500	2600	1,1	1,1	0,89	89310	K 89310	WS 89310	GS 89310	-
55	78	16	57	77	67,8	284	1800	3200	0,6	0,6	0,23	81111	K 81111	WS 81111	GS 81111	LS 5578
	90	25	59	85	118	386	1300	2300	1	1	0,57	81211	K 81211	WS 81211	GS 81211	-
	105	30	61	103	138	566	1400	2400	1,1	1,1	1,2	89311	K 89311	WS 89311	GS 89311	-
60	85	17	62	82	77,7	294	1700	3000	1	1	0,27	81112	K 81112	WS 81112	GS 81112	LS 6085
	95	26	64	91	134	463	1300	2300	1	1	0,65	81212	K 81212	WS 81212	GS 81212	-
	110	30	66	108	150	633	1300	2300	1,1	1,1	1,25	89312	K 89312	WS 89312	GS 89312	-
	130	42	65	126	302	1160	1100	2000	1,5	1,5	2,8	89412	K 89412	WS 89412	GS 89412	-
65	90	18	67	87	80,7	317	1600	2800	1	1	0,31	81113	K 81113	WS 81113	GS 81113	LS 6590
	100	27	69	96	137	483	1200	2200	1	1	0,72	81213	K 81213	WS 81213	GS 81213	-
	115	30	71	113	150	639	1300	2400	1,1	1,1	1,35	89313	K 89313	WS 89313	GS 89313	-
	140	45	70	135	345	1340	1000	1800	2	2	3,5	89413	K 89413	WS 89413	GS 89413	-



81M+U



89M

Main dimensions					Basic load ratings		Speed ratings		Dimensions		Mass	Designation	Designation of components			
d	D	H	E _a	E _b	Dynamic C	Static C ₀	Reference	Limiting	r _{1,2min}	r _{amax}			Cylindrical roller and cage thrust assembly	Shaft washer	Housing washer	Universal washer
[mm]					[kN]		[rpm]		[mm]		[Kg]					
70	95	18	72	92	84,3	340	1600	2800	1	1	0,33	81114	K 81114	WS 81114	GS 81114	LS 7095
	105	27	74	102	142	525	1200	2200	1	1	0,77	81214	K 81214	WS 81214	GS 81214	-
	125	34	76	123	180	798	1200	2100	1,1	1,1	1,8	89314	K 89314	WS 89314	GS 89314	-
	150	48	76	147	372	1440	970	1700	2	2	4,2	89414	K 89414	WS 89414	GS 89414	-
75	100	19	78	97	79,7	328	1500	2600	1	1	0,39	81115	K 81115	WS 81115	GS 81115	LS 75100
	110	27	79	106	133	484	1100	2000	1	1	0,8	81215	K 81215	WS 81215	GS 81215	-
	135	36	81	132	219	946	1100	1900	1,5	1,5	2,25	89315	K 89315	WS 89315	GS 89315	-
	160	51	82	156	390	1520	920	1500	2	2	5,95	89415	K 89415	WS 89415	GS 89415	-
80	105	19	83	102	78,8	331	1400	2500	1	1	0,4	81116	K 81116	WS 81116	GS 81116	LS 80105
	115	28	84	112	157	603	1100	2000	1	1	0,9	81216	K 81216	WS 81216	GS 81216	-
	140	36	86	137	233	1050	1100	1900	1,5	1,5	2,35	89316	K 89316	WS 89316	GS 89316	-
	170	54	88	165	427	1720	870	1500	2,1	2,1	7,05	89416	K 89416	WS 89416	GS 89416	-
85	110	19	87	108	86,0	360	1400	2500	1	1	0,42	81117	K 81117	WS 81117	GS 81117	LS 85110
	125	31	90	119	165	639	1000	1800	1	1	1,2	81217	K 81217	WS 81217	GS 81217	-
	150	39	93	146	248	1080	1000	1800	1,5	1,5	3,4	89317	K 89317	WS 89317	GS 89317	-
	180	58	93	175	472	1910	810	1400	2,1	2,1	8,65	89417	K 89417	WS 89417	GS 89417	-
90	120	22	93	117	107	445	1260	2230	1	1	0,62	81118	K 81118	WS 81118	GS 81118	LS 90120
	135	35	95	129	225	855	960	1690	1,1	1,1	1,75	81218	K 81218	WS 81218	GS 81218	-
	155	39	98	151	257	1140	970	1640	1,5	1,5	3,65	89318	K 89318	WS 89318	GS 89318	-
	190	60	99	185	528	2090	780	1320	2,1	2,1	9,95	89418	K 89418	WS 89418	GS 89418	-
100	135	25	104	131	150	619	1150	2020	1	1	0,95	81120	K 81120	WS 81120	GS 81120	LS 100135
	150	38	107	142	260	1040	860	1490	1,1	1,1	2,2	81220	K 81220	WS 81220	GS 81220	-
	170	42	109	166	291	1350	920	1590	1,5	1,5	4,55	89320	K 89320	WS 89320	GS 89320	-
	210	67	111	205	656	2780	670	1180	3	3	13,5	89420	K 89420	WS 89420	GS 89420	-
110	145	25	114	141	157	676	1060	1810	1	1	1,05	81122	K 81122	WS 81122	GS 81122	LS 110145
	160	38	117	152	252	988	820	1420	1,1	1,1	2,3	81222	K 81222	WS 81222	GS 81222	-
	190	48	120	185	388	1810	820	1460	2	2	6,7	89322	K 89322	WS 89322	GS 89322	-
	230	73	121	223	771	3320	600	1100	3	3	17,5	89422	K 89422	WS 89422	GS 89422	-
120	155	25	124	151	166	731	1070	1830	1	1	1,1	81124	K 81124	WS 81124	GS 81124	LS 120155
	170	39	127	162	246	986	770	1380	1,1	1,1	2,55	81224	K 81224	WS 81224	GS 81224	-
	210	54	132	205	500	2350	730	1280	2,1	2,1	9,45	89324	K 89324	WS 89324	GS 89324	-
	250	78	133	243	896	3870	570	1030	4	4	22	89424	K 89424	WS 89424	GS 89424	-
130	170	30	135	165	196	869	920	1590	1	1	1,65	81126	K 81126	WS 81126	GS 81126	LS 130170

Single direction cylindrical roller thrust bearings

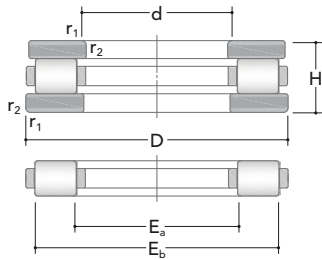

81M

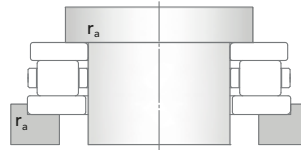

Main dimensions					Basic load ratings		Speed ratings		Dimensions		Mass	Designation	Designation of components			
d	D	H	E _a	E _b	Dynamic C	Static C ₀	Reference	Limiting	r _{1,2min}	r _{amax}			Cylindrical roller and cage thrust assembly	Shaft washer	Housing washer	Universal washer
[mm]					[kN]		[rpm]		[mm]		[Kg]					
130	190	45	137	181	367	1430	670	1210	1,5	1,5	4	81226	K 81226	WS 81226	GS 81226	-
	225	58	141	219	541	2610	670	1170	2,1	2,1	11	89326	K 89326	WS 89326	GS 89326	-
	270	85	145	263	1020	4480	510	940	4	4	27	89426	K 89426	WS 89426	GS 89426	-
140	180	31	145	175	202	914	870	1510	1	1	1,9	81128	K 81128	WS 81128	GS 81128	LS 140180
	200	46	150	191	348	1370	670	1160	1,5	1,5	5,05	81228	K 81228	WS 81228	GS 81228	-
	240	60	152	234	622	3070	650	1080	2,1	2,1	12,5	89328	K 89328	WS 89328	GS 89328	-
	280	85	155	273	1070	4740	510	910	4	4	29,5	89428	K 89428	WS 89428	GS 89428	-
150	190	31	155	185	206	990	820	1390	1	1	2,2	81130	K 81130	WS 81130	GS 81130	LS 150190
	215	50	162	210	453	1870	610	1070	1,5	1,5	7,2	81230	K 81230	WS 81230	GS 81230	-
	250	60	162	244	646	3200	600	1070	2,1	2,1	14	89330	K 89330	WS 89330	GS 89330	-
	300	90	167	293	1210	5570	480	820	4	4	35,5	89430	K 89430	WS 89430	GS 89430	-
160	200	31	165	195	211	1000	820	1430	1	1	2,1	81132	K 81132	WS 81132	GS 81132	LS 160200
	225	51	171	219	467	1980	580	998	1,5	1,5	7,6	81232	K 81232	WS 81232	GS 81232	-
	320	95	179	313	1370	6270	460	790	5	5	42	89432	K 89432	WS 89432	GS 89432	-
170	215	34	176	209	275	1320	770	1330	1,1	1,1	2,4	81134	K 81134	WS 81134	GS 81134	-
	240	55	184	233	528	2270	540	940	1,5	1,5	9,3	81234	K 81234	WS 81234	GS 81234	-
	340	103	191	333	1550	7120	410	720	5	5	52	89434	K 89434	WS 89434	GS 89434	-
180	225	34	185	219	261	1250	720	1280	1,1	1,1	3,7	81136	K 81136	WS 81136	GS 81136	-
	250	56	194	243	537	2390	540	900	1,5	1,5	9,95	81236	K 81236	WS 81236	GS 81236	-
	360	109	200	351	1710	7880	390	690	5	5	60	89436	K 89436	WS 89436	GS 89436	-
190	240	37	197	233	301	1430	670	1140	1,1	1,1	4,75	81138	K 81138	WS 81138	GS 81138	-
	270	62	205	263	678	2850	480	850	2	2	12	81238	K 81238	WS 81238	GS 81238	-
	380	115	212	371	1890	8880	360	620	5	5	65,5	89438	K 89438	WS 89438	GS 89438	-
200	250	37	206	243	300	1480	670	1200	1,1	1,1	4,95	81140	K 81140	WS 81140	GS 81140	-
	280	62	215	273	696	3080	480	820	2	2	13,5	81240	K 81240	WS 81240	GS 81240	-
	400	122	224	391	2100	9830	350	580	5	5	75	89440	K 89440	WS 89440	GS 89440	-
220	270	37	226	263	326	1680	650	1070	1,1	1,1	5,2	81144	K 81144	WS 81144	GS 81144	-
	300	63	236	294	724	3330	460	820	2	2	15	81244	K 81244	WS 81244	GS 81244	-
	420	122	244	411	2250	10980	320	580	6	6	84,5	89444	K 89444	WS 89444	GS 89444	-
240	300	45	248	296	462	2430	540	940	1,5	1,5	8,45	81148	K 81148	WS 81148	GS 81148	-
	340	78	263	333	1060	4880	380	690	2,1	2,1	22	81248	K 81248	WS 81248	GS 81248	-



81M+U



89M

Main dimensions					Basic load ratings		Speed ratings		Dimensions		Mass	Designation	Designation of components			
d	D	H	E _a	E _b	Dynamic C	Static C ₀	Reference	Limiting	r _{1,2min}	r _{amax}			Cylindrical roller and cage thrust assembly	Shaft washer	Housing washer	Univesal washer
[mm]					[kN]		[rpm]		[mm]		[Kg]	-				
260	320	45	268	316	477	2550	510	930	1,5	1,5	9,1	81152	K 81152	WS 81152	GS 81152	-
	360	79	281	351	1100	5250	360	630	2,1	2,1	27	81252	K 81252	WS 81252	GS 81252	-
280	350	53	288	346	656	3490	460	810	1,5	1,5	12,5	81156	K 81156	WS 81156	GS 81156	-
	380	80	301	371	1120	5390	340	610	2,1	2,1	30	81256	K 81256	WS 81256	GS 81256	-
300	380	62	315	373	816	4350	410	690	2	2	19,5	81160	K 81160	WS 81160	GS 81160	-
	420	95	329	412	1480	7100	300	530	3	3	43	81260	K 81260	WS 81260	GS 81260	-
320	400	63	334	394	855	4560	380	650	2	2	20,5	81164	K 81164	WS 81164	GS 81164	-
	440	95	348	434	1500	7450	280	500	3	2,5	42,5	81264	-	-	-	-
340	420	64	354	414	872	4840	360	670	2	2	22,5	81168	K 81168	WS 81168	GS 81168	-
	460	96	367	452	1560	7850	280	490	3	2,5	47	81268	-	-	-	-
360	440	65	374	434	875	4860	360	620	2	2	19,5	81172	-	-	-	-
	500	110	393	492	2110	10280	250	450	4	3	65,5	81272	-	-	-	-
380	460	65	393	453	909	5280	350	620	2	2	22	81176	-	-	-	-
400	480	65	413	473	934	5530	340	580	2	2	23	81180	-	-	-	-
420	500	65	433	493	946	5820	320	580	2	2	24	81184	-	-	-	-
440	540	80	459	533	1370	7870	280	500	2,1	2	39,5	81188	-	-	-	-
460	560	80	479	553	1410	8460	280	490	2,1	2	41	81192	-	-	-	-
480	580	80	500	573	1410	8530	270	460	2,1	2	43	81196	-	-	-	-
500	600	80	519	592	1490	9110	260	470	2,1	2	44	811/500	-	-	-	-
530	640	85	554	632	1680	10450	250	450	3	2,5	55,5	811/530	-	-	-	-
560	670	85	584	662	1710	10910	250	420	3	2,5	58	811/560	-	-	-	-
600	710	85	624	702	1760	11590	230	410	3	2,5	62	811/600	-	-	-	-
630	750	73			1590	11190	160	200	3	2,5	62	891/630				
	750	95	650	732	2080	13630	210	370	3	2,5	80	811/630	-	-	-	-
	850	175			4680	25650	93	110	6	5	295	812/630				

Single direction cylindrical roller thrust bearings

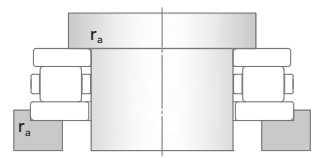
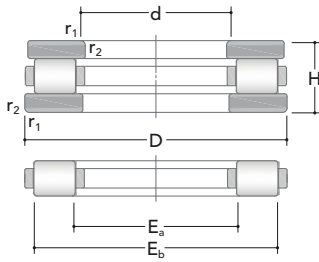

81M

Main dimensions			Basic load ratings		Speed ratings		Dimensions		Mass	Designation	Designation of components			
d	D	H	Dynamic C	Static C ₀	Reference	Limiting	r _{1,2min}	r _{amax}			Cylindrical roller and cage thrust assembly	Shaft washer	Housing washer	Universal washer
[mm]			[kN]		[rpm]		[mm]		[Kg]					
650	920	140	5190	37680	100	130	6	5	325	358130	-	-	-	-
	930	130	5270	37460	100	130	4	3	315	358162	-	-	-	-
655	765	45	1150	8950	190	250	1,9	1,5	39	634147	-	-	-	-
670	800	78	1930	13380	150	180	4	3	75,5	891/670	-	-	-	-
	800	105	2450	16160	140	160	4	3	110	811/670	-	-	-	-
	900	180	5490	30320	92	120	6	5	335	812/670	-	-	-	-
673,227	876,173	111,125	3890	25540	140	160	4	3	185	464790	-	-	-	-
710	850	85	2130	14860	140	160	4	3	95	891/710	-	-	-	-
	850	112	2800	18060	130	160	4	3	155	811/710	-	-	-	-
	950	190	5650	31580	87	100	6	5	395	812/710	-	-	-	-
711,327	964,26	127,127	5050	35340	130	160	7,6	7	300	475623	-	-	-	-
750	900	90	2340	16530	130	150	4	3	115	891/750	-	-	-	-
	900	120	3160	21040	110	140	4	3	155	811/750	-	-	-	-
	1000	195	6300	35370	82	99	6	5	445	812/750	-	-	-	-
762,127	964,946	111,125	4180	28530	120	150	4	3	210	464789	-	-	-	-
780	890	50	1180	9830	170	210	1,5	1,5	52	634055	-	-	-	-
800	950	90	2410	17750	130	160	4	3	120	891/800	-	-	-	-
	950	120	3340	21770	110	140	4	3	165	811/800	-	-	-	-
	1060	205	7200	40490	78	93	7,5	6	515	812/800	-	-	-	-
812,8	1016	127,127	5140	33680	100	130	2,3	2	250	464973	-	-	-	-
850	1000	90	2520	18840	120	150	4	3	130	891/850	-	-	-	-
	1000	120	3370	22910	100	130	4	3	170	811/850	-	-	-	-
	1120	212	7910	45100	78	95	7,5	6	580	812/850	-	-	-	-
900	1060	95	2960	21850	110	140	5	4	150	891/900	-	-	-	-
	1060	130	3870	26950	97	120	5	4	210	811/900	-	-	-	-
	1180	220	8300	48380	73	84	7,5	6	665	812/900	-	-	-	-
950	1120	103	3320	24810	100	130	5	4	185	891/950	-	-	-	-
	1120	135	4220	29700	91	110	5	4	250	811/950	-	-	-	-

81M+U

89M

Main dimensions			Basic load ratings		Speed ratings		Dimensions		Mass	Designation	Designation of components			
d	D	H	Dynamic C	Static C ₀	Reference	Limiting	r _{1,2min}	r _{amax}			Cylindrical roller and cage thrust assembly	Shaft washer	Housing washer	Univesal washer
[mm]			[kN]		[rpm]		[mm]		[Kg]					
950	1250	236	9770	57740	65	76	7,5	6	805	812/950	-	-	-	-
980	1120	120	3130	21770	-	-	5	4	180	358272	-	-	-	-
1000	1090	70	1780	15100	-	-	2,1	2	68	351585	-	-	-	-
	1120	52	1560	13810	-	-	2,1	2	75	634146	-	-	-	-
	1180	109	3800	28340	-	-	5	4	220	891/1000	-	-	-	-
	1160	140	4600	32470	-	-	5	4	285	811/1000	-	-	-	-
	1320	250	9990	59380	-	-	9,5	8	965	812/1000	-	-	-	-
1003,35	1117,6	50,8	1900	18290	-	-	2	2	64,5	358391	-	-	-	-
1060	1250	115	4000	30520	-	-	5	4	260	891/1060	-	-	-	-
	1250	150	5140	36130	-	-	5	4	225	811/1060	-	-	-	-
	1400	265	11620	70210	-	-	9,5	8	1150	812/1060	-	-	-	-
1120	1320	122	4840	36390	-	-	5	4	305	891/1120	-	-	-	-
	1320	160	5760	40720	-	-	5	4	410	811/1120	-	-	-	-
1200	1660	300	20040	124900	-	-	6	5	2140	358235	-	-	-	-
1280	1400	60	1650	18880	-	-	3	2,5	102	634152	-	-	-	-
1400	1520	52	1760	23240	-	-	2	2	97	358156	-	-	-	-
	1640	150	5950	47800	-	-	6	5	575	358316	-	-	-	-
1560	1650	57	739	8030	-	-	2	2	97	358395	-	-	-	-
1680	1800	75	2050	23580	-	-	4	3	175	634150	-	-	-	-
1750	1895	76	3070	41120	-	-	3	2,5	215	358157	-	-	-	-
2130	2250	76	2260	10070	-	-	3	2,5	235	634099	-	-	-	-
2305	2450	76	3660	53920	-	-	3	2,5	285	358158	-	-	-	-
2540	2700	80	4260	62730	-	-	3	2,5	365	358155	-	-	-	-

Double direction cylindrical roller thrust bearings

Double direction cylindrical roller thrust bearings are composed of two housing washers GS, one shaft washers WS and two cage-cylindrical rollers assemblies. Bearings are separable so washers and axial cylindrical roller and cage-cylindrical rollers assemblies can be mounted separately to ease the operations. These bearings are characterized by a very high load capacity and high stiffness. They can support axial loads in both direction and are not able to withstand radial force and tilting moments.

The main boundary dimensions of axial cylindrical roller bearings are in conformity with ISO 104:2015. They are manufactured with tolerances according to ISO 199:2014.



Double direction cylindrical roller thrust bearings

Misalignment

Thrust roller bearings do not allow any misalignment between shaft and housing and any alignment errors between support surfaces in the housing and on the shaft.

Minimum load

A minimum axial load is requested for a thrust roller bearing, like for all roller bearings, to operate correctly, especially in particularly application requirements like: high speed, high acceleration and sudden changes of direction. In these operating conditions a sliding movement between the rollers and raceways can be generated by the inertial forces, influencing negatively the bearing life. To calculate the minimum axial load please consult the RKB application engineering service.

However, the minimum axial load is reached or surpassed by the weight of the components supported by the bearing, mostly when the shaft is vertical and the loads acting on it. If the minimum axial load is not reached or in case of application where a starting up at low temperature is planned or a lubricant with high viscosity is used, it will be necessary to preload the cylindrical roller thrust bearings by springs or shaft nut.

Designs and variants

Type WS+GS

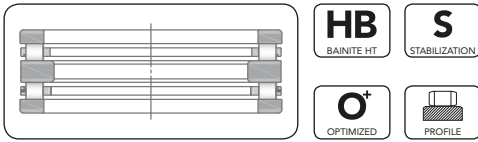

- Flat housing washers
- Separable components unit: shaft washers (WS) plus housing washers (GS)
- Two-piece machined brass cage (M) guided on rollers
- Sensitive to misalignments
- Supports very high bidirectional axial loads

Tapered roller thrust bearings

The tapered roller thrust bearings manufactured by RKB are designed to support very high axial loads and even moderate shock loads. Their particular design features a true rolling motion, minimizing roller friction and allowing a better running compared to other thrust bearings. According to this feature, tapered roller thrust bearings meet any requirements in various industrial applications. Thanks to the improved internal geometry and the use of the most suitable raw materials, all RKB TBs attain the highest axial load ratings and the best reliability. Depending on application requirements, RKB Bainite Hardening Treatment (HB) and High Temperature Dimensional Stabilization (S) can be applied on bearing rings and rolling elements. The bearing dimensional and running accuracy conforms to ISO/ ABMA/ GOST specifications.



Single direction tapered roller thrust bearings

Single direction tapered roller thrust bearings

Single direction tapered roller thrust bearings are produced in three different designs. The first one features a shaft washer with a tapered raceway, a two-piece machined brass cage, one row of tapered rollers and a flat housing washer. They have a separable design so, washers and cage-tapered roller assembly can be mounted separately. They can accommodate axial forces only in one direction and are able to accept a small eccentricity between shaft and housing without compromising their performances.

The second design has two identical tapered washers and a two-piece machined brass cage. It has a separable design so, washers and cage-tapered roller assembly can be mounted separately. This configuration is normally suggested where very heavy axial loads acting only in one direction have to be supported. On request for an increased carrying capacity, a full complement (cageless design) can be manufactured.

Bearing TKSD design for screw down mechanism is subjected to extremely heavy axial loads in one direction and, in order to maximize the load carrying capacity, this kind of bearing is normally full complement (cageless). Moreover, they have to be able to permit angular movement of the screw spindle respect to the support without affect negatively the bearing life. The angular movement may be accommodated by one sphered washer, that can be either shaft washer or housing washer. The pressure plate can be supplied by RKB.

Misalignment

Tapered roller thrust bearings do not allow any misalignment between shaft and housing and any alignment errors between support surfaces in the housing and on the shaft.

Minimum load

A minimum axial load is requested for a tapered roller thrust bearing, like for all roller bearings, to operate correctly, especially in particularly application requirements like: high speed, high acceleration and sudden changes of direction. In these operating conditions a sliding movement between the rollers and raceways can be generated by the inertial forces, influencing negatively the bearing life. To calculate the minimum axial load please consult the RKB application engineering service.

However, the minimum axial load is reached or surpassed by the weight of the components supported by the bearing, mostly when the shaft is vertical and the loads acting on it. If the minimum axial load is not reached or in case of application where a starting up at low temperature is planned or a lubricant with high viscosity is used, it will be necessary to preload the tapered roller thrust bearings by springs or shaft nut.

Single direction tapered roller thrust bearings

Designs and variants

Type TK₁

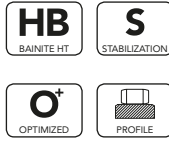
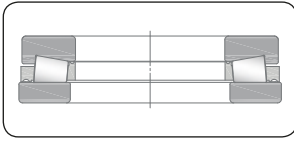

- Support unidirectional axial loads
- Tapered raceway on shaft washer and flat on housing washer
- Cage guided on both washers
- Optimized roller profile

Type TK₂

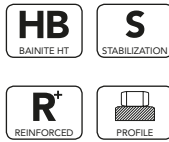

- Support unidirectional axial loads
- Cage guided on washers
- Symmetrical washers featuring taper raceway
- Optimized roller profile

Type TK₃

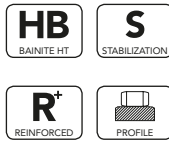
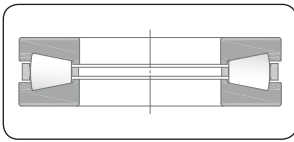

- Support unidirectional axial loads
- Cage guided on rollers
- Symmetrical washers featuring taper raceway
- Optimized roller profile

Type TK₄

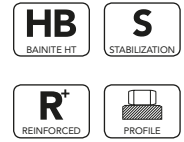
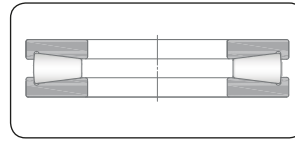

- Full complement (cageless) design for increased carrying capacities
- Support unidirectional axial loads
- Symmetrical washers featuring taper raceway
- Optimized roller profile

Type TKSD₁

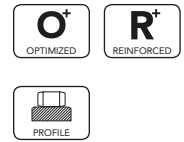
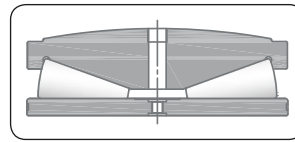

- Full complement (cageless) design, conceived for extremely high axial loads
- Special execution for screw-down mechanism
- Convex sphered shaft washer outer surface (suitable for concave screw spindles)
- Designed to accommodate misalignment angle on the sphered surface
- Optimized roller profile

Type TKSD₂

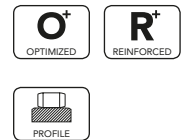
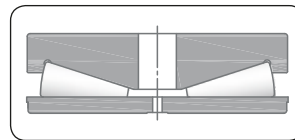

- Full complement (cageless) design, conceived for extremely high axial loads
- Special execution for screw-down mechanism
- Flat shaft washer outer surface
- No misalignment angle can be

accommodated

- Optimized roller profile

Type TKSD₃

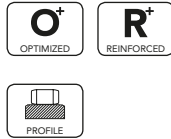
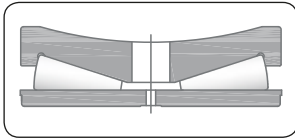

- Full complement (cageless) design, conceived for extremely high axial loads
- Special execution for screw-down mechanism
- Concave sphered shaft washer outer surface (suitable for convex screw spindles)
- Designed to accommodate misalignment angle on the sphered surface
- Optimized roller profile

Type TKSD₄

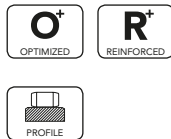
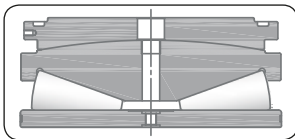

- Full complement (cageless) design, conceived for extremely high axial loads
- Special execution for screw-down mechanism
- Convex sphered shaft washer outer surface, mating a concave sphered pressure plate surface
- Designed to accommodate misalignment angle
- Optimized roller profile

Type TKSD₅

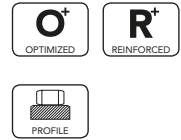
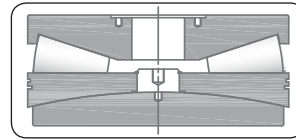

- Full complement (cageless) design, conceived for extremely high axial loads
- Special execution for screw-down mechanism
- Concave sphered housing washer outer surface, mating a convex sphered pressure plate surface
- Designed to accommodate misalignment angle
- Optimized roller profile

Single direction tapered roller thrust bearings

Suffixes	Internal design
ZB	Optimized roller profile for improved load distribution. It is not necessarily stated in the bearing code

Prefixes	Designazioni alternative
TK	Out of standard single direction tapered roller thrust bearing followed by drawing number
TKFL	Out of standard single direction tapered roller thrust bearing with flat shaft washer followed by drawing number
TTK	Out of standard double direction tapered roller thrust bearing followed by drawing number
TKSD	Out of standard screw-down bearing followed by drawing number

Single direction tapered roller thrust bearings

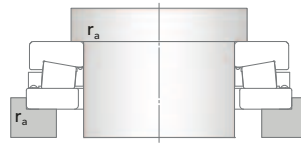
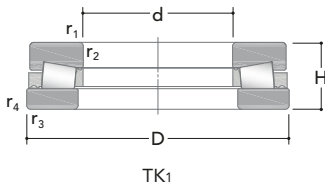

Main dimensions			Basic load ratings		Dimensions			Mass	Designation
d	D	H	Dynamic C	Static C ₀	r _{1,2min}	r _{3,4min}	r _{amax}		
[mm]			[kN]		[mm]			[Kg]	—
100	260	65	1100	4700	4	4	3	20,5	351137
120	300	75	1430	6280	5	5	3	33,5	351139
	300	79	2020	6570	4,8	4,8	4	30	353332
140	230	75	602	1860	2,1	2,1	2	14,5	350726
177,8	368,3	82,55	2350	10200	8	8	6	47	353286
180	500	145	5350	25300	6	6	5	195	353022
190	330	77	1430	5770	3,3	3,3	3	30	353348
220	500	125	3440	15700	7,5	7,5	6	160	351148
260	580	145	4540	21000	7,5	7,5	6	210	351153
279,4	603,25	136,525	7040	28400	4,8	4,8	4	205	353316
290	400	73	1030	4630	3	3	2,5	32,5	350888
300	660	165	5800	26600	7,5	7,5	6	350	351195
	660	165	6360	27800	10	10	9	315	353916
340	460	73	1190	5660	3	3	2,5	37	350565
347,5	710	160	7510	39200	4	4	3	345	351468
370	560	115	3410	14100	5	5	4	110	353205
380	560	110	2800	11900	3	3	2,5	110	353164
480	730	112	3450	18800	6	6	5	180	350998
558,8	1066,8	285,75	19000	73700	12,7	—	12	1200	353285
600	900	170	6800	32000	7,5	7,5	6	405	353201
749,3	952,5	127	5680	29800	5	2,5	4	230	353247
840	1140	195	10900	63100	7,5	7,5	6	575	351573



TK2

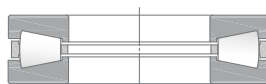

TK3



TK4

Main dimensions			Basic load ratings		Dimensions			Mass	Designation
d	D	H	Dynamic C	Static C ₀	r _{1,2min}	r _{3,4min}	r _{amax}		
[mm]			[kN]		[mm]			[Kg]	-
1002	1274	150	8780	56400	7,5	7,5	6	465	353901
1005	1280	150	7990	50900	7,5	7,5	6	505	353210
1770	1930	80	3210	31700	5	5	4	250	353312
1828,8	2184,4	203,2	19800	141000	10,2	10,2	9	1450	353320

Screwdown bearings

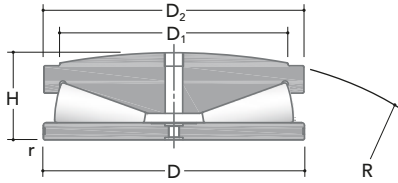

TKSD₁

Main dimensions					Basic load ratings	Dimensions	Mass	Designation
D	D ₁	D ₂	H ± 0,381	R	Static C ₀	r _{min}		
[mm]					[kN]	[mm]	[Kg]	–
203,2	177,8	200,84	75620	508	3930	1,6	16,5	353108
266,7	228,6	264,34	94,41	609,6	7070	1,6	35,5	353038
320,68	279,4	318,31	110,97	762	10250	1,6	61,5	353065
377,83	330,2	375,46	129,01	914,4	14890	1,6	96	353107
409,58	355,6	407,21	140,77	1016	16980	3,2	125	353058
438,15	381	435,79	150,67	1016	19860	3,2	170	353059
495,3	431,8	492,94	170,61	1066,8	25960	3,2	205	353024
	431,8	492,94	170,61	1066,8	25960	3,2	205	353295
508	440	504,825	177,419	1143	30970	2,5	225	353322
523,875	457,2	521,51	175,77	1270	29930	3,2	245	353020
533,4	457,2	533,4	177,8	1981,2	30380	3,2	280	353129
555,63	482,6	553,26	190,86	1270	33090	3,2	275	616674
	482,6	553,26	190,86	1270	33090	3,2	275	353078
	482,6	553,26	205,74	1270	33190	3,2	305	353260
581,03	508	578,66	193,78	1422,4	37270	3,2	290	353124
	508	578,66	196,65	1308,1	37270	3,2	330	353288
609,6	533,4	607,24	204,01	1524	38930	3,2	400	353093
	–	607,24	177,038	–	38930	3,2	375	353262
641,35	560	638,99	178,1	1524	44690	3,2	455	353134
920	830	920	280	2300	91590	7,5	1180	353193

Screwdown bearings

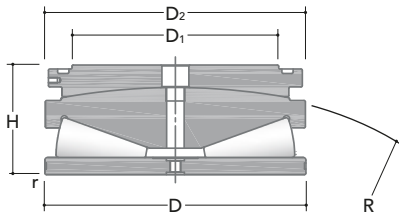

TKSD4

Main dimensions					Basic load ratings	Dimensions	Mass	Designation
D	D ₁	D ₂	H	R	Static C ₀	r _{min}		
[mm]					[kN]	[mm]	[Kg]	—
174,63	150	173	76	457,2	2990	1,5	12	353305
203,2	170	200	90	508	3950	1,1	16,5	353108
266,7	225	264,34	120	609,6	7090	1,6	47	353038
409,58	355	410	188	1016	16950	3,2	170	353058
533,4	410	500	245	1981,2	30450	3,2	360	353129
581,03	460	565	243,78	1422,4	37060	3,2	400	353124
	500	570	243,78	1422,4	37060	3,2	425	353124
609,6	585	710	254,01	1524	38510	3,2	565	353093
641,35	560	635	260	1524	44200	3,2	560	353134
920	768	915	370	2300	92120	7,5	1700	353195

Screwdown bearings

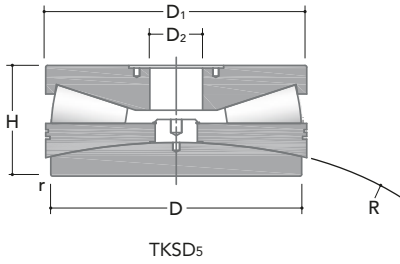

Main dimensions					Basic load ratings	Dimensions	Mass	Designation
D	D_1	D_2	H	R	Static C_0	r_{min}		
[mm]					[kN]	[mm]	[Kg]	-
476	495,3	100	495,3	210	25750	25753	-	353075
515	524	60	520	220	35620	35624	3,3	353231
571,5	581,03	-	581,03	240,77	34880	34887	-	353067
582,625	609,6	-	609,6	249,96	38390	38399	3	353142
	609,6	-	670	248,46	42990	42996	3	353903
740	800	340	800	320	45490	45498	8	353070
775	850	340	850	360	56640	56643	5	353045
830	900	320	900	390	80920	80927	10	353029

Double direction tapered roller thrust bearings

Double direction tapered roller thrust bearings (TTK) can support high bidirectional axial loads and are able to accommodate a small eccentricity between shaft and housing, without affecting negatively their performance. Due to a large number of a tapered rollers, this bearing has also an high rigidity. TTK is available in two main configurations. The first one has two tapered housing washers, a flat shaft washer, two tapered rows of rollers and two two-pieced machined brass cage guided on shaft washer. A spacer sleeve is arranged between the two housing washers in order to adjust the correct bench end play requested by the customer.

A second version has an intermediate washer with external housing centering. Both bearings designs are separable, so washers, cage-tapered rollers assemblies and spacer sleeve can be mounted separately.



Misalignment

Double direction tapered roller thrust bearings featuring a flat washer do not allow any misalignment of the shaft as well as any other perpendicular error of the supporting parts.

Minimum load

A minimum axial load is requested for a double tapered roller thrust bearing, like for all roller bearings, to operate correctly, especially in particularly application requirements like: high speed, high acceleration and sudden changes of direction. In these operating conditions a sliding movement between the rollers and raceways can be generated by the inertial forces, influencing negatively the bearing life. To calculate the minimum axial load please consult the RKB application engineering service.

However, the minimum axial load is reached or surpassed by the weight of the components supported by the bearing, mostly when the shaft is vertical and the loads acting on it. If the minimum axial load is not reached or in case of application where a starting up at low temperature is planned or a lubricant with high viscosity is used, it will be necessary to preload the tapered roller thrust bearing by springs or shaft nut.

For additional information, please consult the RKB application engineering service.

Designs and variants

Type TTK₁

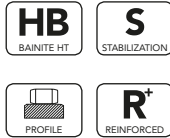

- Separable compact units
- Two-piece machined brass cage (M) guided on shaft washer (intermediate washer)
- Intermediate washer with internal centering on shaft
- Preset or adjusted BEP on customer's request
- Very sensitive to misalignments
- Supports very high bidirectional axial loads
- Available with lubrication grooves and holes in outer spacer

Type TTK_{SP}

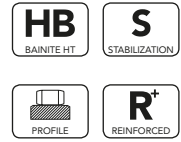
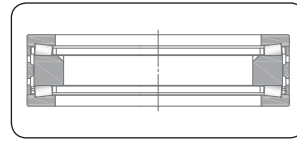

- Separable compact units
- Two-piece machined brass cage (M) guided on shaft washer (intermediate washer)
- Shaft washer with internal centering on shaft
- Preset or adjusted BEP on customer's request
- Very sensitive to misalignments
- Support very high bidirectional axial loads
- Available with lubrication grooves and holes in outer spacer

Type TTK₂

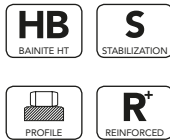
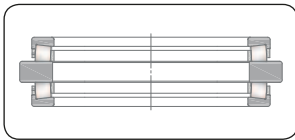

- Low cross section separable compact units
- Two-piece machined brass cage (M) guided on shaft washer (intermediate washer)
- Intermediate washer with external centering on the housing
- Very sensitive to misalignments
- Supports very high bidirectional axial loads

Double direction tapered roller thrust bearings

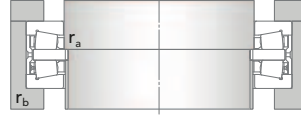
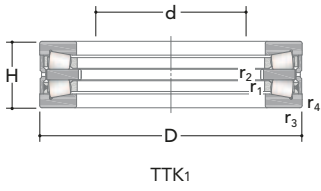

TTK₁

Main dimensions			Basic load ratings		Dimensions				Mass	Designation
d	D	H	Dynamic C	Static C ₀	r _{1,2min}	r _{3,4min}	r _{amax}	r _{bmax}		
[mm]			[KN]		[mm]				[Kg]	-
170	240	84	323	1280	0,6	2	0,6	2	12,5	350980
180	280	90	544	2370	1	2	1	2	22	353162
220	300	96	430	1630	0,6	2	0,6	2	20	351019
240	320	96	402	1880	0,6	2	0,6	2	21,5	351182
250	380	100	870	4500	0,6	2	0,6	2	43,5	353005
260	360	92	586	2590	1	2	1	2	28	350981
270	450	180	1610	5910	2	5	2	4	120	351164
305,07	530	200	2330	10480	6,4	6,4	6	6	185	353194
320	440	108	965	4920	1,1	3	1	2,5	48,5	353102
	470	130	1260	5610	1,1	3	1	2,5	80	350982
350	490	130	1120	5070	1,1	3	1	2,5	73,5	351100
	540	135	1680	9050	1,1	4	1	3	115	353006
380	560	130	1730	9900	1,5	3	1,5	2,5	110	351175
	650	215	3260	16310	2	4	2	3	275	353204
400	650	200	2630	13460	4	4	4	4	235	353106
420	620	170	2350	12120	1,5	3	1,5	3	185	351121
	620	185	2350	12120	1,5	3	1,5	3	200	353200
440	645	167	1910	10640	3	4	2,5	3	190	353152
450	645	155	1920	10580	4	4	3	3	170	350916
470	720	200	3330	17540	2	4	2	3	285	353151
	720	200	3330	17540	2	4	2	3	285	351301
	720	210	3330	17540	2	4	2	3	305	353238
530	710	218	2110	10890	2	3	2	2,5	245	351475
550	760	230	2830	13100	2	5	2	4	310	350976



TTK2



TTKSP

Main dimensions			Basic load ratings		Dimensions				Mass	Designation
d	D	H	Dynamic C	Static C ₀	r _{1,2min}	r _{3,4min}	r _{amax}	r _{bmax}		
[mm]			[kN]		[mm]				[Kg]	-
600	880	290	4620	20940	5	6	4	5	550	350824
	910	290	4610	21110	5	6	4	5	655	350901
670	900	230	3440	18640	2	5	2	4	425	351761

Spherical roller thrust bearings

The spherical roller thrust bearings manufactured by RKB are designed to support high axial loads and, in some cases, even moderate radial loads. The manufacturing program includes single and double direction spherical roller thrust bearings to meet any requirements in various industrial applications. Thanks to the improved internal geometry and the use of the most suitable raw materials, all RKB TBs attain the highest axial load ratings and the best reliability. Depending on application requirements, RKB Bainite Hardening Treatment (HB) and High Temperature Dimensional Stabilization (S) can be applied on bearing rings and rolling elements. The bearing dimensional and running accuracy conforms to ISO/ABMA/GOST specifications.



Single direction spherical roller thrust bearings

Single direction spherical roller thrust bearings are composed by a shaft washer, housing washer and one row of asymmetrical barrel roller with cage. They have a separable design: the cage, rollers and shaft washer together form an assembly, while the housing washer can be mounted separately.

Due to their raceways design, they are self-aligning, making the bearing insensitive to the shaft deflection or misalignment between shaft and housing. Axial spherical roller bearings can accommodate radial and unidirectional axial load acting simultaneously on it, even if they are suitable to work under heavy axial loads and high speed rotation.

They are manufactured mainly in three different configurations, depending on the bearing size. "EM type" with one piece machine brass cage guided on the shaft washer; "EMEVO type" has one piece "EVO" machine brass cage guided on the shaft where the axial forces are transmitted via the cage-guiding sleeve and "EJ type" with one high strength pressed steel cage guided on shaft washer.

In application where the "EMEVO type" bearing has to be replaced with "EM type" or "EJ type", it is necessary to insert a spacer sleeve between the shaft abutment and the shaft washer.

The main boundary dimensions of spherical roller bearings are in conformity with ISO 104:2015. They are manufactured with tolerances according to ISO 199:2014.

Misalignment

Due to its self alignment internal design, the spherical roller thrust bearings can accommodate misalignment between shaft and housing and a shaft bending during the operation. Full capacity of misalignment can be used when the shaft is rotating and the misalignment is constant.

Depending on the configuration, for example the presence of seals or the working conditions, the following values given in **Tab. 1** have to be reduced. Generally speaking the reduced values of misalignment have to be used when the load increases. Contact RKB application engineering service when:

- the housing washer is rotating with misalignment;
- shaft wobbles in relation to the housing.

Minimum load

A minimum axial load is requested for thrust roller bearings, like for all rolling bearings, to operate correctly, especially in particularly application requirements like: high speed, high acceleration and sudden changes of direction. In these operating conditions a sliding movement between the rollers and raceways can be generated by the inertial forces, influencing negatively the bearing life. To calculate the minimum axial load please consult the RKB application engineering service.

However, the minimum axial load is reached or surpassed by the weight of the components supported by the bearing, mostly when the shaft is vertical and the loads acting on it. If the minimum axial load is not reached or in case of application where a starting up at low temperature is planned or a lubricant with high viscosity is used, it will be necessary to preload the spherical roller thrust bearings by springs or shaft nut.

For additional information, please consult the RKB application engineering service.

Bearing series	Maximum misalignment for P or $P_0 < 0.05 \cdot C_{0a}$
292	$\pm 1.5^\circ$
293	$\pm 2.5^\circ$
294	$\pm 3^\circ$

Tab. 1 - Spherical roller thrust bearings max misalignment



Spherical roller thrust bearings

Designs and variants

Type EM

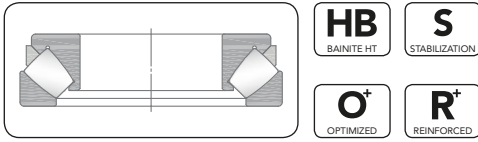

- Asymmetrical roller profile
- One-piece machined brass cage guided on shaft washer (M)
- Reinforced and optimized execution (E)
- Supports unidirectional axial loads and angular misalignment

Type EM_{EVO}

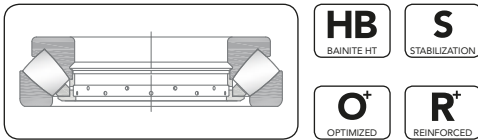

- Asymmetrical roller profile
- One-piece EVO type machined brass cage guided on shaft (M)
- Reinforced and optimized execution (E)
- Supports unidirectional axial loads and angular misalignment

Type EJ

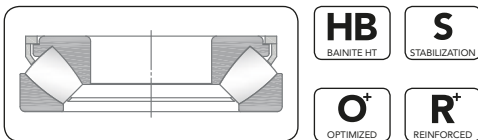

- Asymmetrical roller profile
- High strength pressed steel cage (J) guided on shaft washer
- Reinforced and optimized execution (E)
- Supports unidirectional axial loads and angular misalignment

Suffixes	Internal design
E	Optimized internal design with reinforced execution
EVO	Retaining sleeve with holes and cage guided on housing washer
SP	Special or non-standard bearing
AOB	Application optimized bearing

Suffixes	Cage
M	Machined brass cage guided on shaft washer with or without retaining sleeve
F	Machined steel cage
J	Pressed steel cage

Suffixes	External design
N1	One locating slot in housing washer
N2	Two locating slots in housing washer
EB	Lifting threaded holes for eye bolts in shaft washer

Spherical roller thrust bearings

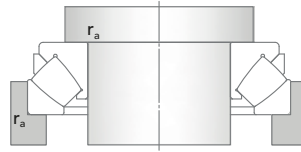
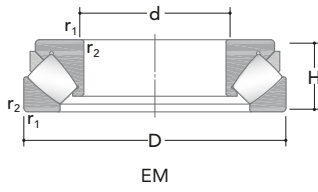

Main dimensions			Basic load ratings		Speed ratings		Dimensions		Mass	Designation
d	D	H	Dynamic C	Static C ₀	Reference	Limiting	r _{1,2min}	r _{amax}		
[mm]			[kN]		[rpm]		[mm]		[Kg]	—
60	130	42	381	903	2700	4200	1,5	1,5	2,6	29412
65	140	45	445	1070	2500	4000	2	2	3,2	29413
70	150	48	507	1230	2300	3600	2	2	3,9	29414
75	160	51	582	1410	2300	3300	2	2	4,7	29415
80	170	54	657	1610	2100	3200	2,1	2	5,6	29416
85	150	39	370	1050	2300	3200	1,5	1,5	2,75	29317
	180	58	720	1790	1900	3000	2,1	2	6,75	29417
90	155	39	390	1070	2300	3300	1,5	1,5	2,85	29318
	190	60	790	1990	1800	2900	2,1	2	7,75	29418
100	170	42	456	1280	2100	3100	1,5	1,5	3,65	29320
	210	67	955	2460	1600	2500	3	2,5	10,5	29420
110	190	48	589	1720	1800	2700	2	2	5,3	29322
	230	73	1140	2970	1500	2300	3	2,5	13,5	29422
120	210	54	738	2080	1600	2400	2,1	2	7,35	29324
	250	78	1340	3440	1400	2200	4	3	17,5	29424
130	225	58	842	2480	1500	2200	2,1	2	9	29326
	270	85	1500	3990	1200	2000	4	3	22	29426
140	240	60	950	2820	1400	2200	2,1	2	10,5	29328
	280	85	1580	4210	1200	1900	4	3	23	29428
150	215	39	398	1570	1700	2300	1,5	1,5	4,3	29230
	250	60	970	2820	1400	1900	2,1	2	11	29330
	300	90	1800	5050	1100	1800	4	3	28	29430
160	270	67	1140	3380	1200	1800	3	2,5	14,5	29332
	320	95	2020	5510	1000	1600	5	4	32	29432
170	280	67	1150	3510	1200	1800	3	2,5	15	29334
	340	103	2290	6430	1000	1600	5	4	44,5	29434



EMevo



EJ

Main dimensions			Basic load ratings		Speed ratings		Dimensions		Mass	Designation
d	D	H	Dynamic C	Static C ₀	Reference	Limiting	r _{1,2min}	r _{amax}		
[mm]			[kN]		[rpm]		[mm]		[Kg]	–
180	250	42	481	2020	1500	2200	1,5	1,5	5,8	29236
	300	73	1390	4240	1100	1600	3	2,5	19,5	29336
	360	109	2520	7210	970	1500	5	4	52,5	29436
190	320	78	1560	4660	1000	1500	4	3	23,5	29338
	380	115	2750	7900	910	1400	5	4	60,5	29438
200	280	48	641	2640	1300	1800	2	2	9,3	29240
	340	85	1820	5490	970	1400	4	3	28,5	29340
	400	122	3120	8970	830	1300	5	4	72	29440
220	300	48	672	2980	1200	1800	2	2	10	29244
	360	85	1940	6190	970	1400	4	3	31	29344E
	420	122	3270	9530	830	1200	6	5	75	29444
240	340	60	783	3410	1000	1500	2,1	2	16,5	29248
	380	85	1990	6540	970	1300	4	3	35,5	29348
	440	122	3300	10110	820	1200	6	5	80	29448
260	360	60	800	3640	1000	1400	2,1	2	18,5	29252
	420	95	2470	8210	820	1100	5	4	49	29352E
	480	132	3930	12790	720	1000	6	5	105	29452
280	380	60	840	3970	970	1400	2,1	2	19,5	29256
	440	95	2460	8610	820	1100	5	4	53	29356
	520	145	4730	15080	640	990	6	5	135	29456
300	420	73	1040	4730	870	1100	3	2,5	30,5	29260
	480	109	2990	10440	720	990	5	4	75	29360
	540	145	4860	16480	650	1000	6	5	140	29460
320	440	73	1070	5040	820	1100	3	2,5	33	29264
	500	109	3240	11050	720	990	5	4	78	29364
	580	155	5500	18730	570	930	7,5	6	175	29464
340	460	73	1090	5370	820	1000	3	2,5	33,5	29268
	540	122	2640	10960	580	940	5	4	105	29368
	620	170	6530	22050	540	840	7,5	6	220	29468
360	500	85	1400	6750	720	1000	4	3	52	29272
	560	122	2680	11530	580	910	5	4	110	29372

Spherical roller thrust bearings

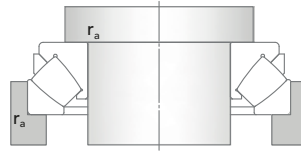
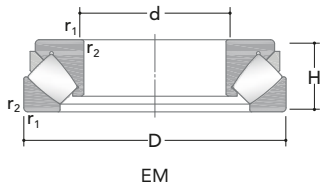

Main dimensions			Basic load ratings		Speed ratings		Dimensions		Mass	Designation
d	D	H	Dynamic C	Static C ₀	Reference	Limiting	r _{1,2min}	r _{amax}		
[mm]			[kN]		[rpm]		[mm]		[Kg]	—
360	640	170	6040	20870	540	800	7,5	6	230	29472
380	520	85	1520	7620	670	920	4	3	53	29276
	600	132	3210	13880	500	830	6	5	140	29376
	670	175	6620	23610	510	750	7,5	6	260	29476
400	540	85	1540	7930	670	900	4	3	55,5	29280
	620	132	3310	14470	500	800	6	5	150	29380
	710	185	7400	26160	460	720	7,5	6	310	29480
420	580	95	1930	9610	610	850	5	4	75,5	29284
	650	140	3610	15770	480	760	6	5	170	29384
	730	185	7570	26990	460	700	7,5	6	325	29484
440	600	95	2010	10330	610	840	5	4	78	29288
	680	145	5000	18950	500	720	6	5	180	29388
	780	206	8780	31570	410	610	9,5	8	410	29488
460	620	95	2000	10560	570	800	5	4	81	29292
	710	150	4190	18670	430	690	6	5	215	29392
	800	206	9080	33400	420	630	9,5	8	425	29492
480	650	103	2270	11760	540	750	5	4	98	29296
	730	150	4240	19240	430	680	6	5	220	29396
	850	224	9300	38380	330	570	9,5	8	550	29496
500	670	103	2300	12320	540	750	5	4	100	292/500
	750	150	4370	20070	410	670	6	5	235	293/500
	870	224	8990	39600	320	560	9,5	8	560	294/500
530	710	109	2990	15060	510	710	5	4	115	292/530
	800	160	5100	23520	390	630	7,5	6	270	293/530
	920	236	10180	43990	310	520	9,5	8	650	294/530
560	750	115	2880	15770	460	660	5	4	140	292/560
	980	250	11550	50130	280	470	12	10	810	294/560
600	800	122	3640	18480	430	590	5	4	170	292/600
	1030	258	12650	55190	270	440	12	10	845	294/600
630	850	132	4620	23130	380	570	6	5	210	292/630



EMEvo



EJ

Main dimensions			Basic load ratings		Speed ratings		Dimensions		Mass	Designation
d	D	H	Dynamic C	Static C ₀	Reference	Limiting	r _{1,2min}	r _{amax}		
[mm]			[kN]		[rpm]		[mm]		[Kg]	–
630	950	190	8250	37490	310	520	9,5	8	485	293/630
	1090	280	13950	61330	250	410	12	10	1040	294/630
670	900	140	4090	22460	370	530	6	5	255	292/670
	1150	290	14880	67760	230	380	15	12	1210	294/670
710	1060	212	9710	44890	270	430	9,5	8	610	293/710
	1220	308	17030	76360	210	370	15	12	1500	294/710
750	1000	150	5960	30950	330	470	6	5	325	292/750
	1120	224	9050	44370	250	400	9,5	8	770	293/750
	1280	315	18060	84640	190	330	15	12	1650	294/750
800	1060	155	6410	34420	310	430	7,5	6	380	292/800
	1180	230	9640	48480	230	380	9,5	8	865	293/800
	1360	335	19430	92250	180	290	15	12	2030	294/800
850	1120	160	6480	35790	280	410	7,5	6	425	292/850
	1440	354	23310	107500	160	290	15	12	2390	294/850
900	1180	170	7520	42140	260	380	7,5	6	475	292/900
	1520	372	25800	121500	150	250	15	12	2650	294/900
950	1250	180	8020	45460	250	350	7,5	6	600	292/950
	1600	390	27200	131200	130	230	15	12	3070	294/950
1000	1670	402	29990	137800	120	210	15	12	3390	294/1000
1060	1400	206	10130	58190	210	310	9,5	8	860	292/1060
	1770	426	32390	155900	110	200	15	12	4280	294/1060
1180	1520	206	10460	62740	210	280	9,5	8	950	292/1180
1250	1800	330	24300	127700	120	190	12	10	2770	293/1250
1600	2280	408	35380	196300	87	130	19	15	5380	293/1600

RKB

BEARING INDUSTRIES
SWITZERLAND

Via Primo Agosto · 6828 Balerna · Switzerland
P.O. Box 16 · 6830 Chiasso 3 · Switzerland
Phone +41 91 260 09 30 · Fax +41 91 260 09 50
info@rkbeurope.com · www.rkbbearings.com

The Alternative Power

